

RETAINERS
CAMSHAFTS
RACING
TECHNOLOGY
LIFTERS
HORSEPOWER
TORQUE
VALVE SPRINGS
PUSHRODS
MUSCLE CAR
HOT ROD
CAMSHAFTS
RACING
TECHNOLOGY
HORSEPOWER
TORQUE
VALVE SPRINGS
PUSHRODS
QUALITY
VALVE TRAIN
PERFORMANCE
ROCKER ARMS
MUSCLE CAR

Engineered To Finish First.

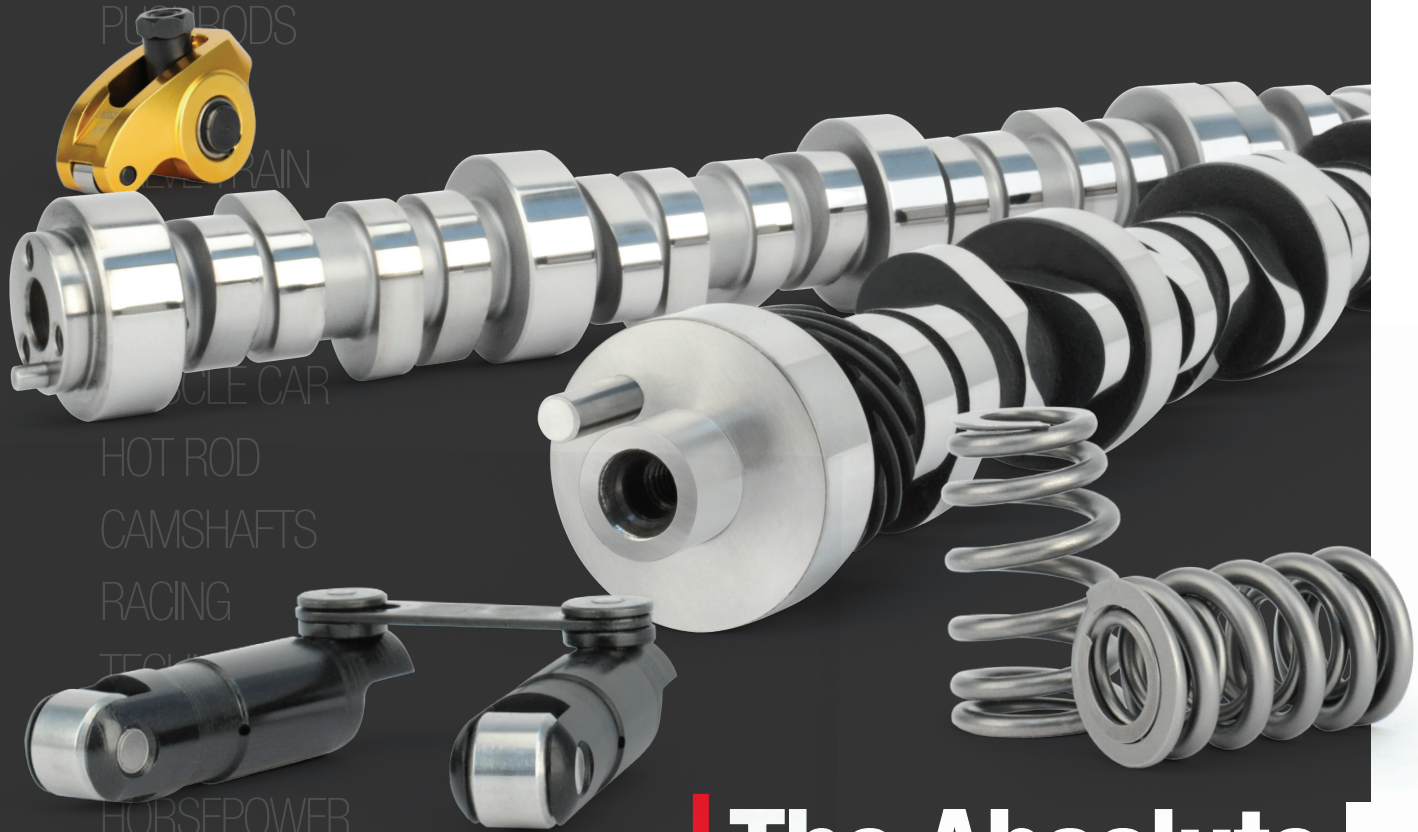

**MASTER
REFERENCE
GUIDE**

The Absolute Leader In Valve Train Technology

COMPCAMS.COM | 1.800.999.0853

HOT PRODUCTS

HOT PRODUCTS

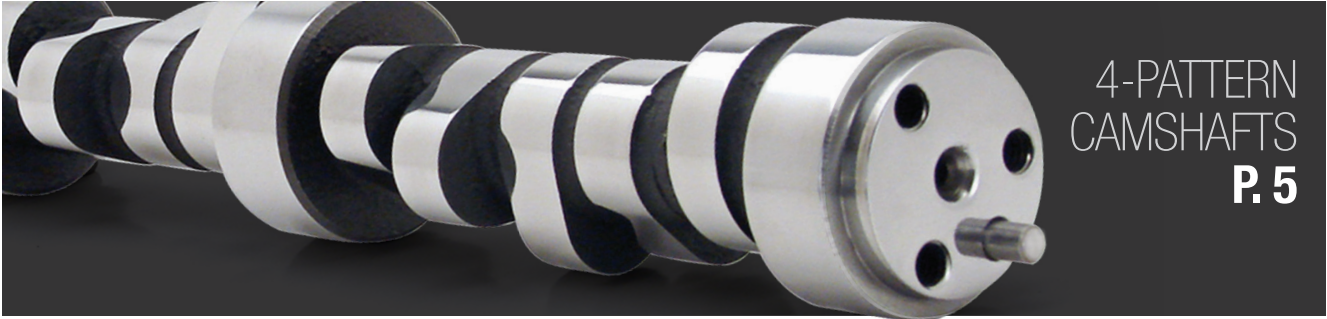

4-PATTERN
CAMSHAFTS
P. 5

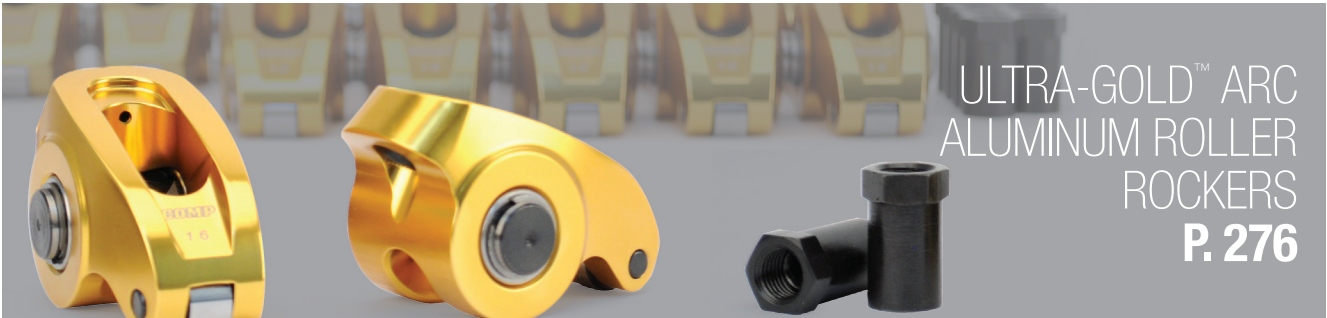

ULTRA-GOLD™ ARC
ALUMINUM ROLLER
ROCKERS
P. 276



SHORT TRAVEL
HYDRAULIC ROLLER
LIFTERS
P. 243



VALVE
SPRING
KITS
P. 288

TECHNICAL ASSISTANCE is available through a variety of sources:

Toll Free CAM HELP®: 1.800.999.0853

Website: www.compcams.com (Live Chat & Forum)

Email: camhelp@compcams.com

Twitter: @CPGTech

CAMHELP.COM

Technical & Sales Personnel are available from 7:00 a.m. to 8:00 p.m. CT, Monday through Friday and from 9:00 a.m. to 4:00 p.m. on Saturday. COMP Cams® is closed on Sunday and legal holidays

TECHNICAL RESOURCES

Camshaft Series.....	4
Camshaft Special Services.....	232
Chrysler Camshaft Tech.....	6
CPG Nation™.....	352
Ford Camshaft Tech.....	40
GM LS Application Chart.....	162
GM Camshaft Tech.....	100
Lifter Tech.....	236
Literature.....	351
Kit Components.....	3
Pushrod Tech.....	254
Rocker Arm Tech.....	270
Timing Tech.....	313
Valve Spring Tech.....	285
Warranty Policy.....	350
APPAREL.....	347
Banner.....	346
Book.....	346
Cam Bearings.....	323
Cam Bearing Installation Kit.....	323
Cam Bearing Installation Tool.....	323
Cam Bearing Spacers.....	323
CAMSHAFTS.....	6
American Motors Cams.....	8, 226
Chrysler Cams.....	12, 227
Chrysler 4 & 6 Cyl.....	12
Chrysler 273-360.....	14, 227
Chrysler 383-440.....	26, 228
Chrysler 392 Hemi.....	36, 228
Chrysler 426 Hemi.....	36, 228
Dodge 5.7L, 6.1L & 6.4L Hemi.....	26
Dodge V10.....	38
Ford Cams.....	40, 228
Ford 4 & 6 Cyl.....	42, 228
Ford 4.6L & 5.4L DOHC Modular 2V.....	46
Ford 4.6L & 5.4L DOHC Modular 3V.....	48
Ford 4.6L & 5.4L DOHC Modular 4V.....	52
Ford 5.0L.....	62, 229
Ford Coyote 5.0L DOHC Modular 4V.....	54
Ford 221-302.....	56, 229
Ford 332, 352, 390, 406.....	84, 230
Ford 351C, 351M-400M.....	78, 229
Ford 351W.....	68, 229
Ford 352-428.....	84, 230
Ford 427 SOHC.....	88
Ford 429-460.....	90, 230
Ford Flathead (2 Gear) 239, 255.....	46
Ford Y-Block 292, 312.....	46
GM Cams.....	100, 226
Buick.....	102, 226
Cadillac.....	106

Chevrolet 4 & 6 Cyl.....	108, 226
Chevrolet 262-400.....	116, 226
Chevrolet 348-409.....	178, 227
Chevrolet 396-454.....	180, 227
Chevrolet 6600/6.6L.....	206
Chevrolet 8100/8.1L.....	206
Chevrolet Gen VI 454 & 502.....	202
GM 3800/3.8L 6 Cyl.....	112
GM LS.....	166
GM LS Application Chart.....	162
GM LT1 & LT4 V8.....	160
GM LTI Gen V.....	178
Harley Davidson Cams.....	220, 230
Holden Cams.....	230
Honda/Acura Cams.....	222
International Harvester Cams.....	222
Mitsubishi Cams.....	224, 230
Nissan Cams.....	225, 231
Oldsmobile Cams.....	208, 231
Pontiac Cams.....	212, 231
Toyota Cams.....	225, 231
Volkswagen Cams.....	231
Coil Covers.....	324
Decals.....	346
Distributor Gears.....	233
DVD.....	346
Engine Finishing Kits.....	324
Fender Cover.....	346
Fluids.....	234
Fuel Pump Pushrods.....	325
Hats.....	347
Hose Clamps.....	326
LIFTERS.....	236
Elite Race™ Solid Roller Lifters.....	250
Endure-X™ Solid Roller Lifters.....	245
High Energy™ Hydraulic Flat Tappet Lifters.....	238
Hi-Tech™ Hydraulic Flat Tappet Lifters.....	239
Hydraulic Flat Tappet Lifters.....	238
Hydraulic Roller Lifter Installation Kits.....	244
Hydraulic Roller Lifters.....	242
Hydraulic Roller Kits.....	244
Hydraulic Roller Retro-Fit Kit.....	244
Lifter Tech.....	236
Link Bars.....	249
Performance Series™ Solid Flat Tappet Lifters.....	241
Pro Magnum™ Hydraulic Flat Tappet Lifters.....	239
Pushrod Seats.....	253
Race Hydraulic Flat Tappet Lifters.....	239
Short Travel Hydraulic Roller Lifters.....	243
Solid/Mechanical Flat Tappet Lifters.....	240
Solid/Mechanical Roller Lifters.....	245
Tool Steel Solid/Mechanical Flat Tappet Lifters.....	240

Lifter Valley Standpipe.....	325
Literature.....	351
Lubricants.....	234
Merchandise.....	346
Oils.....	234
Oil Restrictors.....	325
PUSHRODS.....	254
.105" Wall Pushrods.....	264
.125" Wall Pushrods.....	266
.135" Wall Pushrods.....	265
210° Radius Pushrods.....	262
Checking Pushrods.....	255
Dual Taper Pushrods.....	266
High Energy Pushrods™.....	256
Hi-Tech™ Pushrods.....	260
Magnum Pushrods.....	258
Oil Restricting One-Piece .080" Wall Pushrods.....	264
Pushrod Length Checkers.....	255
Pushrod Tech.....	254
Pushrod Tools/Accessories.....	267
Semi-Finished Pushrods.....	268
Straight Tube Pushrods.....	266
Reference Material.....	346
ROCKER ARMS.....	270
Adjusting Nuts.....	281
Aluminum Rocker Arms.....	275
GM LS Rocker Arm Kits.....	274
Guide Plates.....	284
High Energy™ Die Cast Aluminum Roller Rocker Arms.....	275
High Energy Steel Rocker Arms™.....	275
Magnum Rocker Arms.....	271
Polylocks.....	281
Rev Kits.....	284
Rocker Arm Adjusting Nut Kits.....	281
Rocker Arm Adjusting Nuts.....	281
Rocker Arm Kits.....	280
Rocker Arm Studs.....	282
Rocker Arm Stud Upgrade Kit.....	273
Rocker Arm Tech.....	270
RP Kits.....	280
Shaft Mount Rocker Arms.....	278
Steel Rocker Arms.....	271
Stud Boss Cutter.....	282
Stud Girdles.....	283
Trunnion Upgrade Kit.....	274
Ultra-Gold™ ARC Aluminum Roller Rocker Arms.....	276
Ultra Pro Magnum™ Chrysler Shaft Mount Rocker Arms.....	274
Ultra Pro Magnum™ Roller Rocker Arms.....	272
Ultra Pro Magnum™ XD Roller Rocker Arms.....	273

2 | TABLE OF CONTENTS



Software.....	343	Connecting Rod Balancer	337	VALVE SPRINGS & RETAINERS	285
SPRINGS.....	SEE VALVE SPRINGS	Crank Gear Installation Tool	337	Beehive™ Valve Springs	289
TIMING SETS	313	Crankshaft Nut Assemblies	329	Beehive™ Valve Spring Kits	288
Adjustable Cam Gear Set	314	Crankshaft Sockets	327	Conical Valve Springs	290
Adjustable Timing Sets & Chains	317	Cylinder Head Holders	338	Cups	309
Belt Drives.....	320	Cylinder Head CC Kits.....	338	Dual Valve Spring Kits.....	288
Belt Tensioners.....	319	Deck Checker.....	341	Dual Valve Springs.....	291
Cam Bolts.....	322	Degree Kits	327	GM LS Engine Valve Spring Kits	288
Cam Lock Plates	322	Degree Wheels	327	Honda/Acura DOHC Valve Spring Kits.....	292
Cam Phaser Limiter Kits	314	Dial Bore Gauge Combo.....	342	Kits	288
Degree Bushings	322	Dial Indicators & Accessories.....	341	Lash Caps	307
Front Covers.....	321	Digital Protractor	341	Locators.....	309
Front Drive Kit	319	Dual Feeler Gauge Handle	340	Locks	307
Gear Drives	319	Engine Oil Pump Primers	333	Master Valve Spring Chart	293
Gear Sets	319	Harmonic Balancer Installation Tools.....	337	Oil Seals.....	311
GM LS Timing Sets for Raised Cam Blocks	318	Lifter Bore Grooving Tool.....	330	Ovate Wire Valve Springs	290
High Energy™ Timing Sets & Chains.....	315	Lifter Bushing Installation Tool	331	Performance Valve Springs	286
Hi-Tech™ Roller Race Timing Sets & Chains	316	Lifter Case.....	333	Retainers.....	304
Keyway Adjustable Billet Timing Sets.....	317	Louis Tool	340	Seals.....	311
Magnum Double Row Timing Sets & Chains	315	Micrometers.....	336	Seats.....	309
Thrust Bearings.....	322	Pro Valve Lock Tools	332	Seat Spacers.....	310
Thrust Buttons.....	322	Pushrod Assembly Tool.....	331	Shims.....	310
Timing Chains	315	Remote Starter Switch.....	340	Single Valve Springs	290
Timing Covers	321	Rocker Stud Puller & Tap Guide	332	Spring Seat & Guide Cutters/Arbors.....	311
Timing Tech.....	313	Seal Setters.....	332	Steel Retainers.....	304
Ultimate Adjustable Billet Timing Sets	318	Telescoping Gauge Set	342	Titanium Retainers	306
Wear Plates.....	322	Top Dead Center Stops	329	Tool Steel Retainers.....	305
TOOLS	327	Torque Wrenches.....	339	Triple Valve Springs	292
Calipers.....	342	Valve Lash Wrenches.....	339	Valve Lash Caps	307
Cam Checking Fixture.....	330	Valve Seal Installation Tool.....	332	Valve Locks	307
Cam Checking Tools	329	Valve Spring Compressors.....	334	Valves	312
Cam Degree Kits	327	Valve Spring Removers.....	334	Valve Spring Accessories.....	310
Cam Degree Wheels	327	Valve Spring Testers	336	Valve Spring Chart.....	293
Cam Installation Handles	331	Valve Spring Organizer Trays	333	Valve Spring Tech	285
Cam Lobe Marking Tool Set	329	T-Shirts.....	347	Warranty Policy.....	350
Checking Springs	328	Vacuum Canisters/Pump Kit.....	325	Wearables.....	347
		Valve Covers.....	324		

IMPORTANT NOTICE

This catalog has been completed using our best efforts. All product photos are for illustrative purposes only. Featured photos may contain optional items that are not included in the purchase of the product. We assume no liability for errors contained herein. The catalog on our website is updated on a regular basis and should be used to supplement the information contained herein.

It is the responsibility of the installer to ensure that all of the components are correct before installation. Proper assembly always requires that the installer measure all tolerances for proper clearance. We assume no liability for any errors made in component selection or installation.

Prices on all products are subject to change without notice. We reserve the right to make changes in products at any time. Except as noted, products in this catalog may not be legal for sale or use in pollution-controlled motor vehicles (pre-1966 domestic vehicles certified to California standards, pre-1968 domestic vehicles certified to federal standards.)

This catalog, the information contained herein, and our part numbers used are copywritten by Competition Cams, Inc. 2013.

CAM KITS

COMP Cams® offers four levels of complete component-matched valve train kits that deliver unbeatable performance, durability and ease of installation.

K-KIT – COMPLETE KIT

SK-KIT – SMALL KIT

GK-KIT – GEAR DRIVE KIT

CL-KIT – CAM & LIFTER KIT

All cam kits are fully tested and manufactured to the strictest standards. Each kit's components were specifically chosen as the best performance match for that particular camshaft so that you can reap the benefits of a perfectly matched "Power Engineered System."

Ordering is easy. Upon selecting the proper camshaft for your application, simply add the kit prefix ("K", "SK", "GK" or "CL") in front of your cam part number. For example, if you choose cam Part #12-206-2 and you want the complete kit, you should order Part #K12-206-2.

* Please note that not all kits are available for every part numbered camshaft. See the application charts on the following pages to determine which kits are available for your application.

** Contents of kits may vary from application to application; components shown are typical examples. Ask for specific kit contents before ordering.

K-KIT – COMPLETE KIT INCLUDES:

- Camshaft
- Lifters
- Valve Springs
- Retainers
- Valve Locks
- Valve Stem Seals
- Timing Chain Set
- Assembly Lube
- Decals
- Instructions



SK-KIT – SMALL KIT INCLUDES:

- Camshaft
- Lifters
- Timing Chain Set
- Assembly Lube
- Decals
- Instructions



GK-KIT – CAM & GEAR KIT INCLUDES:

- Camshaft
- Lifters
- Gear Drive
- Assembly Lube
- Decals
- Instructions



CL-KIT – CAM & LIFTER KIT INCLUDES:

- Camshaft
- Lifters
- Assembly Lube
- Decals
- Instructions



ROCKER ARM KITS

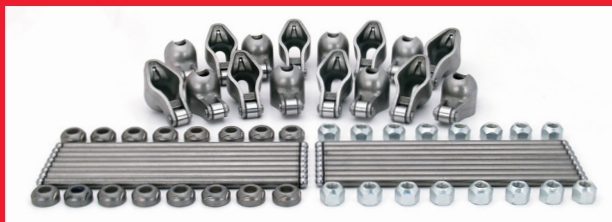

All rocker arm kits include quality COMP Cams® roller rocker arms and matching pushrods. Some applications also come with precision guide plates and rocker arm studs. Consult the related components section of your camshaft of choice to determine if a rocker kit is available.

VALVE SPRING KITS



These valve spring kit offerings include carefully matched Beehive™ or dual valve springs, steel or titanium retainers, locks, seals and spring seats. Please see page 288 for specific kit components and application listings.



CAMSHAFT SERIES DESIGNATIONS

Xtreme Energy™

- Quicker opening lobe profiles deliver increased responsiveness & more area under the lift curve
- More vacuum allows an increase in duration for improved performance and assists power brakes
- Excellent performance in street carbureted applications
- Best performance with aftermarket intake manifolds, headers, lower gear ratios, etc.

LS_R™

- Take advantage of today's newer and better flowing aftermarket cylinder heads
- Feature higher exhaust duration and overall lift to provide broadest powerband and most top end power of any COMP Cams® LS camshaft
- Unique grinds for both cathedral & rectangle port heads
- Require 26926-16 high pressure valve springs

Thumpr™

- Three unique cam designs for each application that deliver excellent horsepower gains and broad torque curve; perfect choice for muscle cars and street rods
- Early intake valve opening and long exhaust duration create optimum overlap for powerful, hard-hitting exhaust note
- Best with aftermarket converters and more rear gear

High Energy™

- Work well with mainly stock components (rockers, manifolds, heads, compression, converters, gears, etc.)
- Good blend of efficiency and performance
- Perfect choice for performance street rebuilds

Magnum

- Great high RPM power
- Easy on valve train parts
- Can be used with mild ratio rocker arms and traditional performance valve springs
- Best with aftermarket converter and 9.5:1+ compression

XFI™

- Newest and quickest lobe profiles in the Xtreme family; provide a terrific increase in performance
- Tuned for use in EFI applications where extra air flow signal through the carburetor is not required (feature wider lobe separation without loss of responsiveness)
- Work well with aftermarket cylinder heads & feature high lift

Xtreme Marine™

- Extremely wide powerband helps get boat on plane while making maximum horsepower
- Work against exhaust systems with restrictive back pressure
- Power enhancement helps maintain top end speed for long distances
- Intended for applications where low idle speeds are required

Xtreme 4x4™

- Improved throttle response and increased low & mid-range RPM horsepower for towing and off-road
- Designed for use with common restrictive factory exhaust systems, including OEM exhaust manifolds

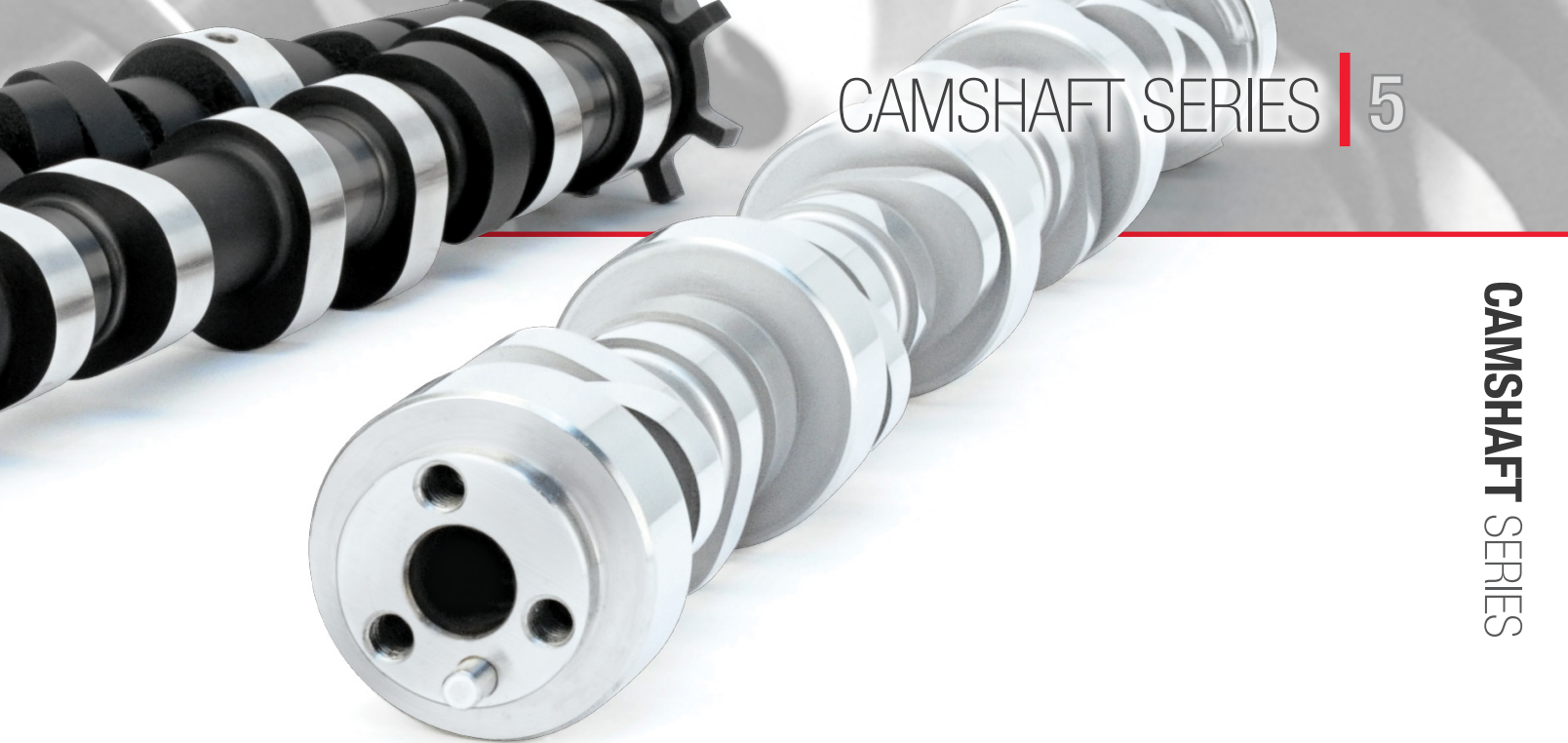

Nitrous HP™

- Wider lobe separation and added exhaust duration from base XE series help shift the power to higher RPM to allow use in nitrous applications
- Early exhaust opening helps scavenge the extra spent gases from nitrous or forced induction
- Better time slips for nitrous passes at the strip

Computer Controlled

- Wide variety of sizes available for significant power gains
- Available for electronic fuel injected, throttle body injected and tuned port injected engines
- Available for both stock and modified computer systems

Nostalgia Plus™

- Specifically designed to capture the essence of the original 1960s muscle car experience
- Combine famous factory cam performance with modern camshaft lobe designs for increased throttle response
- Excellent sound improvement through camshaft specifications (with similar vacuum characteristics to its muscle car era counterparts)

Factory Muscle™

- Reproduction of factory original muscle car camshaft
- Maintain efficiency and drivability of engines
- New computer controlled aided design avoids previous factory design compromises
- Tailored to work with the high compression engine of the 1960s and 70s to produce rough idle

Dual Energy™

- Similar to High Energy Cams™ but better at high RPM when coupled with headers because of added exhaust duration
- Work great with most stock components
- Very flat torque curve for great streetability

Tri-Power Xtreme™

- Three different camshaft designs targeted to improve horsepower, torque or fuel efficiency
- By decreasing pumping losses, efficiency and performance are enhanced, regardless of camshaft selected
- Designed for factory fuel injected engines; use programmer for best mileage gains

Xtreme Turbo

- Help build pressure between engine and turbo for faster spool up in OEM or aftermarket
- Deliver wide powerband without compromising peak power
- Designed to focus on systems with similar boost to back pressure ratios as seen on most modern turbo systems

4-Pattern

- Optimize valve events based on runner length
- Feature a large increase in both area under the curve and stability at high RPM
- Feature four lobe patterns; one intake & exhaust design for outboard runners and another intake & exhaust design for inboard runners
- Technology developed and race-proven in NASCAR



Chrysler, one of the most dominant names during the early “Muscle Car” era, has developed five basic series of engines which are popular choices in racing, street performance, and towing applications. For our purposes we will refer to the 273-360 Small Block Chrysler engines as the “A” engines and the 383-440 big block standard head engines as the “B” engines. Several versions of the Hemi engine were manufactured in the 50s and 60s, and in recent years, the engineers at Chrysler have introduced three versions of the V10 engine platform, as well as a new 5.7L and 6.1L Hemi design. In the following information we have attempted to pass along some common tips learned during our many years of engine building, as well as the experiences of many of our customers. We will not attempt to cover all of the little things, only the more unique and aggravating trouble spots. If ever in doubt, there are many excellent reference manuals. Mopar Performance has one of the best. It goes into great detail about Chrysler engines.

ENGINE TYPES

Small Block, “A”, Uses “20” Prefix

The basic 273-360 engines produced in the mid 1960s have remained relatively unchanged as far as the valve train is concerned. The 1964-1991 engines used shaft type rocker arms, which required some special changes in the camshaft design to allow oil to flow to the top of the engine and into the rocker arm shafts. Most of these early engines featured either grooved or offset holes in the second and fourth cam journals. In some instances a combination of both grooves and holes were employed. You must remember that if your engine has shaft type rockers arms, there must be some groove or oiling hole combination on the cam journals. In 1992 the Magnum version of the “A” engine was changed to a pedestal-style individual rocker arm design with a non-adjustable valve train.

5.7L and 6.1L Hemi, Uses “112” and Prefixes “201”

In 2003 Chrysler called on the legendary Hemi cylinder head design to begin a new era in Mopar performance. This engine has the same familiar perpendicular valve arrangement but does not share any parts with the classic Hemi engine. Rocker arms are shaft mounted with a 1.6 ratio on intake and exhaust. Two rocker shafts per head are used, which is similar to the earlier Hemi. Because of this design, different length intake and exhaust pushrods are used. The newer engine also uses smaller, .842" diameter hydraulic roller lifters and a single bolt cam sprocket.

There are concerns when installing aftermarket camshafts in these engines. The factory piston has a dome and no valve reliefs. Extra caution should be taken to ensure adequate piston to valve clearance. It is also

necessary to deactivate the MDS (multiple displacement system) when installing and using a performance camshaft. Computer tuning must be performed to enhance drivability. In 2010, Chrysler released 5.7L, 6.1L and 6.4L Hemis that utilize Variable Valve Timing (VVT) technology to manage oil flow to a camshaft sprocket which contains a phasing device to either advance or retard camshaft timing. This no springs required design is perfect for Dodge Challengers and Chargers, Chrysler 300s, Jeeps, Dodge trucks and Mopar crate engines.

Big Block “B” or “RB”, Uses “21” and “23” Prefixes

The “B” and “RB” engines use two different deck height blocks. They require different length pushrods, so when considering pushrod length, remember that the 383-400 engines use a shorter pushrod than the 413-440 engines. The larger engines with the taller blocks use a pushrod that is approximately $\frac{3}{4}$ " longer than the other.

When converting either of these engines to adjustable rocker arms, you must also replace the pushrods. The standard pushrod used with non-adjustable rocker arms uses a pushrod with a ball on each end. COMP Cams® aluminum roller rocker arms use a pushrod with a ball on the lifter end and a cup on the rocker arm end. The COMP Cams® Ultra Pro Magnum Rocker Arm™ Kit for these engines requires a ball-ball pushrod like the standard setup, but the length is different. In either case, the correct pushrods must be used for the rocker arm type selected.

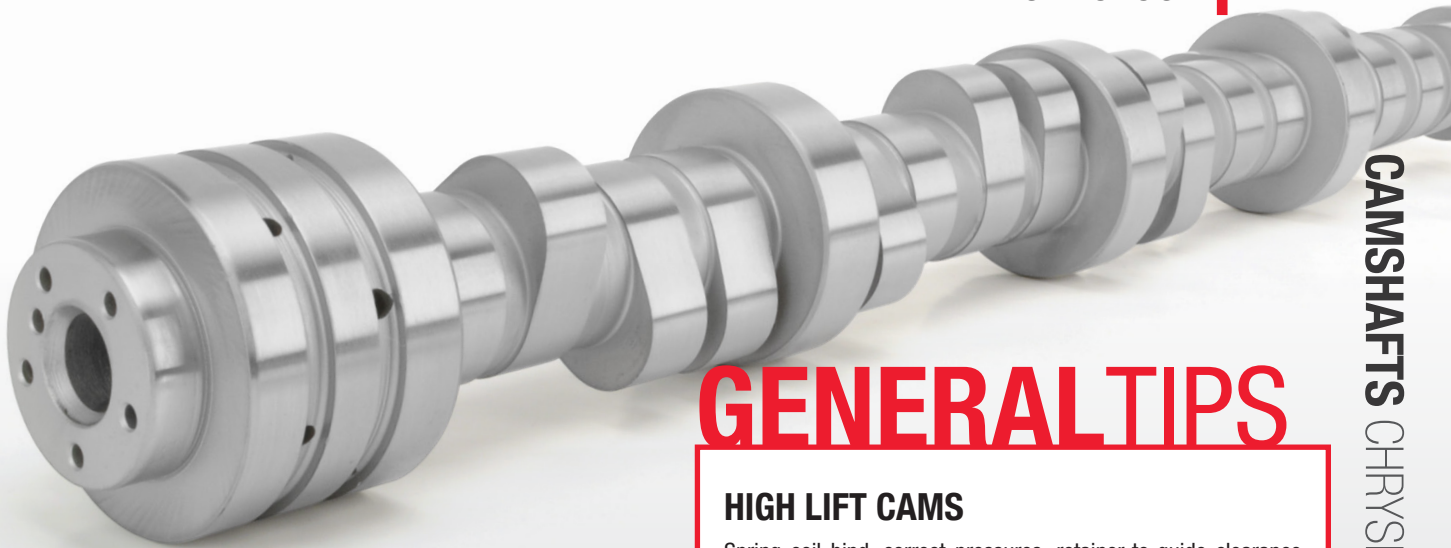

GENERAL TIPS

HIGH LIFT CAMS

Spring coil bind, correct pressures, retainer-to-guide clearance and piston-to-valve clearance are just a few of the more common considerations. There is no exact formula to tell when you are getting into trouble, so to avoid serious problems, it is better to double check these things when installing a cam. If ever unsure, contact COMP Cams® by one of the means listed.

ROCKER ARM GEOMETRY

Proper rocker arm geometry is necessary to ensure the maximum benefit from any cam design. Camshaft base circle, block deck height, cylinder head design and lifter design all contribute to possible errors in geometry, which must be compensated for with pushrod length and rocker shaft height. Usually, a longer than stock pushrod will be necessary in a high performance engine, but care must be taken to choose the correct length.

FUEL PUMP PUSHROD

All Chrysler "B", "RB" and Hemi engines use a fuel pump pushrod to actuate the fuel pump. The fuel pump must be removed and the rod dropped away from the cam prior to camshaft removal. Failure to do so will result in damage to the cam, pushrod or both.

ROCKER ARM ADJUSTMENT/ LIFTER PRE-LOAD

All but a few Chrysler engines were equipped at the factory with non-adjustable rocker arms. Anytime a solid lifter camshaft (either roller or flat tappet) is used, you must also use adjustable rocker arms and appropriate pushrods.

When installing any high performance hydraulic camshaft, the lifter pre-load is something which must be considered. Too little pre-load will result in a noisy valve train while too much pre-load will result in tight valves and a poorly running engine. Either condition can hurt the performance or cause engine failure. After the cam, lifters and rocker arms are installed, and prior to installing the intake manifold, you must check the plunger depression in the lifters. With the cam on the base circle (valve closed), the plunger in the lifters should be depressed .040"-060". With non-adjustable rocker arms, you must change pushrod lengths to obtain proper lifter pre-load. There are also some premium hydraulic lifters that require different amounts of pre-load so be sure to contact COMP Cams® to make sure you know the proper pre-load for your lifters.

Hemi, Uses "24" and "26" Prefixes

There are two basic versions of the original Hemi engine. The most common is the 426 Hemi, which was introduced in 1964 and uses the "24" prefix. Derivatives of this engine can be found in almost all Alcohol and Fuel cars racing today. One of the most popular drag racing engines, it is easily recognizable by the distributor location, which is in the front of the block. As far as production engines are concerned, most of the parts are interchangeable. Hybrid Hemis, however, have relatively few interchangeable parts because most are custom made.

The old style 301-392 Hemi engine, which uses the "26" prefix, is most readily recognized by the location of the distributor at the rear of the block. There were several versions of this engine; therefore it is highly recommended that before ordering any parts you make sure exactly which engine you are working on. These engines were very popular in the 60s and 70s and can still be found in many street machines and street rods, but they are becoming very hard to maintain due to the lack of replacement parts available.

V10, Uses "97" & "111" Prefixes (Viper)

We have two different cores for this engine, depending on the year model. The 2002 and older blocks use a single-bolt core, and the 2003 and later cores are a three-bolt design.

AMC 290-401 V8, Uses "10" Prefix

AMC produced many short deck and tall versions of these engines in the 60s, 70s and 80s. The 360 was the last American-made carbureted engine and was in production until 1991. The AMC V8 is still seen today in many racing applications in AMXs, Javelins, Matadors and ever Pacers. Many Jeeps made in the 70s and 80s were equipped with the AMC V8s, also.



AMERICAN MOTORS 199-258 C.I. 4.0L 6 CYL. 1964-1998

APPLICATIONS/CAMSHAFTS	VALVE SETTING		RPM OPERATING RANGE	CAM PART #	CAM GRIND #	DURATION				VALVE LIFT		LOBE SEP. ANGLE
	IN.	EX.				ADVERTISED IN.	EX.	@ .050" IN.	EX.	W/ 1.6 ROCKER IN.	EX.	
HIGH ENERGY™ Hydraulic Flat Tappet Camshafts (NOT FOR FUEL INJECTION)												
HYDRAULIC – Our best cam for gas mileage. Strong low end torque. Good stock replacement with very smooth idle.	Hyd.	Hyd.	800 to 4000	68-115-4⁹⁷	240H	240	248	192	200	.416	.416	108°
HYDRAULIC – Excellent torque and throttle response. Good for towing. Smooth idle.	Hyd.	Hyd.	1000 to 4200	68-200-4⁹⁷	252H	252	252	206	206	.433	.433	110°
HYDRAULIC – Good power for Cherokees & Jeeps. Great for towing, 4WD and off-road. Smooth idle.	Hyd.	Hyd.	1200 to 4400	68-201-4⁹⁷	260H	260	260	212	212	.447	.447	110°
XTREME 4X4™ Hydraulic Flat Tappet Camshafts (NOT FOR FUEL INJECTION)												
HYDRAULIC – Excellent torque and throttle response, great stock replacement cam.	Hyd.	Hyd.	800 to 5000	68-231-4⁹⁷	X4250H	250	258	206	214	.462	.485	111°
HYDRAULIC - Good torque and excellent mid-range power. Best with lower gear ratios.	Hyd.	Hyd.	1000 to 5300	68-235-4⁹⁷	X4254H	254	262	210	218	.477	.493	111°
HYDRAULIC – Good mid to upper torque, needs increased compression, headers and gears.	Hyd.	Hyd.	1400 to 5700	68-239-4⁹⁷	X4262H	262	270	218	226	.493	.512	111°
XTREME 4X4™ Hydraulic Flat Tappet Camshafts (FOR FUEL INJECTION)												
HYDRAULIC – Excellent torque and throttle response, great upgrade for stock cam in fuel injected applications.	Hyd.	Hyd.	800 to 4800	68-232-4^{97,102}	X4250H-13	250	256	206	212	.460	.476	113°

AMERICAN MOTORS 290-401 C.I. 8 CYL. 1966-1991

APPLICATIONS/CAMSHAFTS	VALVE SETTING		RPM OPERATING RANGE	CAM PART #	CAM GRIND #	DURATION				VALVE LIFT		LOBE SEP. ANGLE
	IN.	EX.				ADVERTISED IN.	EX.	@ .050" IN.	EX.	W/ 1.6 ROCKER IN.	EX.	
HIGH ENERGY™ Hydraulic Flat Tappet Camshafts												
HYDRAULIC – Strong torque, excellent mileage for 290-304, has smooth idle, good for stock replacement.	Hyd.	Hyd.	800 to 4800	10-200-4	252H	252	252	206	206	.433	.433	110°
HYDRAULIC – Good low end torque. Strong mid-range power. Excellent for towing or performance. Smooth idle in 304 and up.	Hyd.	Hyd.	1200 to 5200	10-201-4	260H	260	260	212	212	.447	.447	110°
HYDRAULIC – Great for mild daily driven street machines. Slightly rough idle, broad powerband. Use lower gears in 290-304.	Hyd.	Hyd.	1500 to 5500	10-202-4	268H	268	268	218	218	.456	.456	110°
MAGNUM Hydraulic Flat Tappet Camshafts												
HYDRAULIC – Best cam for 360-401 with stock converter. Works well with headers and aftermarket intake. Mild rough idle.	Hyd.	Hyd.	1800 to 5800	10-203-4	270H	270	270	224	224	.480	.480	110°
HYDRAULIC – Great street machine cam. Needs manifold, 2500 converter and lower gears. 9:1 compression. Rough idle.	Hyd.	Hyd.	2000 to 6000	10-204-4	280H	280	280	230	230	.490	.490	110°
HYDRAULIC – Street/strip cam for 360 and up. Use 10:1 compression with 3000+ converter and low gears. Very rough idle.	Hyd.	Hyd.	2500 to 6500	10-210-4	292H	292	292	244	244	.518	.518	110°
HYDRAULIC – Excellent for Pro Street or mild bracket racing. 3500+ stall, 10.5:1 compression, 4.10 gear or lower. Radical idle.	Hyd.	Hyd.	3000 to 7000	10-211-4	305H	305	305	253	253	.541	.541	110°

¹ Requires screw-in studs & guide plates

² Requires machining on cylinder heads

⁴ Requires .150" longer pushrod

⁷ Stock springs cannot be used

³⁷ Adjustable valve train required

⁶⁰ 1989 & later use .312" diameter valve with bead type locks

AMERICAN MOTORS 199-258 C.I. 4.0L 6 CYL. 1964-1998

K-KIT	SK-KIT	CL-KIT	RP-KIT	LIFTERS	TIMING SET	ROCKER ARMS	PUSHRODS	VALVE SPRINGS	RETAINERS	VALVE LOCKS	VALVE SEALS
HIGH ENERGY™ Hydraulic Flat Tappet Camshafts (NOT FOR FUEL INJECTION)											
K68-115-4 ⁸⁰	SK68-115-4	CL68-115-4	N/A	822-12	3219	N/A	N/A	926-12 ⁹⁶	744-12	603-12 ⁶⁰	504-12
K68-200-4 ⁸⁰	SK68-200-4	CL68-200-4	N/A	822-12	3219	N/A	N/A	926-12 ⁹⁶	744-12	603-12 ⁶⁰	504-12
K68-201-4 ⁸⁰	SK68-201-4	CL68-201-4	N/A	822-12	3219	N/A	N/A	926-12 ⁹⁶	744-12	603-12 ⁶⁰	504-12
XTREME 4X4™ Hydraulic Flat Tappet Camshafts (NOT FOR FUEL INJECTION)											
K68-231-4 ⁸⁰	SK68-231-4 ⁷	CL68-231-4 ⁷	N/A	822-12	3219	N/A	N/A	926-12 ⁹⁶	744-12	603-12 ⁶⁰	504-12
K68-235-4 ⁸⁰	SK68-235-4 ⁷	CL68-235-4 ⁷	N/A	822-12	3219	N/A	N/A	926-12 ⁹⁶	744-12	603-12 ⁶⁰	504-12
K68-239-4 ⁸⁰	SK68-239-4 ⁷	CL68-239-4 ⁷	N/A	822-12	3219	N/A	N/A	926-12 ⁹⁶	744-12	603-12 ⁶⁰	504-12
XTREME 4X4™ Hydraulic Flat Tappet Camshafts (FOR FUEL INJECTION)											
K68-232-4 ⁸⁰	SK68-232-4 ⁷	CL68-232-4 ⁷	N/A	822-12	3219	N/A	N/A	926-12 ⁹⁶	744-12	603-12 ⁶⁰	504-12

AMERICAN MOTORS 290-401 C.I. 8 CYL. 1966-1991

K-KIT	SK-KIT	CL-KIT	RP-KIT	LIFTERS	TIMING SET	ROCKER ARMS	PUSHRODS	VALVE SPRINGS	RETAINERS	VALVE LOCKS	VALVE SEALS
HIGH ENERGY™ Hydraulic Flat Tappet Camshafts											
K10-200-4	SK10-200-4	CL10-200-4	RPM1410-16 ¹	822-16	3218	1442-16 ^{1,4}	7812-16	940-16	744-16	603-16	504-16
K10-201-4	SK10-201-4	CL10-201-4	RPM1410-16 ¹	822-16	3218	1442-16 ^{1,4}	7812-16	940-16	744-16	603-16	504-16
K10-202-4	SK10-202-4 ⁷	CL10-202-4 ⁷	RPM1410-16 ¹	822-16	3218	1442-16 ^{1,4}	7812-16	940-16	744-16	603-16	504-16
MAGNUM Hydraulic Flat Tappet Camshafts											
K10-203-4	SK10-203-4 ⁷	CL10-203-4 ⁷	RPM1410-16 ¹	822-16	3118	1442-16 ^{1,4}	7694-16	926-16	740-16	612-16	504-16
K10-204-4	SK10-204-4 ⁷	CL10-204-4 ⁷	RPM1410-16 ¹	822-16 867-16 ³⁷	3118	1442-16 ^{1,4}	7694-16	926-16	740-16	612-16	504-16
K10-210-4	SK10-210-4 ⁷	CL10-210-4 ⁷	RPM1410-16 ¹	822-16 867-16 ³⁷	3118	1442-16 ^{1,4}	7694-16	986-16 ²	740-16	612-16	505-16 ²
K10-211-4	SK10-211-4 ⁷	CL10-211-4 ⁷	RPM1410-16 ¹	822-16 867-16 ³⁷	3118	1442-16 ^{1,4}	7694-16	986-16 ²	740-16	612-16	505-16 ²

⁸⁰ K-Kits will only work in 1964-88 models due to different valve stem diameters

⁹⁶ Works in 1964-88 models only

⁹⁷ Must use timing set #3219 in 1999 & newer applications

¹⁰² Cam for 1999-2005 applications also available

RED NUMBERS DENOTE PREMIUM OPTION



AMERICAN MOTORS 290-401 C.I. 8 CYL. 1966-1991 (CONTINUED)

APPLICATIONS/CAMSHAFTS	VALVE SETTING		RPM OPERATING RANGE	CAM PART #	CAM GRIND #	DURATION				VALVE LIFT		LOBE SEP. ANGLE
	IN.	EX.				IN.	EX.	IN.	EX.	IN.	EX.	
XTREME ENERGY™ Hydraulic Flat Tappet Camshafts												
HYDRAULIC – Strong torque through low end and mid-range, good idle.	Hyd.	Hyd.	1200 to 5200	10-214-5	XE256H	256	268	212	218	.477	.484	110°
HYDRAULIC – Excellent response, good mid-range, noticeable idle.	Hyd.	Hyd.	1800 to 5800	10-215-5	XE262H	262	270	218	224	.493	.500	110°
HYDRAULIC – Very strong mid-range and throttle response, 2200+ stall. Rough idle.	Hyd.	Hyd.	2000 to 6000	10-216-5	XE274H	274	286	230	236	.520	.523	110°
THUMPR™ Hydraulic Flat Tappet Camshafts												
HYDRAULIC – Thumpr™ – High performance street, stock converter ok, best with 2000+ converter and gears. Choppy/thumping idle.	Hyd.	Hyd.	2000 to 5800	10-600-5	279TH7	279	296	227	241	.491	.476	107°
HYDRAULIC – Mutha' Thumpr™ – High performance street/strip, needs 9:1 compression, 2500+ stall, intake, gears and headers, rough idle.	Hyd.	Hyd.	2200 to 6100	10-603-5	287TH7	287	304	235	249	.500	.486	107°
HYDRAULIC – Big Mutha' Thumpr™ – Street/strip, needs 9.5:1 compression, 2800+ stall, intake, gears and headers, very rough idle.	Hyd.	Hyd.	2500 to 6400	10-604-5	295TH7	295	312	243	257	.512	.497	107°
APPLICATIONS/CAMSHAFTS	VALVE SETTING		RPM OPERATING RANGE	CAM PART #	CAM GRIND #	DURATION				VALVE LIFT		LOBE SEP. ANGLE
	IN.	EX.				IN.	EX.	IN.	EX.	IN.	EX.	
RACE Hydraulic Flat Tappet Camshafts												
HYDRAULIC – Best in heavy car with 3500+ stall and 10:1+ compression.	Hyd.	Hyd.	3500 to 7000	10-212-5	312H-8	312	312	260	260	.565	.565	108°
HYDRAULIC – Our best racing hydraulic, 4500+ stall or 4 speed with 11:1 compression.	Hyd.	Hyd.	4000 to 7500	10-213-5	320H-8	320	320	268	268	.565	.565	108°
APPLICATIONS/CAMSHAFTS	VALVE SETTING		RPM OPERATING RANGE	CAM PART #	CAM GRIND #	DURATION				VALVE LIFT		LOBE SEP. ANGLE
	IN.	EX.				IN.	EX.	IN.	EX.	IN.	EX.	
XTREME ENERGY™ Hydraulic Roller Camshafts												
HYDRAULIC ROLLER - Great 4x4 and offroad cam for off idle grunt and responsiveness. Mild but noticable idle.	Hyd.	Hyd.	1200-5200	10-801-11	XE264HR-10	264	270	212	218	.513	.513	110°
HYDRAULIC ROLLER - Excellent combination of mid-range and top end power and noticable idle.	Hyd.	Hyd.	1800-5800	10-802-11	XE276HR-10	276	282	224	230	.513	.513	110°
HYDRAULIC ROLLER - Street-strip grind for larger displacement engines w/ high compression, converter and gears.	Hyd.	Hyd.	2100-6100	10-803-11	XE291HR-10	291	297	236	242	.516	.534	110°
THUMPR™ Hydraulic Roller Camshafts												
HYDRAULIC ROLLER – Thumpr™ – High performance street, stock converter ok, best with 2000+ converter and gears. Choppy/thumping idle.	Hyd.	Hyd.	2000-5800	10-600-11	283THR7	283	303	227	241	.531	.515	107°
HYDRAULIC ROLLER – Mutha' Thumpr™ – High performance street/strip, needs 9:1 compression, 2500+ stall, intake, gears and headers, rough idle.	Hyd.	Hyd.	2200-6100	10-601-11	291THR7	291	311	235	249	.540	.526	107°
HYDRAULIC ROLLER – Big Mutha' Thumpr™ – Street/strip, needs 9.5:1 compression, 2800+ stall, intake, gears and headers, very rough idle.	Hyd.	Hyd.	2500-6400	10-602-11	299THR7	299	319	243	257	.552	.537	107°

1 Requires screw-in studs & guide plates
2 Requires machining on cylinder heads

4 Requires .150" longer pushrod
7 Stock springs cannot be used

37 Adjustable valve train required

AMERICAN MOTORS 290-401 C.I. 8 CYL. 1966-1991 (CONTINUED)

K-KIT	SK-KIT	CL-KIT	RP-KIT	LIFTERS	TIMING SET	ROCKER ARMS	PUSHRODS	VALVE SPRINGS	RETAINERS	VALVE LOCKS	VALVE SEALS
XTREME ENERGY™ Hydraulic Flat Tappet Camshafts											
K10-214-5	SK10-214-5	CL10-214-5	RPM1410-16 ¹	822-16	3118	1442-16 ^{1,4}	7694-16	926-16	740-16	612-16	504-16
K10-215-5	SK10-215-5 ⁷	CL10-215-5 ⁷	RPM1410-16 ¹	822-16	3118	1442-16 ^{1,4}	7694-16	926-16	740-16	612-16	504-16
K10-216-5	SK10-216-5 ⁷	CL10-216-5 ⁷	RPM1410-16 ¹	822-16 867-16 ³⁷	3118	1442-16 ^{1,4}	7694-16	986-16 ²	740-16	612-16	505-16 ²
THUMPR™ Hydraulic Flat Tappet Camshafts											
K10-600-5	N/A	CL10-600-5 ⁷	RPM1410-16 ¹	822-16 867-16 ³⁷	3118	1442-16 ^{1,4}	7694-16	986-16 ²	740-16	612-16	505-16 ²
K10-603-5	N/A	CL10-603-5 ⁷	RPM1410-16 ¹	822-16 867-16 ³⁷	3118	1442-16 ^{1,4}	7694-16	986-16 ²	740-16	612-16	505-16 ²
K10-604-5	N/A	CL10-604-5 ⁷	RPM1410-16 ¹	822-16 867-16 ³⁷	3118	1442-16 ^{1,4}	7694-16	986-16 ²	740-16	612-16	505-16 ²
LIFTERS	TIMING SET	ROCKER ARMS	PUSHRODS	VALVE SPRINGS	RET.	VALVE LOCKS	VALVE SEALS	LASH CAPS	REV KIT	DIST. GEAR	STUD GIRDLES
RACE Hydraulic Flat Tappet Camshafts											
867-16 ³⁷	3118	1442-16 ^{1,4}	7694-16	986-16 ²	740-16	612-16	505-16 ²	622-16	N/A	N/A	N/A
867-16 ³⁷	3118	1442-16 ^{1,4}	7694-16	986-16 ²	740-16	612-16	505-16 ²	622-16	N/A	N/A	N/A
K-KIT	SK-KIT	CL-KIT	RP-KIT	LIFTERS	TIMING SET	ROCKER ARMS	PUSHRODS	VALVE SPRINGS	RETAINERS	VALVE LOCKS	VALVE SEALS
XTREME ENERGY™ Hydraulic Roller Camshafts											
K10-801-11	SK10-801-11	CL10-801-11	N/A	8960-16	3118	1442-16 1631-16	7809-16 7609-16	985-16 26056-16	740-16 705-16	612-16	504-16
K10-802-11	SK10-802-11	CL10-802-11	N/A	8960-16	3118	1442-16 1631-16	7809-16 7609-16	985-16 26056-16	740-16 705-16	612-16	504-16
K10-803-11	SK10-803-11	CL10-803-11	N/A	8960-16	3118	1442-16 1631-16	7809-16 7609-16	985-16 26056-16	740-16 705-16	612-16	504-16
THUMPR™ Hydraulic Roller Camshafts											
K10-600-11	SK10-600-11	CL10-600-11	N/A	8960-16	3118	1442-16 1631-16	7809-16 7609-16	985-16 26056-16	740-16 705-16	612-16	504-16
K10-601-11	SK10-601-11	CL10-601-11	N/A	8960-16	3118	1442-16 1631-16	7809-16 7609-16	985-16 26056-16	740-16 705-16	612-16	504-16
K10-602-11	SK10-602-11	CL10-602-11	N/A	8960-16	3118	1442-16 1631-16	7809-16 7609-16	985-16 26056-16	740-16 705-16	612-16	504-16

RED NUMBERS DENOTE PREMIUM OPTION

AMERICAN MOTORS 290-401 C.I. 8 CYL. 1966-1991 (CONTINUED)

APPLICATIONS/CAMSHAFTS	VALVE SETTING		RPM OPERATING RANGE	CAM PART #	CAM GRIND #	DURATION				VALVE LIFT		LOBE SEP. ANGLE
	IN.	EX.				ADVERTISED IN.	EX.	@ .050" IN.	EX.	W/ 1.6 ROCKER IN.	EX.	
RACE Mechanical Flat Tappet Camshafts												
SOLID – Great for mid-range torque in a heavy car with a 4000 converter and 10.5:1 compression.	.026	.028	3800 to 6800	10-601-5	290B-6	290	304	255	266	.576	.570	106°
SOLID – Best in 360 or larger engine with a 5000 converter or a 4 speed and 11:1 compression.	.026	.028	4500 to 7500	10-602-5	300B-8	300	314	265	276	.600	.594	108°
SOLID – Bracket race and mud racing. Works best with 5000+ converter in 390 or larger engine.	.018	.020	5000 to 7500	10-610-5	304S-8	304	320	274	282	.629	.624	108°
RACE Mechanical Roller Camshafts												
MECHANICAL ROLLER – Bracket & super classes. Smooth profile, easy on parts, use w/ 390+ & 5500 converter.	.024	.026	5500 to 7500	10-800-11⁵	316AR-8	316	326	280	288	.672	.672	108°

CHRYSLER 2.2L, 2.5L SOHC 4 CYL. 1981-1987

APPLICATIONS/CAMSHAFTS	VALVE SETTING		RPM OPERATING RANGE	CAM PART #	CAM GRIND #	DURATION				VALVE LIFT		LOBE SEP. ANGLE
	IN.	EX.				ADVERTISED IN.	EX.	@ .050" IN.	EX.	IN.	EX.	
HIGH ENERGY™ Hydraulic SOHC Camshafts												
HYDRAULIC – Good torque and power. Good OEM replacement. Smooth idle.	Hyd.	Hyd.	1200 to 5000	22-123-6	260H	260	260	212	212	.460	.460	108°
HYDRAULIC – Great cam for everyday street driving. Broad powerband.	Hyd.	Hyd.	1500 to 5200	22-127-6	268H	268	268	224	224	.460	.460	108°
MAGNUM Hydraulic SOHC Camshafts												
HYDRAULIC – Best cam for performance usage. Slightly choppy idle.	Hyd.	Hyd.	1800 to 5500	22-131-6	280H	280	280	234	234	.460	.460	108°
TURBO Hydraulic SOHC Camshafts												
HYDRAULIC – For use in turbo engines w/ modifications.	Hyd.	Hyd.	3000 to 6000	22-124-6	260MT	260	260	218	218	.499	.499	112°

DODGE NEON SOHC 2.0L 4 CYL. 1995-2003

APPLICATIONS/CAMSHAFTS	VALVE SETTING		RPM OPERATING RANGE	CAM PART #	CAM GRIND #	DURATION				VALVE LIFT		LOBE SEP. ANGLE
	IN.	EX.				ADVERTISED IN.	EX.	@ .050" IN.	EX.	IN.	EX.	
HIGH ENERGY™ Hydraulic Roller Camshafts												
HYDRAULIC ROLLER – For use with stock Neon cylinder heads. More power throughout and substantial gains above 5000 RPM.	Hyd.	Hyd.	2500 to 6200	107-200-8	NE 256 HR8	256	266	200	206	.356	.336	108°
HYDRAULIC ROLLER – For use with Neon RT or ported cylinder heads. More power throughout and substantial gains above 5300 RPM.	Hyd.	Hyd.	2600 to 6400	107-400-8	NE 259 HR8	259	266	205	206	.384	.336	108°

CHRYSLER 170-225 C.I. 6 CYL. 1960-1987

APPLICATIONS/CAMSHAFTS	VALVE SETTING		RPM OPERATING RANGE	CAM PART #	CAM GRIND #	DURATION				VALVE LIFT		LOBE SEP. ANGLE
	IN.	EX.				ADVERTISED IN.	EX.	@ .050" IN.	EX.	W/ 1.5 ROCKER IN.	EX.	
HIGH ENERGY™ Hydraulic Flat Tappet Camshafts												
HYDRAULIC – Good stock replacement for mileage and power increase. Low RPM torque. Smooth idle.	Hyd.	Hyd.	800 to 4500	64-246-4	252H	252	252	206	206	.425	.425	110°
HYDRAULIC – Great power in mid-range RPM. Good choice for trucks and tow vehicles. Smooth idle.	Hyd.	Hyd.	1200 to 5000	64-247-4	260H	260	260	212	212	.440	.440	110°

⁵ Requires distributor gear upgrade

²² Fits 1981-87 models only

AMERICAN MOTORS 290-401 C.I. 8 CYL. 1966-1991 (CONTINUED)

LIFTERS	TIMING SET	ROCKER ARMS	PUSHRODS	VALVE SPRINGS	RET.	VALVE LOCKS	VALVE SEALS	LASH CAPS	REV KIT	DIST. GEAR	STUD GIRDLES	
RACE Mechanical Flat Tappet Camshafts												
801-16	3118	1442-16 ^{1,4}	7994-16	987-16 ² 950-16 ²	740-16 730-16	612-16	505-16 ²	622-16	N/A	N/A	N/A	
801-16	3118	1442-16 ^{1,4}	7994-16	987-16 ² 950-16 ²	740-16 730-16	612-16	505-16 ²	622-16	N/A	N/A	N/A	
801-16	3118	1442-16 ^{1,4}	7994-16	950-16 ²	730-16	612-16	505-16 ²	622-16	N/A	N/A	N/A	
RACE Mechanical Roller Camshafts												
861-16 ³⁷	3118	1832-16 ^{1,4}	7994-16	999-16 ² 944-16 ²	732-16 731-16	612-16	505-16 ²	622-16	N/A	N/A	N/A	

CHRYSLER 2.2L, 2.5L SOHC 4 CYL. 1981-1987

K-KIT	SK-KIT	CL-KIT	RP-KIT	LIFTERS	TIMING SET	ROCKER ARMS	PUSHRODS	VALVE SPRINGS	RETAINERS	VALVE LOCKS	VALVE SEALS
HIGH ENERGY™ Hydraulic SOHC Camshafts											
N/A	N/A	CL22-123-6	N/A	842-8	N/A	1222-8 ²²	N/A	N/A	N/A	N/A	N/A
N/A	N/A	CL22-127-6	N/A	842-8	N/A	1222-8 ²²	N/A	N/A	N/A	N/A	N/A
MAGNUM Hydraulic SOHC Camshafts											
N/A	N/A	CL22-131-6	N/A	842-8	N/A	1222-8 ²²	N/A	N/A	N/A	N/A	N/A
TURBO Hydraulic SOHC Camshafts											
N/A	N/A	CL22-124-6	N/A	842-8	N/A	1222-8 ²²	N/A	N/A	N/A	N/A	N/A

DODGE NEON SOHC 2.0L 4 CYL. 1995-2003

K-KIT	SK-KIT	CL-KIT	RP-KIT	LIFTERS	TIMING SET	ROCKER ARMS	PUSHRODS	VALVE SPRINGS	RETAINERS	VALVE LOCKS	VALVE SEALS
HIGH ENERGY™ Hydraulic Roller Camshafts											
N/A	N/A	N/A	N/A	N/A	N/A	N/A	N/A	N/A	N/A	N/A	N/A
N/A	N/A	N/A	N/A	N/A	N/A	N/A	N/A	N/A	N/A	N/A	N/A

CHRYSLER 170-225 C.I. 6 CYL. 1960-1987

K-KIT	SK-KIT	CL-KIT	RP-KIT	LIFTERS	TIMING SET	ROCKER ARMS	PUSHRODS	VALVE SPRINGS	RETAINERS	VALVE LOCKS	VALVE SEALS
HIGH ENERGY™ Hydraulic Flat Tappet Camshafts											
K64-246-4	SK64-246-4	CL64-246-4	N/A	820-12	3205	N/A	N/A	970-12	N/A	604-12	504-12
K64-247-4	SK64-247-4	CL64-247-4	N/A	820-12	3205	N/A	N/A	970-12	N/A	604-12	504-12

RED NUMBERS DENOTE PREMIUM OPTION



CHRYSLER 170-225 C.I. 6 CYL. 1960-1987 (CONTINUED)

APPLICATIONS/CAMSHAFTS	VALVE SETTING		RPM OPERATING RANGE	CAM PART #	CAM GRIND #	DURATION				VALVE LIFT		LOBE SEP. ANGLE
	IN.	EX.				IN.	EX.	IN.	EX.	IN.	EX.	
HIGH ENERGY™ Mechanical Flat Tappet Camshafts												
SOLID – Great power and mileage increases. Smooth idle.	.010	.012	800 to 4500	64-240-4	252S	252	252	215	215	.435	.435	110°
SOLID – Excellent choice for trucks and towing. Good power in low-mid RPM. Smooth idle.	.010	.012	1200 to 5000	64-241-4	264S	264	264	220	220	.440	.440	110°

CHRYSLER 273-360 C.I. 8 CYL. 1964-2003

APPLICATIONS/CAMSHAFTS	VALVE SETTING		RPM OPERATING RANGE	CAM PART #	CAM GRIND #	DURATION				VALVE LIFT		LOBE SEP. ANGLE
	IN.	EX.				IN.	EX.	IN.	EX.	IN.	EX.	
HIGH ENERGY™ Hydraulic Flat Tappet Camshafts												
HYDRAULIC – Smooth idle. Great replacement for 318 or 360 2 BBL or 4 BBL passenger car or truck. High vacuum and excellent low speed torque.	Hyd.	Hyd.	800 to 4800	20-208-2	252H	252	252	206	206	.425	.425	110°
HYDRAULIC – Great for 360 4 BBL in medium to heavy-duty applications. Great performance cam for 318 with power brakes and air.	Hyd.	Hyd.	1200 to 5200	20-210-2	260H	260	260	212	212	.440	.440	110°
HYDRAULIC – Replacement for HP 340 and 360 4 BBL motors. Noticeable idle in 318. Works with 3.23-3.55 gear, dual exhaust and 9:1 compression.	Hyd.	Hyd.	1500 to 5500	20-212-2	268H	268	268	218	218	.454	.454	110°
MAGNUM Hydraulic Flat Tappet Camshafts												
HYDRAULIC – Mild high performance in 340, 3.53-3.91 gears, dual exhaust and 9:1 compression.	Hyd.	Hyd.	1800 to 5800	20-214-4	270H	270	270	224	224	.470	.470	110°
HYDRAULIC – Use in 340-360 street machine. Dual exhaust, 3.53-3.91 gear, 9:1 compression. Headers and aftermarket intake, 2500 stall.	Hyd.	Hyd.	2500 to 6000	20-232-4	280H	280	280	230	230	.480	.480	110°
HYDRAULIC – Serious street/strip effort. 9.5:1 to 10.5:1 compression. Aftermarket manifold, headers and 3.91 gear. 3000-3500 stall in automatic cars.	Hyd.	Hyd.	3000 to 6500	20-243-4	292H	292	292	244	244	.501	.501	110°
HYDRAULIC – Pro Street/all out bracket racing. 3500 to 4000 stall, 10:1 to 11:1 compression. Aftermarket manifold with 750 CFM carb.	Hyd.	Hyd.	3500 to 6800	20-244-4	305H	305	305	253	253	.525	.525	110°
XTREME ENERGY™ Hydraulic Flat Tappet Camshafts												
HYDRAULIC – Very strong torque excellent mileage, smooth idle.	Hyd.	Hyd.	800 to 4800	20-220-3	XE250H	250	260	206	212	.432	.444	110°
HYDRAULIC – Strong torque through low end and mid-range, good idle.	Hyd.	Hyd.	1000 to 5200	20-221-3	XE256H	256	268	212	218	.447	.455	110°
HYDRAULIC – Excellent response, good mileage, stock converter, 3.23-4.10 gear.	Hyd.	Hyd.	1300 to 5600	20-222-3	XE262H	262	270	218	224	.462	.470	110°
HYDRAULIC – Great for street machines, largest cam for stock converter, 273-318 works best with 2000 stall.	Hyd.	Hyd.	1600 to 5800	20-223-3	XE268H	268	280	224	230	.477	.480	110°
HYDRAULIC – Very strong torque and throttle response, 2200+ stall.	Hyd.	Hyd.	1800 to 6000	20-224-4	XE274H	274	286	230	236	.488	.491	110°
HYDRAULIC – Street/strip, needs 3000+ stall, headers, gears, rough idle.	Hyd.	Hyd.	2300 to 6500	20-225-4	XE284H	284	296	240	246	.507	.510	110°
HYDRAULIC – Pro Street/bracket, good intake, headers, gear, 3500+ stall.	Hyd.	Hyd.	3000 to 7000	20-226-4	XE294H	294	306	250	256	.519	.524	110°

² Requires machining on cylinder heads

⁷ Stock springs cannot be used

²³ Includes special shafts & spacers

²⁴ Special 10° 4 groove lock. Single groove use Part #612-16.

³⁷ Adjustable valve train required

CHRYSLER 170-225 C.I. 6 CYL. 1960-1987

K-KIT	SK-KIT	CL-KIT	RP-KIT	LIFTERS	TIMING SET	ROCKER ARMS	PUSHRODS	VALVE SPRINGS	RETAINERS	VALVE LOCKS	VALVE SEALS
HIGH ENERGY™ Mechanical Flat Tappet Camshafts											
K64-240-4	SK64-240-4	CL64-240-4	N/A	821-12 801-12	3205	N/A	7864-12	970-12	N/A	604-12	504-12
K64-241-4	SK64-241-4	CL64-241-4	N/A	821-12 801-12	3205	N/A	7864-12	970-12	N/A	604-12	504-12

CHRYSLER 273-360 C.I. 8 CYL. 1964-2003

K-KIT	SK-KIT	CL-KIT	RP-KIT	LIFTERS	TIMING SET	ROCKER ARMS	PUSHRODS	VALVE SPRINGS	RETAINERS	VALVE LOCKS	VALVE SEALS
HIGH ENERGY™ Hydraulic Flat Tappet Camshafts											
K20-208-2	SK20-208-2	CL20-208-2	RP1622-16	822-16	3203 2103	1622-16 ²³	7958-16	901-16	744-16	604-16	504-16
K20-210-2	SK20-210-2	CL20-210-2	RP1622-16	822-16	3203 2103	1622-16 ²³	7958-16	901-16	744-16	604-16	504-16
K20-212-2	SK20-212-2 ⁷	CL20-212-2 ⁷	RP1622-16	822-16	3203 2103	1622-16 ²³	7958-16	901-16	744-16	604-16	504-16
MAGNUM Hydraulic Flat Tappet Camshafts											
K20-214-4	SK20-214-4 ⁷	CL20-214-4 ⁷	RP1622-16	822-16 867-16 ³⁷	3203 2103	1622-16 ²³	7958-16	901-16	747-16	626-16 ²⁴	504-16
K20-232-4	SK20-232-4 ⁷	CL20-232-4 ⁷	RP1622-16	822-16 867-16 ³⁷	3203 2103	1622-16 ²³ 1074-KIT ²³	7958-16	901-16	747-16	626-16 ²⁴	504-16
K20-243-4	SK20-243-4 ⁷	CL20-243-4 ⁷	RP1622-16	822-16 867-16 ³⁷	3203 2103	1622-16 ²³ 1074-KIT ²³	7958-16	995-16 ² 26995-16 ²	740-16 795-16	626-16 ²⁴	505-16 ²
K20-244-4	SK20-244-4 ⁷	CL20-244-4 ⁷	RP1622-16	822-16 867-16 ³⁷	3203 2103	1622-16 ²³ 1074-KIT ²³	7958-16	995-16 ² 26995-16 ²	740-16 795-16	626-16 ²⁴	505-16 ²
XTREME ENERGY™ Hydraulic Flat Tappet Camshafts											
K20-220-3	SK20-220-3	CL20-220-3	RP1622-16	822-16	3203 2103	1622-16 ²³	7958-16	901-16	744-16	604-16	504-16
K20-221-3	SK20-221-3 ⁷	CL20-221-3 ⁷	RP1622-16	822-16	3203 2103	1622-16 ²³	7958-16	901-16	744-16	604-16	504-16
K20-222-3	SK20-222-3 ⁷	CL20-222-3 ⁷	RP1622-16	822-16 867-16 ³⁷	3203 2103	1622-16 ²³	7958-16	901-16	744-16	604-16	504-16
K20-223-3	SK20-223-3 ⁷	CL20-223-3 ⁷	RP1622-16	822-16 867-16 ³⁷	3203 2103	1622-16 ²³	7958-16	901-16	744-16	604-16	504-16
K20-224-4	SK20-224-4 ⁷	CL20-224-4 ⁷	RP1622-16	822-16 867-16 ³⁷	3203 2103	1622-16 ²³ 1074-KIT ²³	7958-16	995-16 ² 26995-16 ²	740-16 795-16	626-16 ²⁴	505-16 ²
K20-225-4	SK20-225-4 ⁷	CL20-225-4 ⁷	RP1622-16	822-16 867-16 ³⁷	3203 2103	1622-16 ²³ 1074-KIT ²³	7958-16	995-16 ² 26995-16 ²	740-16 795-16	626-16 ²⁴	505-16 ²
K20-226-4	SK20-226-4 ⁷	CL20-226-4 ⁷	RP1622-16	822-16 867-16 ³⁷	3203 2103	1622-16 ²³ 1074-KIT ²³	7958-16	995-16 ² 26995-16 ²	740-16 795-16	626-16 ²⁴	505-16 ²

RED NUMBERS DENOTE PREMIUM OPTION



CHRYSLER 273-360 C.I. 8 CYL. 1964-2003 (CONTINUED)

APPLICATIONS/CAMSHAFTS	VALVE SETTING		RPM OPERATING RANGE	CAM PART #	CAM GRIND #	DURATION				VALVE LIFT		LOBE SEP. ANGLE
	IN.	EX.				IN.	EX.	IN.	EX.	IN.	EX.	
THUMPR™ Hydraulic Flat Tappet Camshafts												
HYDRAULIC – Thumpr™ – High performance street, stock converter ok, best with 2000+ converter and gears. Choppy/thumping idle.	Hyd.	Hyd.	2000 to 5800	20-600-4	279TH7	279	296	227	241	.486	.473	107°
HYDRAULIC – Mutha' Thumpr™ – High performance street/strip, needs 9:1 compression, 2500+ stall, intake, gears and headers, rough idle.	Hyd.	Hyd.	2200 to 6100	20-601-4	287TH7	287	304	235	249	.497	.483	107°
HYDRAULIC – Big Mutha' Thumpr™ – Street/strip, needs 9.5:1 compression, 2800+ stall, intake, gears and headers, very rough idle.	Hyd.	Hyd.	2500 to 6400	20-602-4	295TH7	295	312	243	257	.507	.494	107°
XTREME ENERGY™ HI-LIFT Hydraulic Flat Tappet Camshafts												
HYDRAULIC – Best all around performance cam. Extra lift to help engine breathe at higher RPM, 2500+ stall with 9:1 compression.	Hyd.	Hyd.	2000 to 6000	20-227-4	XE275HL	275	287	231	237	.525	.525	110°
HYDRAULIC – Serious street/strip cam. Strong mid-range and upper RPM power. Hi-lift design to take advantage of ported heads and single plane intake, 3000+ stall with 9.5:1 compression.	Hyd.	Hyd.	2500 to 6500	20-228-4	XE285HL	285	297	241	247	.545	.545	110°
HYDRAULIC – Max effort street/bracket race cam. Likes ported heads and single plane intake, 3500+ stall with 10:1 compression.	Hyd.	Hyd.	3000 to 6800	20-229-4	XE295HL	295	307	251	257	.564	.564	110°
DUAL ENERGY™ Hydraulic Flat Tappet Camshafts												
HYDRAULIC – Good torque and mileage. Good RV and towing cam. Works with stock exhaust.	Hyd.	Hyd.	1200 to 5500	20-416-3	255DEH	255	275	203	219	.422	.462	110°
HYDRAULIC – Very strong mid-range. Everyday performance for stock exhaust.	Hyd.	Hyd.	1600 to 5750	20-417-3	265DEH	265	276	211	227	.442	.462	110°
HYDRAULIC – High performance street. Superior high end. Works with stock converter. Choppy idle.	Hyd.	Hyd.	2000 to 6000	20-418-3	275DEH	275	284	219	235	.462	.482	110°
NOSTALGIA PLUS™/PURPLE PLUS Hydraulic Flat Tappet Camshafts												
HYDRAULIC – Best all around street/strip cam with the performance sound of the sixties and early seventies. 2500+ stall with 9.5:1 compression.	Hyd.	Hyd.	2200 to 6000	20-670-4 20-670-20⁹⁴	PP280H	280	287	233	240	.474	.474	110°
HYDRAULIC – Choppy idle for serious street and mild race applications. 3000+ stall with 10:1 compression.	Hyd.	Hyd.	2500 to 6400	20-671-4	PP284H	284	291	239	246	.484	.484	108°
HYDRAULIC – Strong mid-range with a radical idle. Best replacement for the factory street/bracket race cam, 3500+ converter with 10:1 compression.	Hyd.	Hyd.	3000 to 6600	20-672-4	PP292H	292	299	247	254	.508	.508	108°

² Requires machining on cylinder heads

⁷ Stock springs cannot be used

²³ Includes special shafts & spacers

²⁴ Special 10° 4 groove lock. Single groove use Part #612-16.

³⁷ Adjustable valve train required

⁹⁴ Nitrided version

CHRYSLER 273-360 C.I. 8 CYL. 1964-2003 (CONTINUED)

K-KIT	GK-KIT	CL-KIT	LIFTERS	TIMING SET	GEAR DRIVE	ROCKER ARMS	PUSHRODS	VALVE SPRINGS	RETAINERS	VALVE LOCKS	VALVE SEALS
THUMPR™ Hydraulic Flat Tappet Camshafts											
K20-600-4	N/A	CL20-600-4 ⁷	822-16 867-16 ³⁷	2103 3103	N/A	1622-16 ²³	7958-16	995-16 ² 26995-16 ²	740-16 795-16	626-16 ²⁴	505-16 ²
K20-601-4	N/A	CL20-601-4 ⁷	822-16 867-16 ³⁷	2103 3103	N/A	1622-16 ²³	7958-16	995-16 ² 26995-16 ²	740-16 795-16	626-16 ²⁴	505-16 ²
K20-602-4	N/A	CL20-602-4 ⁷	822-16 867-16 ³⁷	2103 3103	N/A	1622-16 ²³	7958-16	995-16 ² 26995-16 ²	740-16 795-16	626-16 ²⁴	505-16 ²
K-KIT	SK-KIT	CL-KIT	RP-KIT	LIFTERS	TIMING SET	ROCKER ARMS	PUSHRODS	VALVE SPRINGS	RETAINERS	VALVE LOCKS	VALVE SEALS
XTREME ENERGY™ HI-LIFT Hydraulic Flat Tappet Camshafts											
K20-227-4	N/A	CL20-227-4	RP1622-16	822-16 867-16 ³⁷	2103 3103	1622-16 ²³ 1074-KIT ²³	7958-16	995-16 ²	740-16	626-16 ²⁴	505-16 ²
K20-228-4	N/A	CL20-228-4	RP1622-16	822-16 867-16 ³⁷	2103 3103	1622-16 ²³ 1074-KIT ²³	7958-16	978-16 ²	740-16	626-16 ²⁴	505-16 ²
K20-229-4	N/A	CL20-229-4	RP1622-16	822-16 867-16 ³⁷	2103 3103	1622-16 ²³ 1074-KIT ²³	7958-16	978-16 ²	740-16	626-16 ²⁴	505-16 ²
DUAL ENERGY™ Hydraulic Flat Tappet Camshafts											
K20-416-3	SK20-416-3 ⁷	CL20-416-3 ⁷	RP1622-16	822-16 867-16 ³⁷	3203 2103	1622-16 ²³	7958-16	901-16	744-16	604-16	504-16
K20-417-3	SK20-417-3 ⁷	CL20-417-3 ⁷	RP1622-16	822-16 867-16 ³⁷	3203 2103	1622-16 ²³	7958-16	901-16	744-16	604-16	504-16
K20-418-3	SK20-418-3 ⁷	CL20-418-3 ⁷	RP1622-16	822-16 867-16 ³⁷	3203 2103	1622-16 ²³	7958-16	901-16	744-16	604-16	504-16
NOSTALGIA PLUS™/PURPLE PLUS Hydraulic Flat Tappet Camshafts											
K20-670-4	N/A	CL20-670-4	RP1622-16	822-16 867-16 ³⁷	2103 3103	1622-16 ²³	7958-16	995-16 ² 26995-16 ²	740-16 795-16	626-16 ²⁴	505-16 ²
K20-671-4	N/A	CL20-671-4	RP1622-16	822-16 867-16 ³⁷	2103 3103	1622-16 ²³	7958-16	995-16 ² 26995-16 ²	740-16 795-16	626-16 ²⁴	505-16 ²
K20-672-4	N/A	CL20-672-4 ⁷	RP1622-16	822-16 867-16 ³⁷	2103 3103	1622-16 ²³	7958-16	995-16 ² 26995-16 ²	740-16 795-16	626-16 ²⁴	505-16 ²

CHRYSLER 273-360 C.I. 8 CYL. 1964-2003 (CONTINUED)

APPLICATIONS/CAMSHAFTS	VALVE SETTING		RPM OPERATING RANGE	CAM PART #	CAM GRIND #	DURATION				VALVE LIFT		LOBE SEP. ANGLE
	IN.	EX.				ADVERTISED IN.	EX.	@ .050" IN.	EX.	W/ 1.5 ROCKER IN.	EX.	
MAGNUM MUSCLE Hydraulic Flat Tappet Camshafts (Today's Version Of Yesterday's Muscle Car Cams)												
HYDRAULIC – Factory I.D. #2899206 for: 340c.i., 1968-71, factory 275 HP 340c.i., 1970, factory 290 HP 340c.i., 1972-73, factory 240 HP	Hyd.	Hyd.	1800 to 5800	20-309-4⁷	268AH-10	268	276	222	226	.464	.464	110°
DRAG RACE Hydraulic Flat Tappet Camshafts												
HYDRAULIC – Needs 4000+ stall. Headers, manifold. 750 CFM.	Hyd.	Hyd.	3500 to 6500	20-244-4⁷	305H	305	305	253	253	.525	.525	110°
XTREME ENERGY™ Retro-Fit Hydraulic Roller Camshafts												
HYDRAULIC ROLLER – 3.23-3.91 gears, stock converter in 340 and 360, mild converter in 318, 9:1 compression, street machine.	Hyd.	Hyd.	1400 to 5500	20-810-9	XR268HR-10	268	276	218	224	.535	.531	110°
HYDRAULIC ROLLER – 3.55-4.10 gears, 2200+ stall, 9:1 compression, headers, high performance street.	Hyd.	Hyd.	1800 to 5800	20-811-9	XR274HR-10	274	282	224	230	.538	.534	110°
HYDRAULIC ROLLER – 3.91+ gears, 9.5:1 compression, 2500+ stall, aftermarket intake, headers.	Hyd.	Hyd.	2200 to 6000	20-812-9	XR280HR-10	280	288	230	236	.541	.537	110°
HYDRAULIC ROLLER – 3.91+ gears, 2800+ stall, 9.5:1 compression, needs headers, rough idle, street strip.	Hyd.	Hyd.	2500 to 6200	20-813-9	XR286HR-10	286	294	236	242	.544	.541	110°
HYDRAULIC ROLLER – 4.10 gear, 3000+ stall, 10:1 compression, Pro Street applications, very rough idle.	Hyd.	Hyd.	2800 to 6400	20-814-9	XR292HR-10	292	300	242	248	.549	.544	110°
THUMPR™ Retro-Fit Hydraulic Roller Camshafts												
HYDRAULIC ROLLER – Thumpr™ – High performance street, stock converter ok, best with 2000+ converter and gears, choppy/thumping idle.	Hyd.	Hyd.	1900 to 5600	20-600-9	283THR7	283	303	227	241	.513	.498	107°
HYDRAULIC ROLLER – Mutha' Thumpr™ – High performance street/strip, needs 9:1 compression, 2500+ stall, intake, gears and headers, rough idle.	Hyd.	Hyd.	2200 to 5900	20-601-9	291THR7	291	311	235	249	.522	.509	107°
HYDRAULIC ROLLER – Big Mutha' Thumpr™ – Street/strip, needs 9.5:1 compression, 2800+ stall, intake, gears and headers, very rough idle.	Hyd.	Hyd.	2500 to 6200	20-603-9	299THR7	299	319	243	257	.533	.519	107°
COMPUTER CONTROLLED Hydraulic Roller Camshafts												
1985-92 w/ Shaft Rockers & Mech. Fuel Pump, Long Snout												
HYDRAULIC ROLLER – Best in a 318 engine. Good towing cam for Dakota P/U. This cam has oil holes and a long snout.	Hyd.	Hyd.	700 to 4800	20-618-9⁷	254HR-12	254	262	199	206	.450	.450	112°
HYDRAULIC ROLLER – Best in a 360 engine. Good towing cam for full size P/U. Good performance cam for Dakota. This cam has oil holes and a long snout, may require computer modifications.	Hyd.	Hyd.	800 to 5000	20-612-9⁷	262HR-12	262	264	206	210	.450	.480	112°
HYDRAULIC ROLLER – Best performance cam for 360 engine. This cam has oil holes and a long snout, will require computer modifications.	Hyd.	Hyd.	900 to 5200	20-614-9⁷	264HR-12	264	274	210	220	.480	.480	112°

² Requires machining on cylinder heads

⁷ Stock springs cannot be used

²³ Includes special shafts & spacers

CHRYSLER 273-360 C.I. 8 CYL. 1964-2003 (CONTINUED)

LIFTERS	TIMING SET	ROCKER ARMS	PUSHRODS	VALVE SPRINGS	RETAINERS	VALVE LOCKS	VALVE SEALS	LASH CAPS	REV KIT	DIST. GEAR	STUD GIRDLES
MAGNUM MUSCLE Hydraulic Flat Tappet Camshafts (Today's Version Of Yesterday's Muscle Car Cams)											
822-16	2103	1622-16 ²³ 1074-KIT ²³	7958-16	901-16	740-16	604-16	504-16	622-16	N/A	N/A	N/A
DRAG RACE Hydraulic Flat Tappet Camshafts											
822-16 867-16 ³⁷	3103	1622-16 ²³ 1074-KIT ²³	7958-16	995-16 ² 978-16 ²	740-16 730-16	626-16 ²⁴	505-16 ²	622-16	N/A	N/A	N/A
XTREME ENERGY™ Retro-Fit Hydraulic Roller Camshafts											
8920-16	2103 3103	1622-16 ²³ 1074-KIT ²³	N/A	987-16 ² 26986-16 ²	740-16 795-16	626-16 ²⁴	505-16 ²	622-16	N/A	420	N/A
8920-16	2103 3103	1622-16 ²³ 1074-KIT ²³	N/A	987-16 ² 26986-16 ²	740-16 795-16	626-16 ²⁴	505-16 ²	622-16	N/A	420	N/A
8920-16	2103 3103	1622-16 ²³ 1074-KIT ²³	N/A	987-16 ² 26986-16 ²	740-16 795-16	626-16 ²⁴	505-16 ²	622-16	N/A	420	N/A
8920-16	2103 3103	1622-16 ²³ 1074-KIT ²³	N/A	987-16 ² 26986-16 ²	740-16 795-16	626-16 ²⁴	505-16 ²	622-16	N/A	420	N/A
8920-16	2103 3103	1622-16 ²³ 1074-KIT ²³	N/A	987-16 ² 26986-16 ²	740-16 795-16	626-16 ²⁴	505-16 ²	622-16	N/A	420	N/A
K-KIT	GK-KIT	CL-KIT	LIFTERS	TIMING SET	GEAR DRIVE	ROCKER ARMS	PUSHRODS	VALVE SPRINGS	RETAINERS	VALVE LOCKS	VALVE SEALS
THUMPR™ Retro-Fit Hydraulic Roller Camshafts											
K20-600-9	N/A	CL20-600-9 ⁷	8920-16	2103 3103	N/A	1622-16 ²³ 1074-KIT ²³	N/A	995-16 ² 26995-16 ²	740-16 795-16	626-16	505-16 ²
K20-601-9	N/A	CL20-601-9 ⁷	8920-16	2103 3103	N/A	1622-16 ²³ 1074-KIT ²³	N/A	995-16 ² 26995-16 ²	740-16 795-16	626-16	505-16 ²
K20-603-9	N/A	CL20-603-9 ⁷	8920-16	2103 3103	N/A	1622-16 ²³ 1074-KIT ²³	N/A	995-16 ² 26995-16 ²	740-16 795-16	626-16	505-16 ²
K-KIT	SK-KIT	CL-KIT	RP-KIT	LIFTERS	TIMING SET	ROCKER ARMS	PUSHRODS	VALVE SPRINGS	RETAINERS	VALVE LOCKS	VALVE SEALS
COMPUTER CONTROLLED Hydraulic Roller Camshafts											
N/A	N/A	N/A	N/A	N/A	3203 2103	1622-16 ²³	7937-16	901-16	747-16	626-16 ²⁴	504-16
N/A	N/A	N/A	N/A	N/A	3203 2103	1622-16 ²³	7937-16	901-16	747-16	626-16 ²⁴	504-16
N/A	N/A	N/A	N/A	N/A	3203 2103	1622-16 ²³	7937-16	901-16	747-16	626-16 ²⁴	504-16

²⁴ Special 10° 4 groove lock. Single groove use Part #612-16.

³⁷ Adjustable valve train required

CHRYSLER 273-360 C.I. 8 CYL. 1964-2003 (CONTINUED)

APPLICATIONS/CAMSHAFTS	VALVE SETTING		RPM OPERATING RANGE	CAM PART #	CAM GRIND #	DURATION				VALVE LIFT		LOBE SEP. ANGLE
	IN.	EX.				IN.	EX.	@ .050"	W/ 1.5 ROCKER	IN.	EX.	
COMPUTER CONTROLLED Hydraulic Roller Camshafts												
1988-91 w/ Shaft Rockers & Electric Fuel Pump, Short Snout												
HYDRAULIC ROLLER – Factory replacement for fuel injected engines with shaft mounted rocker arms. Good torque cam in 318.	Hyd.	Hyd.	700 to 4800	20-628-9⁷	254HR-12	254	262	199	206	.450	.450	112°
HYDRAULIC ROLLER – Performance cam for 318. Good towing cam for 360. May require computer modifications.	Hyd.	Hyd.	800 to 5000	20-622-9⁷	262HR-12	262	264	206	210	.450	.480	112°
HYDRAULIC ROLLER – High performance cam for 360. Will require computer modifications.	Hyd.	Hyd.	900 to 5200	20-624-9⁷	264HR-12	264	274	210	220	.480	.480	112°
XTREME ENERGY™ Computer Controlled Hydraulic Roller Camshafts For 1992-02 Magnum Engines (1.6 ROCKERS)												
1992-02 w/ Stud Mount Rockers & Electric Fuel Pump, Short Snout												
HYDRAULIC ROLLER – Super strong torque cam for 318, idle to 4500 RPM.	Hyd.	Hyd.	700 to 4800	20-744-9⁷	XR258HR-12	258	264	206	212	.480	.480	112°
HYDRAULIC ROLLER – Strong towing cam for 360, performance cam for 318 with better exhaust and computer modifications.	Hyd.	Hyd.	1000 to 5000	20-745-9⁷	XR264HR-14	264	270	212	218	.480	.480	114°
HYDRAULIC ROLLER – Performance cam for 360. Likes lower gears and exhaust. Will require computer modifications.	Hyd.	Hyd.	1200 to 5400	20-746-9⁷	XR265HR-14	265	273	216	224	.506	.506	114°
COMPUTER CONTROLLED Hydraulic Roller Camshafts For 1992-02 Magnum Engines (1.6 ROCKERS)												
HYDRAULIC ROLLER – Factory replacement for 318 with strong torque.	Hyd.	Hyd.	700 to 4800	20-608-9⁷	254HR-12	254	262	199	206	.480	.480	112°
HYDRAULIC ROLLER – Performance street cam for 318. Excellent torque in 360. May require computer modifications.	Hyd.	Hyd.	800 to 5000	20-602-9⁷	262HR-12	262	264	206	210	.480	.512	112°
HYDRAULIC ROLLER – High performance cam for 360. Will require computer modifications.	Hyd.	Hyd.	900 to 5200	20-604-9⁷	264HR-12	264	274	210	220	.512	.512	112°
MAGNUM Mechanical Flat Tappet Camshafts												
SOLID – Great in 340 and 360 with 9:1-9.5:1 compression, 650-750 CFM carb and 3.55-3.91 gear. Largest cam to use with stock converter.	.022	.022	1800 to 5800	20-246-4	270S	270	270	224	224	.468	.468	110°
SOLID – 340-360 street machine/bracket race with 2500 stall, 9.5:1-10.5:1 compression and 3.91-4.10 gear. Aftermarket manifold & 650-750 CFM carb.	.022	.022	2500 to 6000	20-247-4	282S	282	282	236	236	.495	.495	110°
SOLID – Excellent for Pro Street, bracket race 9.5:1 compression, 3000-3500 stall, 4.10-4.30 gear, aftermarket intake.	.022	.022	3000 to 6500	20-248-4	294S	294	294	248	248	.525	.525	110°
SOLID – Max effort bracket racing or Pro Street. 10:1-11:1 compression with 4000-4500 stall and 4.30-4.88 gear.	.022	.022	4000 to 7000	20-249-4	306S	306	306	260	260	.555	.555	110°
XTREME ENERGY™ Mechanical Flat Tappet Camshafts												
SOLID – 340-360 street/strip use. 9:1 compression with 2500 stall, strong mid-range.	.016	.018	2000 to 6000	20-233-4	XS268S	268	274	230	236	.488	.501	110°
SOLID – Great for street machines and mild bracket racing, 9.5:1 compression with 2800 stall, lopey idle.	.016	.018	2200 to 6200	20-230-4	XS274S	274	280	236	242	.502	.511	110°
SOLID – Serious street/strip effort, needs 10:1 compression, single plane intake and 3000 stall. Radical idle.	.016	.018	2500 to 6500	20-231-4	XS282S	282	290	244	252	.520	.540	110°

² Requires machining on cylinder heads

⁷ Stock springs cannot be used

²³ Includes special shafts & spacers

CHRYSLER 273-360 C.I. 8 CYL. 1964-2003 (CONTINUED)

K-KIT	SK-KIT	CL-KIT	RP-KIT	LIFTERS	TIMING SET	ROCKER ARMS	PUSHRODS	VALVE SPRINGS	RETAINERS	VALVE LOCKS	VALVE SEALS	
COMPUTER CONTROLLED Hydraulic Roller Camshafts												
N/A	N/A	N/A	N/A	N/A	3203 2103	1622-16 ²³	7937-16	901-16	747-16	626-16 ²⁴	504-16	
N/A	N/A	N/A	N/A	N/A	3203 2103	1622-16 ²³	7937-16	901-16	747-16	626-16 ²⁴	504-16	
N/A	N/A	N/A	N/A	N/A	3203 2103	1622-16 ²³	7937-16	901-16	747-16	626-16 ²⁴	504-16	
XTREME ENERGY™ Computer Controlled Hydraulic Roller Camshafts For 1992-02 Magnum Engines (1.6 ROCKERS)												
N/A	N/A	N/A	1425-KIT	N/A	3203 2103	N/A	7632-16	N/A	N/A	N/A	N/A	
N/A	N/A	N/A	1425-KIT	N/A	3203 2103	N/A	7632-16	N/A	N/A	N/A	N/A	
N/A	N/A	N/A	1425-KIT	N/A	3203 2103	N/A	7632-16	N/A	N/A	N/A	N/A	
COMPUTER CONTROLLED Hydraulic Roller Camshafts For 1992-02 Magnum Engines (1.6 ROCKERS)												
N/A	N/A	N/A	1425-KIT	N/A	3203 2103	N/A	7632-16	N/A	N/A	N/A	N/A	
N/A	N/A	N/A	1425-KIT	N/A	3203 2103	N/A	7632-16	N/A	N/A	N/A	N/A	
N/A	N/A	N/A	1425-KIT	N/A	3203 2103	N/A	7632-16	N/A	N/A	N/A	N/A	
MAGNUM Mechanical Flat Tappet Camshafts												
K20-246-4	SK20-246-4 ⁷	CL20-246-4 ⁷	RP1623-16	821-16	2103 3103	1622-16 ²³	7970-16	901-16 995-16 ²	740-16 795-16	626-16 ²⁴	504-16 505-16 ²	
K20-247-4	SK20-247-4 ⁷	CL20-247-4 ⁷	RP1623-16	821-16	2103 3103	1622-16 ²³	7970-16	995-16 ² 26995-16 ²	740-16 795-16	626-16 ²⁴	505-16 ²	
K20-248-4	SK20-248-4 ⁷	CL20-248-4 ⁷	RP1623-16	821-16	2103 3103	1622-16 ²³ 1074-KIT ²³	7970-16	995-16 ² 26995-16 ²	740-16 795-16	626-16 ²⁴	505-16 ²	
K20-249-4	SK20-249-4 ⁷	CL20-249-4 ⁷	RP1623-16	821-16	2103 3103	1622-16 ²³ 1074-KIT ²³	7970-16	995-16 ² 26995-16 ²	740-16 795-16	626-16 ²⁴	505-16 ²	
XTREME ENERGY™ Mechanical Flat Tappet Camshafts												
K20-233-4	N/A	CL20-233-4	RP1623-16	821-16	2103 3103	1622-16 ²³ 1074-KIT ²³	7970-16	986-16 ² 26986-16 ²	740-16 795-16	626-16 ²⁴	505-16 ²	
K20-230-4	N/A	CL20-230-4	RP1623-16	821-16	2103 3103	1622-16 ²³ 1074-KIT ²³	7970-16	986-16 ² 26986-16 ²	740-16 795-16	626-16 ²⁴	505-16 ²	
K20-231-4	N/A	CL20-231-4 ⁷	RP1623-16	821-16	2103 3103	1622-16 ²³ 1074-KIT ²³	7970-16	986-16 ² 26986-16 ²	740-16 795-16	626-16 ²⁴	505-16 ²	

²⁴ Special 10° 4 groove lock. Single groove use Part #612-16.

RED NUMBERS DENOTE PREMIUM OPTION

CHRYSLER 273-360 C.I. 8 CYL. 1964-2003 (CONTINUED)

APPLICATIONS/CAMSHAFTS	VALVE SETTING		RPM OPERATING RANGE	CAM PART #	CAM GRIND #	DURATION				VALVE LIFT		LOBE SEP. ANGLE
	IN.	EX.				IN.	EX.	IN.	EX.	IN.	EX.	
DRAG RACE Mechanical Flat Tappet Camshafts												
SOLID – 3500+ converter in 360 or 3800+ in 340. Needs single plane intake and 10.5:1 compression. Excellent low end and mid-range torque.	.020	.022	3500 to 6500	20-635-5	XTQ281S-6	281	299	252	262	.542	.555	106°
SOLID – 318-340. 4000+ stall, 750 CFM, manifold. 4.88 gear. 10.5:1+ compression.	.026	.028	4000 to 7000	20-618-5	290A-6	290	290	255	255	.540	.540	106°
SOLID – Best all around bracket cam. 4000+ converter in 360 or 4300+ stall in 340, min. compression ratio is 11:1.	.020	.022	4000 to 7000	20-633-5	XTQ290S-6	290	304	260	266	.558	.555	106°
SOLID – 4500 converter in 360 or 4800+ stall in 340, 11.5:1 compression.	.018	.020	4300 to 7400	20-634-5	TL295S-6	295	312	266	274	.570	.572	106°
SOLID – Good Super Street or fast bracket cam. Works best w/ 12:1 compression & 5000+ converter.	.018	.020	4500 to 7500	20-632-5	TL300S-8	300	316	270	278	.579	.578	108°
OVAL TRACK Mechanical Flat Tappet Camshafts												
SOLID – Good for short tracks. 1/4, 3/8 track w/ tight corners. Best with rules limiting intake & carb.	.018	.020	3500 to 6500	20-616-5	FL272B-6	272	280	242	250	.540	.556	106°
SOLID – Good short track cam for 340 or 360. Will turn more RPM in 340. Needs 10:1 compression & 4 BBL carb.	.020	.022	3500 to 6500	20-635-5	XTQ281S-6	281	299	252	262	.542	.555	106°
SOLID – Strong mid-range and upper RPM power needs 11:1 compression with open carb and intake.	.020	.022	4000 to 7000	20-633-5	XTQ290S-6	290	304	260	266	.558	.555	106°
SOLID – Good for medium sized tracks with sustained RPM.	.018	.020	4300 to 7400	20-634-5	TL295S-6	295	312	266	274	.570	.572	106°
SOLID – Very aggressive late model stock cam for long rod engine.	.018	.020	3500 to 6500	20-629-5	269MM-8	269	273	243	247	.549	.560	108°
SOLID – Very aggressive late model stock cam for shorter rod or larger track.	.018	.020	3700 to 6700	20-630-5	273MM-8	273	277	247	251	.560	.570	108°
SOLID – Very aggressive late model stock cam for shorter rod and larger track.	.018	.020	4000 to 7000	20-631-5	277MM-8	277	281	251	255	.570	.582	108°
MAGNUM Mechanical Roller Camshafts												
MECHANICAL ROLLER – Excellent for street/strip effort for 9.5:1 to 10:1 compression in 340 and 360. 3500 Stall, aftermarket intake with 750+ CFM carb.	.020	.020	3000 to 6500	20-701-9⁵	288R	288	288	243	243	.550	.550	110°
MECHANICAL ROLLER – Max effort street roller. 10:1+ compression with 750 CFM carb on aftermarket intake. 4.30-4.88 gear suggested with 4000-4500+ converter. Headers.	.020	.020	4000 to 7200	20-702-9⁵	308R	308	308	262	262	.575	.575	110°

² Requires machining on cylinder heads

⁵ Requires distributor gear upgrade

⁷ Stock springs cannot be used

¹³ Requires machining on block

²³ Includes special shafts & spacers

²⁴ Special 10° 4 groove lock. Single groove use Part #612-16.

CHRYSLER 273-360 C.I. 8 CYL. 1964-2003 (CONTINUED)

CAMSHAFTS CHRYSLER

LIFTERS	TIMING SET	ROCKER ARMS	PUSHRODS	VALVE SPRINGS	RETAINERS	VALVE LOCKS	VALVE SEALS	LASH CAPS	REV KIT	DIST. GEAR	STUD GIRDLES	
DRAG RACE Mechanical Flat Tappet Camshafts												
821-16 801-16 ⁷⁶	3103	1622-16 ²³ 1074-KIT ²³	7970-16	928-16 ²	1732-16 732-16	626-16 ²⁴	505-16 ²	622-16	N/A	420	N/A	
821-16 801-16 ⁷⁶	3103	1622-16 ²³ 1074-KIT ²³	7970-16	928-16 ²	732-16 721-16	626-16 ²⁴	505-16 ²	622-16	N/A	420	N/A	
821-16 801-16 ⁷⁶	3103	1622-16 ²³ 1074-KIT ²³	7970-16	928-16 ²	732-16 721-16	626-16 ²⁴	505-16 ²	622-16	N/A	420	N/A	
821-16 801-16 ⁷⁶	3103	1622-16 ²³ 1074-KIT ²³	7970-16	928-16 ²	732-16 721-16	626-16 ²⁴	505-16 ²	622-16	N/A	420	N/A	
821-16 801-16 ⁷⁶	3103	1622-16 ²³ 1074-KIT ²³	7970-16	928-16 ²	732-16 721-16	626-16 ²⁴	505-16 ²	622-16	N/A	420	N/A	
OVAL TRACK Mechanical Flat Tappet Camshafts												
821-16 801-16 ⁷⁶	3103	1622-16 ²³	7970-16	928-16 ²	732-16 721-16	626-16 ²⁴	505-16 ²	622-16	N/A	420	N/A	
821-16 801-16 ⁷⁶	3103	1622-16 ²³	7970-16	928-16 ²	732-16 721-16	626-16 ²⁴	505-16 ²	622-16	N/A	420	N/A	
821-16 801-16 ⁷⁶	3103	1622-16 ²³	7970-16	928-16 ²	732-16 721-16	626-16 ²⁴	505-16 ²	622-16	N/A	420	N/A	
821-16 801-16 ⁷⁶	3103	1622-16 ²³	7970-16	928-16 ²	732-16 721-16	626-16 ²⁴	505-16 ²	622-16	N/A	420	N/A	
821-16 801-16 ⁷⁶	3103	1622-16 ²³	7970-16	26094-16 ²	732-16 721-16	626-16 ²⁴	505-16 ²	622-16	N/A	420	N/A	
821-16 801-16 ⁷⁶	3103	1622-16 ²³	7970-16	26094-16 ²	732-16 721-16	626-16 ²⁴	505-16 ²	622-16	N/A	420	N/A	
821-16 801-16 ⁷⁶	3103	1622-16 ²³	7970-16	26094-16 ²	732-16 721-16	626-16 ²⁴	505-16 ²	622-16	N/A	420	N/A	
MAGNUM Mechanical Roller Camshafts												
K20-701-9 ⁵	SK20-701-9 ^{5,7}	CL20-701-9 ^{5,7}	RP1623-16	828-16 ¹³	2103 3103	1622-16 ²³	7970-16	914-16 ²	748-16 1732-16	626-16 ²⁴	505-16 ²	
K20-702-9 ⁵	SK20-702-9 ^{5,7}	CL20-702-9 ^{5,7}	RP1623-16	828-16 ¹³	2103 3103	1622-16 ²³	7970-16	914-16 ²	748-16 1732-16	626-16 ²⁴	505-16 ²	

⁷⁶ Oils through pushrods

CHRYSLER 273-360 C.I. 8 CYL. 1964-2003 (CONTINUED)

APPLICATIONS/CAMSHAFTS	VALVE SETTING		RPM OPERATING RANGE	CAM PART #	CAM GRIND #	DURATION				VALVE LIFT		LOBE SEP. ANGLE
	IN.	EX.				IN.	EX.	IN.	EX.	IN.	EX.	
XTREME ENERGY™ Mechanical Roller Camshafts												
MECHANICAL ROLLER – Good for mild street/strip use w/ 9:1 compression & 2500 stall. Noticeable idle.	.016	.018	2000 to 6000	20-743-9⁵	XR268R	268	274	230	236	.552	.564	110°
MECHANICAL ROLLER – Serious street/strip use. 9.5:1 compression with 2800+ stall. Lopey idle.	.016	.018	2200 to 6300	20-742-9⁵	XR274R	274	280	236	242	.564	.570	110°
MECHANICAL ROLLER – 3000 stall with 10:1 compression, strong mid-range with a radical idle.	.016	.018	2500 to 6500	20-741-9⁵	XR280R	280	286	242	248	.570	.576	110°
MECHANICAL ROLLER – 3300+ stall with 10:1 compression. Strong top end with a racey idle.	.016	.018	2800 to 6800	20-740-9⁵	XR286R	286	292	248	254	.576	.582	110°

APPLICATIONS/CAMSHAFTS	VALVE SETTING		RPM OPERATING RANGE	CAM PART #	CAM GRIND #	DURATION				VALVE LIFT		LOBE SEP. ANGLE
	IN.	EX.				IN.	EX.	IN.	EX.	IN.	EX.	
DRAG RACE Mechanical Roller Camshafts												
MECHANICAL ROLLER – Good all around bracket cam. 4200+ stall in 360 or 4500+ stall in 340, 11.5:1 compression.	.020	.022	4200 to 7400	20-719-9⁵	RX296S-R6	296	303	263	270	.649	.651	106°
MECHANICAL ROLLER – Good Super Street or bracket cam. 11.5:1 compression with 4500+ stall.	.020	.022	4500 to 7500	20-718-9⁵	RX302S-R6	302	309	269	276	.654	.655	106°
MECHANICAL ROLLER – Good Super Gas or Fast Bracket cam. 12:1 compression with 5500+ stall.	.026	.028	4800 to 7800	20-717-9⁵	RX308R-8	308	317	275	284	.658	.661	108°
MECHANICAL ROLLER – Good Super Gas, Super Comp or Fast Bracket cam, medium to large cubic inch engines with 6000+ converter.	.026	.028	5500 to 8000	20-716-9⁵	314R-10	314	321	281	288	.661	.664	110°
MECHANICAL ROLLER – Fast bracket, high compression.	.026	.028	5000 to 8000	20-721-9⁵	307-R6	307	310	274	279	.693	.645	106°
OVAL TRACK RACE Mechanical Roller Camshafts												
MECHANICAL ROLLER – Standard cam for late model with 360, strong mid-range.	.020	.022	4200 to 7400	20-719-9⁵	RX296S-R6	296	303	263	270	.649	.651	106°
MECHANICAL ROLLER – Good for medium to large tracks with sustained RPM.	.020	.022	4500 to 7500	20-718-9⁵	RX302S-R6	302	309	269	276	.654	.655	106°

² Requires machining on cylinder heads

⁵ Requires distributor gear upgrade

⁷ Stock springs cannot be used

¹³ Requires machining on block

²³ Includes special shafts & spacers

²⁴ Special 10° 4 groove lock. Single groove use Part #612-16.

CHRYSLER 273-360 C.I. 8 CYL. 1964-2003 (CONTINUED)

CAMSHAFTS CHRYSLER

K-KIT	SK-KIT	CL-KIT	RP-KIT	LIFTERS	TIMING SET	ROCKER ARMS	PUSHRODS	VALVE SPRINGS	RETAINERS	VALVE LOCKS	VALVE SEALS
XTREME ENERGY™ Mechanical Roller Camshafts											
K20-743-9 ⁵	N/A	CL20-743-9 ^{5,7}	RP1623-16	828-16 ¹³	2103 3103	1622-16 ²³	7970-16	914-16 ²	748-16 1732-16	626-16 ²⁴	505-16 ²
K20-742-9 ⁵	N/A	CL20-742-9 ^{5,7}	RP1623-16	828-16 ¹³	2103 3103	1622-16 ²³	7970-16	914-16 ²	748-16 1732-16	626-16 ²⁴	505-16 ²
K20-741-9 ⁵	N/A	CL20-741-9 ^{5,7}	RP1623-16	828-16 ¹³	2103 3103	1622-16 ²³	7970-16	914-16 ²	748-16 1732-16	626-16 ²⁴	505-16 ²
K20-740-9 ⁵	N/A	CL20-740-9 ^{5,7}	RP1623-16	828-16 ¹³	2103 3103	1622-16 ²³	7970-16	914-16 ²	748-16 1732-16	626-16 ²⁴	505-16 ²
LIFTERS	TIMING SET	ROCKER ARMS	PUSHRODS	VALVE SPRINGS	RETAINERS	VALVE LOCKS	VALVE SEALS	LASH CAPS	REV KIT	DIST. GEAR	STUD GIRDLES
DRAG RACE Mechanical Roller Camshafts											
828-16 ¹³ 8043-16 ⁷⁶	3103	1622-16 ²³	7970-16	943-16 ² 26099-16 ²	731-16 733-16	626-16 ²⁴	505-16 ²	622-16	N/A	420	N/A
828-16 ¹³ 8043-16 ⁷⁶	3103	1622-16 ²³	7970-16	943-16 ² 26099-16 ²	731-16 733-16	626-16 ²⁴	505-16 ²	622-16	N/A	420	N/A
828-16 ¹³ 8043-16 ⁷⁶	3103	1622-16 ²³	7970-16	943-16 ² 951-16 ²	731-16 733-16	626-16 ²⁴	505-16 ²	622-16	N/A	420	N/A
828-16 ¹³ 8043-16 ⁷⁶	3103	1622-16 ²³	7970-16	943-16 ² 951-16 ²	731-16 733-16	626-16 ²⁴	505-16 ²	622-16	N/A	420	N/A
828-16 ¹³ 8043-16 ⁷⁶	3103	1622-16 ²³	7970-16	943-16 ² 951-16 ²	731-16 733-16	626-16 ²⁴	505-16 ²	622-16	N/A	420	N/A
OVAL TRACK RACE Mechanical Roller Camshafts											
828-16 ¹³ 8043-16 ⁷⁶	3103	1622-16 ²³	7970-16	943-16 ² 26099-16 ²	731-16 733-16	626-16 ²⁴	505-16 ²	622-16	N/A	420	N/A
828-16 ¹³ 8043-16 ⁷⁶	3103	1622-16 ²³	7970-16	943-16 ² 26099-16 ²	731-16 733-16	626-16 ²⁴	505-16 ²	622-16	N/A	420	N/A

⁷⁶ Oils through pushrods

DODGE 5.7L & 6.1L HEMI 2003-PRESENT

APPLICATIONS/CAMSHAFTS	VALVE SETTING		RPM OPERATING RANGE	CAM PART #	CAM GRIND #	DURATION				VALVE LIFT		LOBE SEP. ANGLE
	IN.	EX.				ADVERTISED IN.	EX.	@ .050" IN.	EX.	W/ 1.6 ROCKER IN.	EX.	
XTREME FUEL INJECTION (XFI™) Hydraulic Roller Camshafts												
HYDRAULIC ROLLER – Slight noticeable idle, slight tuning modifications, excellent torque throughout range. Needs programmer.	Hyd.	Hyd.	1000 to 5500	112-500-11	260H-13	260	264	208	212	.522	.525	113°
HYDRAULIC ROLLER – Noticeable idle, moderate tuning modifications, strong mid-range. Needs programmer.	Hyd.	Hyd.	1500 to 5800	112-501-11	268H-13	268	272	216	220	.528	.531	113°
HYDRAULIC ROLLER – Needs extended rev limit and better exhaust, strongest power over 2500 RPM. Requires custom tuning.	Hyd.	Hyd.	2000 to 6200	112-502-11	273H-14	273	277	224	228	.547	.550	114°
TRI-POWER XTREME™ Hydraulic Roller Camshafts												
HYDRAULIC ROLLER – Optimized fuel mileage with good torque and horsepower. Needs programmer.	Hyd.	Hyd.	800 to 5000	112-525-11	TPX 246HR-16	246	258	194	206	.470	.464	116°
HYDRAULIC ROLLER – Exceptional torque w/ good HP & moderate fuel economy. Needs programmer.	Hyd.	Hyd.	1000 to 5400	112-530-11	TPX 254HR-15	254	264	202	212	.477	.470	115°
HYDRAULIC ROLLER – Optimized horsepower w/ good torque & average fuel economy. Needs programmer.	Hyd.	Hyd.	1200 to 5700	112-535-11	TPX 262HR-14	262	270	210	218	.483	.477	114°

DODGE 5.7L & 6.4L HEMI 2010-PRESENT (W/ VVT)

APPLICATIONS/CAMSHAFTS	VALVE SETTING		RPM OPERATING RANGE	CAM PART #	CAM GRIND #	DURATION				VALVE LIFT		LOBE SEP. ANGLE
	IN.	EX.				ADVERTISED IN.	EX.	@ .050" IN.	EX.	W/ 1.6 ROCKER IN.	EX.	
XTREME FUEL INJECTION (XFI™) Hydraulic Roller Camshafts												
HYDRAULIC ROLLER – Good improvements over the factory Apache camshaft.	Hyd.	Hyd.	1800 to 6800	201-424-17	266W14	266	279	218	226	.612	.605	114°
HYDRAULIC ROLLER – Best all around performance grind for 6.4L applications.	Hyd.	Hyd.	2100 to 7100	201-426-17	270W15	270	283	222	230	.615	.609	115°
HYDRAULIC ROLLER – Requires either added displacement or high RPM modifications in street/strip applications.	Hyd.	Hyd.	2400 to 7400	201-428-17	274W16	274	287	226	234	.619	.612	116°

CHRYSLER 383-440 C.I. 8 CYL. 1959-1980

APPLICATIONS/CAMSHAFTS	VALVE SETTING		RPM OPERATING RANGE	CAM PART #	CAM GRIND #	DURATION				VALVE LIFT		LOBE SEP. ANGLE
	IN.	EX.				ADVERTISED IN.	EX.	@ .050" IN.	EX.	W/ 1.5 ROCKER IN.	EX.	
HIGH ENERGY™ Hydraulic Flat Tappet Camshafts												
HYDRAULIC – Excellent torque & mileage for 383-400, 2 or 4 BBL. Smooth idle. Light towing, 9:1 compression.	Hyd.	Hyd.	800 to 4800	21-212-4 Single-Bolt	252H	252	252	206	206	.425	.425	110°
HYDRAULIC – OEM replacement for 383, 440. 9:1 compression. Smooth idle. Good for towing. Use 625 CFM carb and dual plane manifold.	Hyd.	Hyd.	1000 to 5000	21-213-4 Single-Bolt	260H	260	260	212	212	.440	.440	110°
HYDRAULIC – Great replacement for 383 Magnum with 650-750 CFM carb, dual plane manifold, etc. Smooth idle 440, super torque.	Hyd.	Hyd.	1200 to 5200	21-215-4 Single-Bolt	268H	268	268	218	218	.454	.454	110°

⁷ Stock springs cannot be used

²³ Includes special shafts & spacers

²⁶ 1/2 set 2 groove; 1/2 set 4 groove

DODGE 5.7L & 6.1L HEMI 2003-PRESENT

LIFTERS	TIMING SET	ROCKER ARMS	PUSHRODS	VALVE SPRINGS	RETAINERS	VALVE LOCKS	VALVE SEALS	LASH CAPS	REV KIT	DIST. GEAR	STUD GIRDLES	
XTREME FUEL INJECTION (XFI™) Hydraulic Roller Camshafts												
N/A	7114	N/A	7914-16	26918-16	761-16 762-16	N/A	N/A	N/A	N/A	N/A	N/A	
N/A	7114	N/A	7914-16	26918-16	761-16 762-16	N/A	N/A	N/A	N/A	N/A	N/A	
N/A	7114	N/A	7914-16	26918-16	761-16 762-16	N/A	N/A	N/A	N/A	N/A	N/A	
TRI-POWER XTREME™ Hydraulic Roller Camshafts												
N/A	7114	N/A	7914-16	26918-16	761-16 762-16	N/A	N/A	N/A	N/A	N/A	N/A	
N/A	7114	N/A	7914-16	26918-16	761-16 762-16	N/A	N/A	N/A	N/A	N/A	N/A	
N/A	7114	N/A	7914-16	26918-16	761-16 762-16	N/A	N/A	N/A	N/A	N/A	N/A	

DODGE 5.7L & 6.4L HEMI 2010-2012 (W/ VVT)

LIFTERS	PHASER LOCK KIT	PHASER LIMITER KIT	PUSHRODS	VALVE SPRINGS	RETAINERS	VALVE LOCKS	VALVE SEALS	LASH CAPS	REV KIT	DIST. GEAR	STUD GIRDLES
XTREME FUEL INJECTION (XFI™) Hydraulic Roller Camshafts											
N/A	5761	5760	N/A	N/A	N/A	N/A	N/A	N/A	N/A	N/A	N/A
N/A	5761	5760	N/A	N/A	N/A	N/A	N/A	N/A	N/A	N/A	N/A
N/A	5761	5760	N/A	N/A	N/A	N/A	N/A	N/A	N/A	N/A	N/A

CHRYSLER 383-440 C.I. 8 CYL. 1959-1980

K-KIT	SK-KIT	CL-KIT	RP-KIT	LIFTERS	TIMING SET	ROCKER ARMS	PUSHRODS	VALVE SPRINGS	RETAINERS	VALVE LOCKS	VALVE SEALS
HIGH ENERGY™ Hydraulic Flat Tappet Camshafts											
K21-212-4	SK21-212-4	CL21-212-4	N/A	822-16 ⁶¹	3204 2104	1621-16 ²³	N/A	926-16	744-16	606-16 ²⁶	504-16
K21-213-4	SK21-213-4 ⁷	CL21-213-4 ⁷	N/A	822-16 ⁶¹	3204 2104	1621-16 ²³	N/A	926-16	744-16	606-16 ²⁶	504-16
K21-215-4	SK21-215-4 ⁷	CL21-215-4 ⁷	N/A	822-16 ⁶¹	3204 2104	1621-16 ²³	N/A	926-16	744-16	606-16 ²⁶	504-16

⁶¹ Pre-1968 use Part #824-16 lifters

RED NUMBERS DENOTE PREMIUM OPTION

CHRYSLER 383-440 C.I. 8 CYL. 1959-1980 (CONTINUED)

APPLICATIONS/CAMSHAFTS	VALVE SETTING		RPM OPERATING RANGE	CAM PART #	CAM GRIND #	DURATION				VALVE LIFT		LOBE SEP. ANGLE
	IN.	EX.				IN.	EX.	IN.	EX.	IN.	EX.	
MAGNUM Hydraulic Flat Tappet Camshafts												
HYDRAULIC – Great replacement for 440 with 700-800 CFM or six pack. Noticeable idle in 383. Slight idle in 440. Largest cam w/ stock converter.	Hyd.	Hyd.	1800 to 5500	21-306-4 Single-Bolt	270H	270	270	224	224	.470	.470	110°
HYDRAULIC – For 9:1-10:1 compression. 383 needs 2500 stall. 440 needs 2000+ stall. Use 700-800 CFM carburetor, headers, 3.91+ gears.	Hyd.	Hyd.	2500 to 5800	21-237-4 Single-Bolt	280H	280	280	231	231	.480	.480	110°
HYDRAULIC – Serious street/strip effort. 383 needs 3000-3500+ stall. 440 needs 2500-3000. 750 to 800 CFM carb and headers, 3.91+ gear.	Hyd.	Hyd.	3000 to 6200	21-242-4²⁸ Single-Bolt	292H	292	292	244	244	.501	.501	110°
HYDRAULIC – Pro Street. 383 needs 3500-3700+ stall. 440 needs 3000-3300+ stall. 850 CFM carb, 10:1+ compression. Headers and good int, 3.90-4.30 gear.	Hyd.	Hyd.	3500 to 6500	21-243-4²⁸ Single-Bolt	305H	305	305	253	253	.525	.525	110°
XTREME ENERGY™ Hydraulic Flat Tappet Camshafts												
HYDRAULIC – Very strong torque, excellent mileage, smooth idle.	Hyd.	Hyd.	600 to 4800	21-220-4 Single-Bolt	XE250H	250	260	206	212	.432	.444	110°
HYDRAULIC – Strong torque through low end and mid-range, good idle.	Hyd.	Hyd.	1000 to 5200	21-221-4 Single-Bolt	XE256H	256	268	212	218	.447	.455	110°
HYDRAULIC – Excellent response, good mileage, stock converter, 3.23 gear.	Hyd.	Hyd.	1300 to 5600	21-222-4 Single-Bolt	XE262H	262	270	218	224	.462	.470	110°
HYDRAULIC – Great for street machines, slightly rough idle works with stock converter but best with 1800+ stall.	Hyd.	Hyd.	1600 to 5800	21-223-4²⁸ Single-Bolt	XE268H	268	280	224	230	.477	.480	110°
HYDRAULIC – High performance street. Very strong mid-range with headers, 2200+ stall.	Hyd.	Hyd.	1800 to 6000	21-224-4²⁸ Single-Bolt	XE274H	274	286	230	236	.488	.491	110°
HYDRAULIC – Street/strip, needs 2800+ stall, 9:1 compression, rough idle.	Hyd.	Hyd.	2300 to 6500	21-225-4²⁸ Single-Bolt	XE284H	284	296	240	246	.507	.510	110°
HYDRAULIC – Pro Street/bracket, good intake, headers, gear, 3200+ stall.	Hyd.	Hyd.	2800 to 6800	21-226-4²⁸ Single-Bolt	XE294H	294	306	250	256	.519	.524	110°
THUMPR™ Hydraulic Flat Tappet Camshafts												
HYDRAULIC – Thumpr™ – High performance street, stock converter ok, best w/ 2000+ stall & gears. Choppy/thumping idle.	Hyd.	Hyd.	2000 to 5800	21-600-5²⁸ Single-Bolt	279TH7	279	296	227	241	.486	.473	107°
HYDRAULIC – Mutha' Thumpr™ – High performance street/strip, needs 9:1 compression, 2500+ stall, intake, gears and headers, rough idle.	Hyd.	Hyd.	2200 to 6100	21-601-5²⁸ Single-Bolt	287TH7	287	304	235	249	.497	.483	107°
HYDRAULIC – Big Mutha' Thumpr™ – Street/strip, needs 9.5:1 compression, 2800+ stall, intake, gears and headers, very rough idle.	Hyd.	Hyd.	2500 to 6400	21-602-5²⁸ Single-Bolt	295TH7	295	312	243	257	.507	.494	107°
XTREME ENERGY™ HI-LIFT Hydraulic Flat Tappet Camshafts												
HYDRAULIC – Best all around street performance cam. 9:1 compression with 2500+ stall. Extra lift for upper RPM power.	Hyd.	Hyd.	2000 to 5800	21-227-4²⁸ Single-Bolt	XE275HL	275	287	231	237	.525	.525	110°
HYDRAULIC – Hot street cam. 10:1 compression, lower gears, headers & 3000+ stall. Strong mid-range w/ rough idle.	Hyd.	Hyd.	2500 to 6200	21-228-4²⁸ Single-Bolt	XE285HL	285	297	241	247	.545	.545	110°
HYDRAULIC – Serious street and bracket race cam. 10:1 compression, lower gears, headers and 3500+ stall.	Hyd.	Hyd.	3000 to 6500	21-229-4²⁸ Single-Bolt	XE295HL	295	307	251	257	.564	.564	110°

² Requires machining on cylinder heads

⁷ Stock springs cannot be used

²³ Includes special shafts & spacers

²⁶ 1/2 set 2 groove; 1/2 set 4 groove

²⁸ 3-bolt core available. Change first 2 digits of part # to 23.

CHRYSLER 383-440 C.I. 8 CYL. 1959-1980 (CONTINUED)

CAMSHAFTS CHRYSLER

K-KIT	SK-KIT	CL-KIT	RP-KIT	LIFTERS	TIMING SET	ROCKER ARMS	PUSHRODS	VALVE SPRINGS	RETAINERS	VALVE LOCKS	VALVE SEALS
MAGNUM Hydraulic Flat Tappet Camshafts											
K21-306-4	SK21-306-4 ⁷	CL21-306-4 ⁷	N/A	822-16 ⁶¹ 867-16 ³⁷	2104 3104	1621-16 ²³	N/A	911-16 924-16 ²	748-16 741-16	627-16 ²⁶	504-16 505-16 ²
K21-237-4	SK21-237-4 ⁷	CL21-237-4 ⁷	N/A	822-16 ⁶¹ 867-16 ³⁷	2104 3104	1621-16 ²³	N/A	911-16 924-16 ²	748-16 741-16	627-16 ²⁶	504-16 505-16 ²
K21-242-4	SK21-242-4 ⁷	CL21-242-4 ⁷	N/A	822-16 ⁶¹ 867-16 ³⁷	2104 3104	1621-16 ²³ 1071-KIT ²³	N/A	924-16 ² 26120-16 ²	741-16 795-16	627-16 ²⁶	505-16 ²
K21-243-4	SK21-243-4 ⁷	CL21-243-4 ⁷	N/A	822-16 ⁶¹ 867-16 ³⁷	2104 3104	1621-16 ²³ 1071-KIT ²³	N/A	924-16 ² 26120-16 ²	741-16 795-16	627-16 ²⁶	505-16 ²
XTREME ENERGY™ Hydraulic Flat Tappet Camshafts											
K21-220-4	SK21-220-4 ⁷	CL21-220-4 ⁷	N/A	822-16 ⁶¹	3204 2104	1621-16 ²³	N/A	926-16	744-16	606-16 ²⁶	504-16
K21-221-4	SK21-221-4 ⁷	CL21-221-4 ⁷	N/A	822-16 ⁶¹	3204 2104	1621-16 ²³	N/A	926-16	744-16	606-16 ²⁶	504-16
K21-222-4	SK21-222-4 ⁷	CL21-222-4 ⁷	N/A	822-16 ⁶¹ 867-16 ³⁷	3204 2104	1621-16 ²³	N/A	911-16 925-16 ²	748-16 741-16	627-16 ²⁶	504-16 505-16 ²
K21-223-4	SK21-223-4 ⁷	CL21-223-4	N/A	822-16 ⁶¹ 867-16 ³⁷	3204 2104	1621-16 ²³	N/A	911-16 925-16 ²	748-16 741-16	627-16 ²⁶	504-16 505-16 ²
K21-224-4	SK21-224-4 ⁷	CL21-224-4 ⁷	N/A	822-16 ⁶¹ 867-16 ³⁷	3204 2104	1621-16 ²³ 1071-KIT ²³	N/A	911-16 925-16 ²	748-16 741-16	627-16 ²⁶	504-16 505-16 ²
K21-225-4	SK21-225-4 ⁷	CL21-225-4 ⁷	N/A	822-16 ⁶¹ 867-16 ³⁷	3204 2104	1621-16 ²³ 1071-KIT ²³	N/A	911-16 925-16 ²	748-16 741-16	627-16 ²⁶	504-16 505-16 ²
K21-226-4	SK21-226-4 ⁷	CL21-226-4 ⁷	N/A	822-16 ⁶¹ 867-16 ³⁷	3204 2104	1621-16 ²³ 1071-KIT ²³	N/A	925-16 ² 26120-16 ²	748-16 795-16	627-16 ²⁶	505-16 ²
THUMPR™ Hydraulic Flat Tappet Camshafts											
K21-600-5	N/A	CL21-600-5 ⁷	N/A	822-16 ⁶¹ 867-16 ³⁷	2104 3104	1621-16 ²³ 1071-KIT ²³	N/A	911-16 925-16 ²	748-16 741-16	627-16 ²⁶	505-16 ²
K21-601-5	N/A	CL21-601-5 ⁷	N/A	822-16 ⁶¹ 867-16 ³⁷	2104 3104	1621-16 ²³ 1071-KIT ²³	N/A	911-16 925-16 ²	748-16 741-16	627-16 ²⁶	505-16 ²
K21-602-5	N/A	CL21-602-5 ⁷	N/A	822-16 ⁶¹ 867-16 ³⁷	2104 3104	1621-16 ²³ 1071-KIT ²³	N/A	911-16 925-16 ²	748-16 741-16	627-16 ²⁶	505-16 ²
XTREME ENERGY™ HI-LIFT Hydraulic Flat Tappet Camshafts											
K21-227-4	SK21-227-4 ⁷	CL21-227-4 ⁷	N/A	822-16 ⁶¹ 867-16 ³⁷	2104 3104	1621-16 ²³ 1071-KIT ²³	N/A	924-16 ² 26120-16 ²	741-16 795-16	627-16 ²⁶	505-16 ²
K21-228-4	SK21-228-4 ⁷	CL21-228-4 ⁷	N/A	822-16 ⁶¹ 867-16 ³⁷	2104 3104	1621-16 ²³ 1071-KIT ²³	N/A	924-16 ² 26120-16 ²	741-16 795-16	627-16 ²⁶	505-16 ²
K21-229-4	SK21-229-4 ⁷	CL21-229-4 ⁷	N/A	822-16 ⁶¹ 867-16 ³⁷	2104 3104	1621-16 ²³ 1071-KIT ²³	N/A	924-16 ² 26120-16 ²	741-16 795-16	627-16 ²⁶	505-16 ²

³⁷ Adjustable valve train required

⁶¹ Pre-1968 use Part #824-16 lifters

CHRYSLER 383-440 C.I. 8 CYL. 1959-1980 (CONTINUED)

APPLICATIONS/CAMSHAFTS	VALVE SETTING		RPM OPERATING RANGE	CAM PART #	CAM GRIND #	DURATION				VALVE LIFT		LOBE SEP. ANGLE
	IN.	EX.				IN.	EX.	IN.	EX.	IN.	EX.	
DUAL ENERGY™ Hydraulic Flat Tappet Camshafts												
HYDRAULIC – Good torque and mileage, good RV and towing cam.	Hyd.	Hyd.	1000 to 5000	21-402-4 Single-Bolt	255DEH	255	275	205	219	.422	.462	110°
HYDRAULIC – Very strong mid-range and torque, mild performance cam.	Hyd.	Hyd.	1500 to 5250	21-404-4 Single-Bolt	265DEH	265	277	214	229	.442	.482	110°
HYDRAULIC – High performance street, good mid-range and high end, choppy idle.	Hyd.	Hyd.	1800 to 5500	21-406-4 Single-Bolt	275DEH	275	284	219	235	.462	.482	110°
NOSTALGIA PLUS™ Hydraulic Flat Tappet Camshafts												
HYDRAULIC – 2500 stall with 9.5:1 compression, strong mid-range with early muscle car sound.	Hyd.	Hyd.	2000 to 6000	21-670-4 Single-Bolt	PP280H	280	287	233	240	.474	.474	110°
HYDRAULIC – Strong mid-range w/ a lopey idle, 2800+ stall w/ 9.5:1 compression, replaces the popular 484 cam.	Hyd.	Hyd.	2300 to 6300	21-671-4 Single-Bolt	PP284H	284	291	239	246	.484	.484	108°
HYDRAULIC – Strong bracket/street cam. 10:1 compression. 3500+ stall. Excellent replacement for the “509” cam.	Hyd.	Hyd.	3000 to 6500	21-672-4 Single-Bolt	PP292H	292	299	247	254	.509	.509	108°

APPLICATIONS/CAMSHAFTS	VALVE SETTING		RPM OPERATING RANGE	CAM PART #	CAM GRIND #	DURATION				VALVE LIFT		LOBE SEP. ANGLE
	IN.	EX.				IN.	EX.	IN.	EX.	IN.	EX.	
MAGNUM MUSCLE Hydraulic Flat Tappet Camshafts (Today's Version Of Yesterday's Muscle Car Cams)												
HYDRAULIC – Factory I.D. #2899206 for: 383c.i., 1968-70, factory 335 HP 383c.i., 1971, factory 300 HP 440c.i., 1967-70, factory 375/390 HP 440c.i., 1971, factory 370/385 HP	Hyd.	Hyd.	1600 to 5600	21-305-4⁷ Single-Bolt	268AH-10	268	276	222	226	.464	.464	110°
XTREME ENERGY™ Retro-Fit Hydraulic Roller Camshafts												
HYDRAULIC ROLLER – 3.55-4.10 gear, 2000 stall in 440, 2200+ in 383, 9:1 compression, high performance street.	Hyd.	Hyd.	1800 to 5800	23-710-9⁷	XR274HR-10	274	282	224	230	.538	.534	110°
HYDRAULIC ROLLER – 3.91+ gear, 2500+ stall, 9.5:1 compression, aftermarket intake, headers.	Hyd.	Hyd.	2200 to 6000	23-711-9⁷	XR280HR-10	280	288	230	236	.541	.537	110°
HYDRAULIC ROLLER – 3.91+ gear, 9.5:1+ compression, 2800+ stall, needs headers, rough idle.	Hyd.	Hyd.	2500 to 6200	23-712-9⁷	XR286HR-10	286	294	236	242	.544	.541	110°
HYDRAULIC ROLLER – 4.10 gear, 3000+ stall, 10:1 compression, very rough idle, Pro Street/bracket race.	Hyd.	Hyd.	2800 to 6400	23-713-9⁷	XR292HR-10	292	300	242	248	.549	.544	110°
THUMPR™ Retro-Fit Hydraulic Roller Camshafts												
HYDRAULIC ROLLER – Thumpr™ – High performance street, stock converter ok, best with 2000+ converter and gears, choppy/thumping idle.	Hyd.	Hyd.	1900 to 5600	23-600-9⁷	283THR7	283	303	227	241	.513	.498	107°
HYDRAULIC ROLLER – Mutha' Thumpr™ – High performance street/strip, needs 9:1 compression 2500+ stall, intake, gears and headers, rough idle.	Hyd.	Hyd.	2200 to 5900	23-601-9⁷	291THR7	291	311	235	249	.522	.508	107°
HYDRAULIC ROLLER – Big Mutha' Thumpr™ – Street/strip, needs 9.5:1 compression, 2800+ stall, intake, gears and headers, very rough idle.	Hyd.	Hyd.	2500 to 6200	23-602-9⁷	299THR7	299	319	243	257	.532	.519	107°

² Requires machining on cylinder heads

⁷ Stock springs cannot be used

²³ Includes special shafts & spacers

²⁶ 1/2 set 2 groove; 1/2 set 4 groove

³⁷ Adjustable valve train required

⁶¹ Pre-1968 use Part #824-16 lifters

CHRYSLER 383-440 C.I. 8 CYL. 1959-1980 (CONTINUED)

K-KIT	SK-KIT	CL-KIT	RP-KIT	LIFTERS	TIMING SET	ROCKER ARMS	PUSHRODS	VALVE SPRINGS	RETAINERS	VALVE LOCKS	VALVE SEALS
DUAL ENERGY™ Hydraulic Flat Tappet Camshafts											
K21-402-4	SK21-402-4 ⁷	CL21-402-4 ⁷	N/A	822-16 ⁶¹	2104 3104	1621-16 ²³	N/A	911-16 924-16 ²	748-16 741-16	627-16 ²⁶	504-16 505-16 ²
K21-404-4	SK21-404-4 ⁷	CL21-404-4 ⁷	N/A	822-16 ⁶¹	2104 3104	1621-16 ²³	N/A	911-16 924-16 ²	748-16 741-16	627-16 ²⁶	504-16 505-16 ²
K21-406-4	SK21-406-4 ⁷	CL21-406-4 ⁷	N/A	822-16 ⁶¹ 867-16 ³⁷	2104 3104	1621-16 ²³	N/A	911-16 924-16 ²	748-16 741-16	627-16 ²⁶	504-16 505-16 ²
NOSTALGIA PLUS™ Hydraulic Flat Tappet Camshafts											
K21-670-4	N/A	CL21-670-4 ⁷	N/A	822-16 ⁶¹ 867-16 ³⁷	2104 3104	1621-16 ²³	N/A	911-16 924-16 ²	748-16 741-16	627-16 ²⁶	504-16 505-16 ²
K21-671-4	N/A	CL21-671-4 ⁷	N/A	822-16 ⁶¹ 867-16 ³⁷	2104 3104	1621-16 ²³	N/A	911-16 924-16 ²	748-16 741-16	627-16 ²⁶	504-16 505-16 ²
K21-672-4	N/A	CL21-672-4 ⁷	N/A	822-16 ⁶¹ 867-16 ³⁷	2104 3104	1621-16 ²³ 1071-KIT ²³	N/A	924-16 ² 26120-16 ²	741-16 795-16	627-16 ²⁶	505-16 ²
LIFTERS	TIMING SET	ROCKER ARMS	PUSHRODS	VALVE SPRINGS	RETAINERS	VALVE LOCKS	VALVE SEALS	LASH CAPS	REV KIT	DIST. GEAR	STUD GIRDLES
MAGNUM MUSCLE Hydraulic Flat Tappet Camshafts (Today's Version Of Yesterday's Muscle Car Cams)											
822-16 ⁶¹ 867-16 ³⁷	2104 3104	1621-16 ²³ 1071-KIT ²³	N/A	926-16 924-16 ²	744-16 741-16	606-16 627-16 ²⁶	504-16 505-16 ²	622-16	N/A	424	N/A
XTREME ENERGY™ Retro-Fit Hydraulic Roller Camshafts											
8921-16	3125 3125KT	1621-16 ²³ 1071-KIT ²³	N/A	925-16 ² 26120-16 ²	741-16 795-16	627-16 ²⁶	505-16 ²	622-16	N/A	N/A	N/A
8921-16	3125 3125KT	1621-16 ²³ 1071-KIT ²³	N/A	925-16 ² 26120-16 ²	741-16 795-16	627-16 ²⁶	505-16 ²	622-16	N/A	N/A	N/A
8921-16	3125 3125KT	1621-16 ²³ 1071-KIT ²³	N/A	925-16 ² 26120-16 ²	741-16 795-16	627-16 ²⁶	505-16 ²	622-16	N/A	N/A	N/A
8921-16	3125 3125KT	1621-16 ²³ 1071-KIT ²³	N/A	925-16 ² 26120-16 ²	741-16 795-16	627-16 ²⁶	505-16 ²	622-16	N/A	N/A	N/A
THUMPR™ Retro-Fit Hydraulic Roller Camshafts											
8921-16	3125 3125KT	1621-16 ²³ 1071-KIT ²³	N/A	925-16 ² 26120-16 ²	741-16 795-16	627-16 ²⁶	505-16 ²	622-16	N/A	N/A	N/A
8921-16	3125 3125KT	1621-16 ²³ 1071-KIT ²³	N/A	925-16 ² 26120-16 ²	741-16 795-16	627-16 ²⁶	505-16 ²	622-16	N/A	N/A	N/A
8921-16	3125 3125KT	1621-16 ²³ 1071-KIT ²³	N/A	925-16 ² 26120-16 ²	741-16 795-16	627-16 ²⁶	505-16 ²	622-16	N/A	N/A	N/A

RED NUMBERS DENOTE PREMIUM OPTION



CHRYSLER 383-440 C.I. 8 CYL. 1959-1980 (CONTINUED)

APPLICATIONS/CAMSHAFTS	VALVE SETTING		RPM OPERATING RANGE	CAM PART #	CAM GRIND #	DURATION				VALVE LIFT		LOBE SEP. ANGLE
	IN.	EX.				IN.	EX.	IN.	EX.	IN.	EX.	
MAGNUM Mechanical Flat Tappet Camshafts												
SOLID – Good with stock converter. Near smooth idle in 440. Works good with 650-750 CFM carb. Excellent torque.	.022	.022	2000 to 5500	21-246-4 Single-Bolt	270S	270	270	224	224	.468	.468	110°
SOLID – Excellent for street/strip. 383 needs 2800 stall. 440 use 2400 stall, 700-800 CFM carb and headers.	.022	.022	2500 to 5800	21-247-4 Single-Bolt	282S	282	282	236	236	.495	.495	110°
SOLID – Max street 383. 3500 converter. 10:1 compression. 750+ CFM and headers. 3000+ stall for 440, 800 CFM, 3.91-4.30 gear.	.022	.022	3000 to 6200	21-248-4²⁸ Single-Bolt	294S	294	294	250	250	.525	.525	110°
SOLID – Serious street/strip effort for 440. 3500 converter. 10.5:1+ compression. 800-850 CFM. 383 requires 4000+ converter.	.022	.022	3500 to 6500	21-249-4²⁸ Single-Bolt	306S	306	306	262	262	.555	.555	110°
XTREME ENERGY™ Mechanical Flat Tappet Camshafts												
SOLID – Excellent for street and mild strip, 2200+ stall or 4 speed.	.016	.018	1800 to 5800	21-230-4²⁸ Single-Bolt	XS268S	268	274	230	236	.488	.501	110°
SOLID – Serious street/strip, 9.5:1 compression with 2800+ stall. Strong mid-range.	.016	.018	2200 to 6200	21-231-4²⁸ Single-Bolt	XS274S	274	280	236	242	.502	.511	110°
SOLID – Very strong mid and upper RPM power. 10:1 compression with 3000+ stall.	.016	.018	2500 to 6500	21-232-4²⁸ Single-Bolt	XS282S	282	290	244	252	.520	.540	110°
SOLID – Max effort street/bracket race cam. 10.5:1 compression, 3500+ stall and low gears.	.016	.018	3200 to 7000	21-233-4²⁸ Single-Bolt	XS290S	290	298	252	260	.540	.558	110°
DRAG RACE Mechanical Flat Tappet Camshafts												
SOLID – Good bracket cam. 10.5:1+ compression, 3500+ stall in 440, 3800+ in 383.	.018	.020	3500 to 6500	23-631-5 Three-Bolt	XTQ286S-8	286	296	256	266	.550	.570	108°
SOLID – Best with 11:1 compression in 383 with 4500+ stall, 4200+ stall with 440. Strong mid-range.	.018	.020	3800 to 6800	23-632-5 Three-Bolt	XTQ294S-8	294	299	264	270	.567	.579	108°
SOLID – Good Super Street, Super Gas or bracket cam. Best with 12:1 compression in 440 with 5000+ stall or 5500+ stall in 383.	.018	.020	4500 to 7200	23-633-5 Three-Bolt	TL304S-8	302	311	274	282	.590	.609	108°
SOLID – Great Super Street, Super Gas or bracket cam. Best in 470+ engines w/ 12:1 compression & 5500+ stall.	.020	.022	5000 to 7500	23-634-5 Three-Bolt	MM 305S-10	305	320	279	287	.650	.630	110°
SOLID – 440 with 5500+ stall, 5.13 gear, 11:1+ compression, 850+ CFM carb.	.028	.030	5000 to 7200	23-630-5 Three-Bolt	324A-8	324	324	290	290	.650	.650	108°

² Requires machining on cylinder heads

⁷ Stock springs cannot be used

²³ Includes special shafts & spacers

²⁶ 1/2 set 2 groove; 1/2 set 4 groove

⁷⁶ Oils through pushrods

CHRYSLER 383-440 C.I. 8 CYL. 1959-1980 (CONTINUED)

K-KIT	SK-KIT	CL-KIT	RP-KIT	LIFTERS	TIMING SET	ROCKER ARMS	PUSHRODS	VALVE SPRINGS	RETAINERS	VALVE LOCKS	VALVE SEALS
MAGNUM Mechanical Flat Tappet Camshafts											
K21-246-4	SK21-246-4 ⁷	CL21-246-4 ⁷	N/A	821-16 801-16 ⁷⁶	2104 3104	1621-16 ²³	N/A	911-16 924-16 ²	748-16 741-16	627-16 ²⁶	504-16 505-16 ²
K21-247-4	SK21-247-4 ⁷	CL21-247-4 ⁷	N/A	821-16 801-16 ⁷⁶	2104 3104	1621-16 ²³	N/A	911-16 924-16 ²	748-16 741-16	627-16 ²⁶	504-16 505-16 ²
K21-248-4	SK21-248-4 ⁷	CL21-248-4 ⁷	N/A	821-16 801-16 ⁷⁶	2104 3104	1621-16 ²³	N/A	924-16 ² 26120-16 ²	741-16 795-16	627-16 ²⁶	505-16 ²
K21-249-4	SK21-249-4 ⁷	CL21-249-4 ⁷	N/A	821-16 801-16 ⁷⁶	2104 3104	1621-16 ²³ 1071-KIT ²³	N/A	924-16 ² 26120-16 ²	741-16 795-16	627-16 ²⁶	505-16 ²
XTREME ENERGY™ Mechanical Flat Tappet Camshafts											
K21-230-4	N/A	CL21-230-4 ⁷	N/A	821-16 801-16 ⁷⁶	2104 3104	1621-16 ²³ 1071-KIT ²³	N/A	911-16 924-16 ²	748-16 741-16	627-16 ²⁶	504-16 505-16 ²
K21-231-4	N/A	CL21-231-4 ⁷	N/A	821-16 801-16 ⁷⁶	2104 3104	1621-16 ²³ 1071-KIT ²³	N/A	924-16 ² 26120-16 ²	741-16 795-16	627-16 ²⁶	505-16 ²
K21-232-4	N/A	CL21-232-4 ⁷	N/A	821-16 801-16 ⁷⁶	2104 3104	1621-16 ²³ 1071-KIT ²³	N/A	924-16 ² 26120-16 ²	741-16 795-16	627-16 ²⁶	505-16 ²
K21-233-4	N/A	CL21-233-4 ⁷	N/A	821-16 801-16 ⁷⁶	2104 3104	1621-16 ²³ 1071-KIT ²³	N/A	924-16 ² 26120-16 ²	741-16 795-16	627-16 ²⁶	505-16 ²
LIFTERS	TIMING SET	ROCKER ARMS	PUSHRODS	VALVE SPRINGS	RET.	VALVE LOCKS	VALVE SEALS	LASH CAPS	REV KIT	DIST. GEAR	STUD GIRDLES
DRAG RACE Mechanical Flat Tappet Camshafts											
821-16 801-16 ⁷⁶	3125 3125KT	1621-16 ²³ 1071-KIT ²³	N/A	925-16 ²	732-16	627-16 ²⁶	505-16 ²	622-16	N/A	N/A	N/A
821-16 801-16 ⁷⁶	3125 3125KT	1621-16 ²³ 1071-KIT ²³	N/A	925-16 ²	732-16	627-16 ²⁶	505-16 ²	622-16	N/A	N/A	N/A
821-16 801-16 ⁷⁶	3125 3125KT	1621-16 ²³ 1071-KIT ²³	N/A	925-16 ²	732-16	627-16 ²⁶	505-16 ²	622-16	N/A	N/A	N/A
821-16 801-16 ⁷⁶	3125 3125KT	1621-16 ²³ 1071-KIT ²³	N/A	925-16 ²	732-16	627-16 ²⁶	505-16 ²	622-16	N/A	N/A	N/A
821-16 801-16 ⁷⁶	3125 3125KT	1621-16 ²³ 1071-KIT ²³	N/A	925-16 ²	732-16	627-16 ²⁶	505-16 ²	622-16	N/A	N/A	N/A

²⁸ 3-bolt core available. Change first 2 digits of part # to 23.



CHRYSLER 383-440 C.I. 8 CYL. 1959-1980 (CONTINUED)

APPLICATIONS/CAMSHAFTS	VALVE SETTING		RPM OPERATING RANGE	CAM PART #	CAM GRIND #	DURATION				VALVE LIFT		LOBE SEP. ANGLE
	IN.	EX.				IN.	EX.	IN.	EX.	W/ 1.5 ROCKER	IN.	
MAGNUM Mechanical Roller Camshafts												
MECHANICAL ROLLER – Great all around power in 383 & 400. 750-830 CFM carb. 3500+ converter in 383. 3000+ in 440. Super torque & driveability, 4.10-4.56 gear.	.020	.020	3000 to 6200	23-741-9⁵ Three-Bolt	288R-10	288	288	243	243	.550	.550	110°
MECHANICAL ROLLER – Max street effort. 383 requires 4000+ converter. 750-830 CFM. 4.30-4.88 gear. 440 needs 3500+ converter. 800-850 CFM carb, headers. 4.10-4.56 gear.	.020	.020	3500 to 6500	23-742-9⁵ Three-Bolt	308R-10	308	308	262	262	.575	.575	110°
XTREME ENERGY™ Mechanical Street Roller Camshafts												
MECHANICAL ROLLER – Best all around street roller. 9.5:1 compression with 2500+ stall.	.016	.018	2000 to 6000	23-700-9⁵ Three-Bolt	XR274R	274	280	236	242	.564	.570	110°
MECHANICAL ROLLER – 9.5:1 with 3000+ stall. Strong mid-range with a lopey idle.	.016	.018	2500 to 6200	23-701-9⁵ Three-Bolt	XR280R	280	286	242	248	.570	.576	110°
MECHANICAL ROLLER – Serious street/strip effort, 10:1 compression with 3200+ stall.	.016	.018	3000 to 6500	23-702-9⁵ Three-Bolt	XR286R	286	292	248	254	.576	.582	110°
MECHANICAL ROLLER – Strong mid to upper RPM power, 10.5:1 compression with 3500+ stall. Radical idle.	.016	.018	3500 to 6600	23-703-9⁵ Three-Bolt	XR292R	292	297	254	260	.582	.588	110°

APPLICATIONS/CAMSHAFTS	VALVE SETTING		RPM OPERATING RANGE	CAM PART #	CAM GRIND #	DURATION				VALVE LIFT		LOBE SEP. ANGLE
	IN.	EX.				IN.	EX.	IN.	EX.	W/ 1.6 ROCKER	IN.	
DRAG RACE Mechanical Roller Camshafts												
MECHANICAL ROLLER – Super strong low end torque. Best with 10.5:1 compression and single plane intake. 3500+ stall in 440, 3800 in 383.	.026	.028	3500 to 6300	23-705-9⁵ Three-Bolt	283R-8	283	291	252	263	.660	.660	108°
MECHANICAL ROLLER – Best all around bracket or Super Street cam. Best in light to medium weight car with 11:1 compression, 4200+ stall in 440, 4500+ stall in 383.	.026	.028	4000 to 6500	23-706-9⁵ Three-Bolt	RX296R-8	296	303	263	270	.650	.651	108°
MECHANICAL ROLLER – 383 Super Gas, Super Street, 12:1+ compression, 5000+ stall.	.028	.030	4000 to 7000	23-758-9⁵ Three-Bolt	306BR-8	306	306	273	273	.625	.625	108°
MECHANICAL ROLLER – Good Super Gas, Super Street with 12:1 compression and 850+ CFM carb. 5000+ stall with 440, 5400+ with 383.	.026	.028	4500 to 7000	23-707-9⁵ Three-Bolt	RX308R-8	308	315	275	282	.657	.659	108°
MECHANICAL ROLLER – Quick 16, Super Comp for medium to large cubic inch.	.026	.028	5500 to 7800	23-704-9⁵ Three-Bolt	REV315R-6	315	321	282	288	.693	.665	106°
MECHANICAL ROLLER – Fast Bracket, Super Gas or Super Comp. Best with 12.5:1 compression and ported iron or aftermarket heads. 5500+ stall in 440.	.026	.028	4800 to 7200	23-708-9⁵ Three-Bolt	RX316R-8	316	321	283	288	.660	.663	108°
MECHANICAL ROLLER – Super Gas, Super Comp, Fast Brackets. 5000+ stall.	.028	.030	5000 to 7200	23-732-9⁵ Three-Bolt	320TR-8	320	320	288	288	.692	.692	108°
MECHANICAL ROLLER – Super Quick, Super Gas, Super Comp or Fast Brackets. For use in medium to large engines with aftermarket heads. 12.5:1 compression with 5500-6000 stall.	.026	.028	5500 to 7500	23-709-9⁵ Three-Bolt	RX322R-10	318	330	285	292	.705	.705	110°
MECHANICAL ROLLER – Super Gas, Super Street, 12:1 compression, 5000+ stall, 5.13 gear.	.028	.030	5000 to 7200	23-770-9⁵ Three-Bolt	323BR-8	323	323	289	289	.690	.690	108°

² Requires machining on cylinder heads

⁵ Requires distributor gear upgrade

⁷ Stock springs cannot be used

CHRYSLER 383-440 C.I. 8 CYL. 1959-1980 (CONTINUED)

CAMSHAFTS CHRYSLER

K-KIT	SK-KIT	CL-KIT	RP-KIT	LIFTERS	TIMING SET	ROCKER ARMS	PUSHRODS	VALVE SPRINGS	RETAINERS	VALVE LOCKS	VALVE SEALS
MAGNUM Mechanical Roller Camshafts											
K23-741-9	SK23-741-9 ⁷	CL23-741-9 ⁷	N/A	829-16	2109 3125	1621-16 ²³ 1071-KIT ²³	N/A	929-16 ² 938-16 ²	749-16 738-16	627-16 ²⁶	505-16 ²
K23-742-9	SK23-742-9 ⁷	CL23-742-9 ⁷	N/A	829-16	2109 3125	1621-16 ²³ 1071-KIT ²³	N/A	929-16 ² 938-16 ²	749-16 738-16	627-16 ²⁶	505-16 ²
XTREME ENERGY™ Mechanical Street Roller Camshafts											
K23-700-9	SK23-700-9 ⁷	CL23-700-9	N/A	829-16	2109 3125	1621-16 ²³ 1071-KIT ²³	N/A	953-16 938-16 ²	741-16 1741-16	627-16 ²⁶	505-16 ²
K23-701-9	SK23-701-9 ⁷	CL23-701-9	N/A	829-16	2109 3125	1621-16 ²³ 1071-KIT ²³	N/A	953-16 938-16 ²	741-16 1741-16	627-16 ²⁶	505-16 ²
K23-702-9	SK23-702-9 ⁷	CL23-702-9	N/A	829-16	2109 3125	1621-16 ²³ 1071-KIT ²³	N/A	953-16 938-16 ²	741-16 1741-16	627-16 ²⁶	505-16 ²
K23-703-9	SK23-703-9 ⁷	CL23-703-9	N/A	829-16	2109 3125	1621-16 ²³ 1071-KIT ²³	N/A	953-16 938-16 ²	741-16 1741-16	627-16 ²⁶	505-16 ²

LIFTERS	TIMING SET	ROCKER ARMS	PUSHRODS	VALVE SPRINGS	RETAINERS	VALVE LOCKS	VALVE SEALS	LASH CAPS	REV KIT	DIST. GEAR	STUD GIRDLES
DRAG RACE Mechanical Roller Camshafts											
829-16	3125 3125KT	1071-KIT ²³	N/A	943-16 ²	731-16	627-16 ²⁶	505-16 ²	622-16	N/A	424	N/A
829-16	3125 3125KT	1071-KIT ²³	N/A	943-16 ²	731-16	627-16 ²⁶	505-16 ²	622-16	N/A	424	N/A
829-16	3125 3125KT	1071-KIT ²³	N/A	943-16 ²	731-16	627-16 ²⁶	505-16 ²	622-16	N/A	424	N/A
829-16	3125 3125KT	1071-KIT ²³	N/A	943-16 ²	731-16	627-16 ²⁶	505-16 ²	622-16	N/A	424	N/A
829-16	3125 3125KT	1071-KIT ²³ 1073-KIT ²³	N/A	947-16 ² 26082-16 ²	739-16 722-16	627-16 ²⁶ 612-16	512-16 ²	622-16	N/A	424	N/A
829-16	3125 3125KT	1071-KIT ²³	N/A	943-16 ²	731-16	627-16 ²⁶	505-16 ²	622-16	N/A	424	N/A
829-16	3125 3125KT	1071-KIT ²³	N/A	943-16 ²	731-16	627-16 ²⁶	505-16 ²	622-16	N/A	424	N/A
829-16	3125 3125KT	1071-KIT ²³ 1073-KIT ²³	N/A	947-16 ² 26082-16 ²	739-16 722-16	627-16 ²⁶ 612-16	512-16 ²	622-16	N/A	424	N/A
829-16	3125 3125KT	1071-KIT ²³	N/A	943-16 ²	731-16	627-16 ²⁶	505-16 ²	622-16	N/A	424	N/A

²³ Includes special shafts & spacers

²⁶ 1/2 set 2 groove; 1/2 set 4 groove

CHRYSLER 392 HEMI 8 CYL. 1957-1958

APPLICATIONS/CAMSHAFTS	VALVE SETTING		RPM OPERATING RANGE	CAM PART #	CAM GRIND #	DURATION				VALVE LIFT		LOBE SEP. ANGLE
	IN.	EX.				ADVERTISED IN.	EX.	@ .050" IN.	EX.	W/ 1.57/1.52 ROCKER IN.	EX.	
STREET AND STRIP Hydraulic Flat Tappet Camshafts												
HYDRAULIC – Classic Thumpr™ – High performance street, stock converter ok, best with 2000+ converter and gears. Choppy/thumping idle.	Hyd.	Hyd.	2000-5500	26-600-5	279TH7	279	296	227	241	.486	.472	107°
HYDRAULIC – Classic Mutha' Thumpr™ – High performance street/strip, needs 9:1+ compression, 2500+ stall, intake, gears and headers, rough idle.	Hyd.	Hyd.	2200-6000	26-601-5	287TH7	287	304	235	249	.498	.483	107°
HYDRAULIC – Classic Big Mutha' Thumpr™ – Street/strip, needs 9.5:1+ compression, 2800+ stall, intake, gears and headers, very rough idle.	Hyd.	Hyd.	2500-6200	26-602-5	295TH7	295	312	243	257	.508	.495	107°

CHRYSLER 426 HEMI 8 CYL. 1966-1971

APPLICATIONS/CAMSHAFTS	VALVE SETTING		RPM OPERATING RANGE	CAM PART #	CAM GRIND #	DURATION				VALVE LIFT		LOBE SEP. ANGLE
	IN.	EX.				ADVERTISED IN.	EX.	@ .050" IN.	EX.	W/ 1.57/1.52 ROCKER IN.	EX.	
STREET AND STRIP Hydraulic Flat Tappet Camshafts												
HYDRAULIC – Good torque and power for daily driven street engines, stock converter. Slightly rough idle.	Hyd.	Hyd.	2000 to 5000	24-278-4⁷ Three-Bolt	278A-8	278	278	227	227	.502	.486	108°
HYDRAULIC – Street/strip use. 3000+ stall or 4 speed, has rough idle.	Hyd.	Hyd.	3000 to 6200	24-292-4⁷ Three-Bolt	292A-8	292	292	244	244	.534	.517	108°
THUMPR™ Hydraulic Flat Tappet Camshafts												
HYDRAULIC – Thumpr™ – High performance street, stock converter ok, best with 2000+ converter and gears. Choppy/thumping idle.	Hyd.	Hyd.	2000 to 5800	24-600-5⁷	279TH7	279	296	227	241	.508	.478	107°
HYDRAULIC – Mutha' Thumpr™ – High performance street/strip, needs 9:1 compression, 2500+ stall, intake, gears and headers, rough idle.	Hyd.	Hyd.	2200 to 6100	24-601-5⁷	287TH7	287	304	235	249	.521	.489	107°
HYDRAULIC – Big Mutha' Thumpr™ – Street/strip, needs 9.5:1 compression, 2800+ stall, intake, gears and headers, very rough idle.	Hyd.	Hyd.	2500 to 6400	24-602-5⁷	295TH7	295	312	243	257	.532	.501	107°
XTREME ENERGY™ Retro-Fit Hydraulic Roller Camshafts												
HYDRAULIC ROLLER – 3.91+ gear, 2500+ stall, 9.5:1 compression, aftermarket intake, headers. High performance street.	Hyd.	Hyd.	2200 to 6000	24-710-9^{5,7} Three-Bolt	XR280HR-10	280	288	230	236	.566	.544	110°
HYDRAULIC ROLLER – 3.91+ gear, 2800+ stall, 9.5:1+ compression, needs headers, rough idle.	Hyd.	Hyd.	2500 to 6200	24-711-9^{5,7} Three-Bolt	XR286HR-10	286	294	236	242	.569	.548	110°
HYDRAULIC ROLLER – 4.10 gear, 3000+ stall, 10:1 compression, very rough idle. Pro Street/bracket.	Hyd.	Hyd.	2800 to 6400	24-712-9^{5,7} Three-Bolt	XR292HR-10	292	300	242	248	.574	.551	110°

² Requires machining on cylinder heads

⁵ Requires distributor gear upgrade

⁷ Stock springs cannot be used

CHRYSLER 392 HEMI 8 CYL. 1957-1958

K-KIT	SK-KIT	CL-KIT	LIFTERS	DIST. GEAR	TIMING SET	ROCKER ARMS	PUSHRODS	VALVE SPRINGS	RETAINERS	VALVE LOCKS	VALVE SEALS	
STREET AND STRIP Hydraulic Flat Tappet Camshafts												
N/A	N/A	N/A	826-16	N/A	N/A	N/A	N/A	N/A	N/A	N/A	N/A	
N/A	N/A	N/A	826-16	N/A	N/A	N/A	N/A	N/A	N/A	N/A	N/A	
N/A	N/A	N/A	826-16	N/A	N/A	N/A	N/A	N/A	N/A	N/A	N/A	

CHRYSLER 426 HEMI 8 CYL. 1966-1971

LIFTERS	TIMING SET	ROCKER ARMS	PUSHRODS	VALVE SPRINGS	RETAINERS	VALVE LOCKS	VALVE SEALS	LASH CAPS	REV KIT	DIST. GEAR	STUD GIRDLES
STREET AND STRIP Hydraulic Flat Tappet Camshafts											
824-16	3125 3125KT	N/A	N/A	924-16 ² 26120-16 ²	741-16 795-16	610-16	500-16 ²	619-16	N/A	424	N/A
824-16	3125 3125KT	N/A	N/A	924-16 ² 26120-16 ²	741-16 795-16	610-16	500-16 ²	619-16	N/A	424	N/A
THUMPR™ Hydraulic Flat Tappet Camshafts											
824-16	3125 3125KT	N/A	N/A	924-16 ² 26120-16 ²	741-16 795-16	610-16	500-16 ²	619-16	N/A	424	N/A
824-16	3125 3125KT	N/A	N/A	924-16 ² 26120-16 ²	741-16 795-16	610-16	500-16 ²	619-16	N/A	424	N/A
824-16	3125 3125KT	N/A	N/A	924-16 ² 26120-16 ²	741-16 795-16	610-16	500-16 ²	619-16	N/A	424	N/A
XTREME ENERGY™ Retro-Fit Hydraulic Roller Camshafts											
8921-16	3125 3125KT	N/A	N/A	925-16 ² 26120-16 ²	741-16 795-16	610-16	500-16 ²	619-16	N/A	424	N/A
8921-16	3125 3125KT	N/A	N/A	925-16 ² 26120-16 ²	741-16 795-16	610-16	500-16 ²	619-16	N/A	424	N/A
8921-16	3125 3125KT	N/A	N/A	925-16 ² 26120-16 ²	741-16 795-16	610-16	500-16 ²	619-16	N/A	424	N/A

RED NUMBERS DENOTE PREMIUM OPTION

CHRYSLER 426 HEMI 8 CYL. 1966-1971 (CONTINUED)

APPLICATIONS/CAMSHAFTS	VALVE SETTING		RPM OPERATING RANGE	CAM PART #	CAM GRIND #	DURATION				VALVE LIFT		LOBE SEP. ANGLE
	IN.	EX.				ADVERTISED IN.	EX.	@ .050" IN.	EX.	W/ 1.57/1.52 ROCKER IN.	EX.	
THUMPR™ Retro-Fit Hydraulic Roller Camshafts												
HYDRAULIC ROLLER – Thumpr™ – High performance street, stock converter ok, best with 2000+ converter and gears, choppy/thumping idle.	Hyd.	Hyd.	1900 to 5600	24-600-9^{5,7}	283THR7	283	303	227	241	.536	.504	107°
HYDRAULIC ROLLER – Mutha' Thumpr™ – High performance street/strip, needs 9:1 compression, 2500+ stall, intake, gears and headers, rough idle.	Hyd.	Hyd.	2200 to 5900	24-601-9^{5,7}	291THR7	291	311	235	249	.546	.515	107°
HYDRAULIC ROLLER – Big Mutha' Thumpr™ – Street/strip, needs 9.5:1 compression, 2800+ stall, intake, gears and headers, very rough idle.	Hyd.	Hyd.	2500 to 6200	24-603-9^{5,7}	299THR7	299	319	243	257	.557	.525	107°
STREET AND STRIP Mechanical Flat Tappet Camshafts												
SOLID – Good torque and power for daily driven street engines, stock converter. Has slightly rough idle.	.020	.022	2500 to 5800	24-300-4	270S-8	270	270	235	235	.518	.502	108°
SOLID – Street/strip use. 3200+ stall or 4 speed, has rough idle.	.020	.022	3000 to 6200	24-308-4	285S-8	285	285	250	250	.557	.540	108°
DRAG RACE Mechanical Roller Camshafts												
MECHANICAL ROLLER – Super Stock race Hemi with good intake & welded heads, automatic transmission.	.026	.028	5500 to 8500	24-725-9⁵	317SSR-8	317	337	285	294	.822	.793	108°
MECHANICAL ROLLER – Super Stock race Hemi w/ latest design intake & welded heads, manual transmission.	.026	.028	5800 to 8800	24-726-9⁵	322SSR-12	322	337	292	294	.811	.793	112°
MECHANICAL ROLLER – Blown Alcohol/Pro Mod 500-550 inch, high boost blower, 45° bank block.	.026	.028	5000 to 8500	24-723-9⁵	331BAR-16	331	342	296	304	.785	.760	116°
MECHANICAL ROLLER – Blown Alcohol/Pro Mod 48° bank, journal 2.124".	.026	.028	5000 to 8500	24-721-10⁵	331BAR-16	331	342	296	304	.785	.760	116°

DODGE VIPER 10 CYL. 1992-2002

APPLICATIONS/CAMSHAFTS	VALVE SETTING		RPM OPERATING RANGE	CAM PART #	CAM GRIND #	DURATION				VALVE LIFT		LOBE SEP. ANGLE
	IN.	EX.				ADVERTISED IN.	EX.	@ .050" IN.	EX.	W/ 1.6 ROCKER IN.	EX.	
XTREME ENERGY™ Hydraulic Roller Camshafts												
HYDRAULIC ROLLER – Strong torque with good mileage, needs computer work. Head modifications necessary for related components.	Hyd.	Hyd.	1000 to 5800	97-310-10⁷ Single-Bolt	XR264HR	264	269	212	218	.520	.528	114°
HYDRAULIC ROLLER – High performance street cam, needs improved computer. Head modifications necessary for related components.	Hyd.	Hyd.	1200 to 6200	97-320-10⁷ Single-Bolt	XR270HR	269	276	218	224	.528	.536	114°

DODGE VIPER 10 CYL. 2003-PRESENT

APPLICATIONS/CAMSHAFTS	VALVE SETTING		RPM OPERATING RANGE	CAM PART #	CAM GRIND #	DURATION				VALVE LIFT		LOBE SEP. ANGLE
	IN.	EX.				ADVERTISED IN.	EX.	@ .050" IN.	EX.	W/ 1.6 ROCKER IN.	EX.	
XTREME ENERGY™ Hydraulic Roller Camshafts												
HYDRAULIC ROLLER – Strong torque with good mileage, needs computer work. Head modifications necessary for related components.	Hyd.	Hyd.	1000 to 5800	111-310-10⁷ Three-Bolt	XR264HR	264	269	212	218	.520	.528	114°
HYDRAULIC ROLLER – High performance street cam, needs improved computer. Head modifications necessary for related components.	Hyd.	Hyd.	1200 to 6200	111-320-10⁷ Three-Bolt	XR270HR	269	276	218	224	.528	.536	114°

¹ Requires screw-in studs & guide plates
² Requires machining on cylinder heads

⁵ Requires distributor gear upgrade
⁷ Stock springs cannot be used

³⁰ Other lifters & pushrod heights available
⁷⁶ Oils through pushrods

CHRYSLER 426 HEMI 8 CYL. 1966-1971 (CONTINUED)

LIFTERS	TIMING SET	ROCKER ARMS	PUSHRODS	VALVE SPRINGS	RETAINERS	VALVE LOCKS	VALVE SEALS	LASH CAPS	REV KIT	DIST. GEAR	STUD GIRDLES	
THUMPR™ Retro-Fit Hydraulic Roller Camshafts												
8921-16	3125 3125KT	N/A	N/A	925-16 ² 26120-16 ²	741-16 795-16	610-16	500-16 ²	619-16	N/A	424	N/A	
8921-16	3125 3125KT	N/A	N/A	925-16 ² 26120-16 ²	741-16 795-16	610-16	500-16 ²	619-16	N/A	424	N/A	
8921-16	3125 3125KT	N/A	N/A	925-16 ² 26120-16 ²	741-16 795-16	610-16	500-16 ²	619-16	N/A	424	N/A	
STREET AND STRIP Mechanical Flat Tappet Camshafts												
821-16 801-16 ⁷⁶	3125 3125KT	N/A	N/A	924-16 ² 26120-16 ²	741-16 795-16	610-16	500-16 ²	619-16	N/A	424	N/A	
821-16 801-16 ⁷⁶	3125 3125KT	N/A	N/A	924-16 ² 26120-16 ²	741-16 795-16	610-16	500-16 ²	619-16	N/A	424	N/A	
DRAG RACE Mechanical Roller Camshafts												
830-16 ³⁰	3125 3125KT	N/A	N/A	948-16 ² 26082-16 ²	739-16 722-16	610-16	509-16 ²	619-16	N/A	424	N/A	
830-16 ³⁰	3125 3125KT	N/A	N/A	948-16 ² 26082-16 ²	739-16 722-16	610-16	509-16 ²	619-16	N/A	424	N/A	
830-16 ³⁰	3125 3125KT	N/A	N/A	948-16 ² 26082-16 ²	739-16 722-16	610-16	509-16 ²	619-16	N/A	424	N/A	
830-16 ³⁰	3125 3125KT	N/A	N/A	948-16 ² 26082-16 ²	739-16 722-16	610-16	509-16 ²	619-16	N/A	424	N/A	

DODGE VIPER 10 CYL. 1992-2002

K-KIT	SK-KIT	CL-KIT	RP-KIT	LIFTERS	TIMING SET	ROCKER ARMS	PUSHRODS	VALVE SPRINGS	RETAINERS	VALVE LOCKS	VALVE SEALS
XTREME ENERGY™ Hydraulic Roller Camshafts											
N/A	N/A	N/A	N/A	N/A	N/A	1805-20 ¹	7693-20	924-20 ²	N/A	N/A	N/A
N/A	N/A	N/A	N/A	N/A	N/A	1805-20 ¹	7693-20	924-20 ²	N/A	N/A	N/A

DODGE VIPER 10 CYL. 2003-PRESENT

K-KIT	SK-KIT	CL-KIT	RP-KIT	LIFTERS	TIMING SET	ROCKER ARMS	PUSHRODS	VALVE SPRINGS	RETAINERS	VALVE LOCKS	VALVE SEALS
XTREME ENERGY™ Hydraulic Roller Camshafts											
N/A	N/A	N/A	N/A	N/A	N/A	1805-20 ¹	7693-20	924-20 ²	N/A	N/A	N/A
N/A	N/A	N/A	N/A	N/A	N/A	1805-20 ¹	7693-20	924-20 ²	N/A	N/A	N/A

RED NUMBERS DENOTE PREMIUM OPTION

Ford has produced some of the most powerful engines to ever come out of Detroit. With the V8 engine sizes ranging from 221-460, there is an engine size and configuration to cover just about any need or application. Ford engines do have some unique characteristics not found in any other vehicle make, so in this section we will try to familiarize you with some of the more common differences. This valve train related information should help you when choosing parts or assembling your engine.

ENGINE TYPES

Small Block, Uses "31" and "35" Prefixes

This is the standard engine in most V8 applications. It has been around since the early 1960s and remains very popular today in many configurations. The Small Block Ford engine is commonly referred to as the 5.0L engine found in the Mustang for many years. This engine has become one of the most frequently modified engines Ford has ever produced. There are a few differences in the valve train of this design, but for the most part, they are the same. One thing to remember is that the 221-302 engines have a very short deck height, requiring a short pushrod. The 351W engine, on the other hand, has a tall deck and a longer pushrod. The 1985-1995 5.0L blocks differ from the earlier blocks in that the lifter bosses are taller to accommodate the hydraulic roller lifters. The base circles of the cams for these blocks are larger because of the higher position of the lifters. These engines use either a prefix "31" (289-302) or a "35" (5.0L or 351W) camshaft, depending on the firing order.

SVO V8 Race Engine, Uses "35" Prefix

This engine is almost always found in all out racing and is a cross between the Windsor and Cleveland designs. It utilizes a Windsor type block and a Cleveland type head. The newest of the head designs is referred to as the "Yates" head.

Cleveland/Modified, Uses "32" Prefix

This design was introduced in 1969 and was available as a 351 Cleveland, a 351C Boss or a 351/400 Modified. The easiest way to tell these engines from the standard small block is by looking at the front covers. The small block/SVO engines have a cast aluminum front cover and water pump housing. The Cleveland/Modified engines have a stamped steel flat front cover. Other than a few rocker arm differences, the valve train in all of these engines is very similar.

Big Block FE, Uses "33" Prefix

Ford's FE engine family was introduced in 1958 and was available as either a 332 or a 352 version. Later, the range was expanded to include 390-428 versions. They have been out of production since the mid 70s but remain popular today. These engines utilize a shaft rocker arm system and can be most easily recognized by the fact that the intake manifold is very wide and extends part way under the valve covers. Almost all of the parts in the FE series are used only in this engine and are not interchangeable with other engine families.

Big Block "FF", Uses "34" Prefix

The engine commonly referred to as the Big Block Ford is the 429-460 and was used in light trucks and motorhomes. It is an outstanding engine for boats, bracket racing or towing and typically has a similar but larger "Cleveland" style valve train.

Modular Type Engines

The Ford "Modular Engine" was introduced in the early 1990s, with the idea of designing a new generation of engines from scratch, rather than basing them on then-current production engines. They were developed to replace all existing Ford V8 pushrod engines. The "Modular" term came about because of the many interchangeable components between the SOHC and DOHC engines, as well as the ability of Ford to machine and assemble the various engines on the same assembly lines.

The design focuses on low friction, excellent sealing and increased block stiffness. With a modern block and head design in 2 valve, 3 valve and 4 valve configurations, the engines are both versatile and powerful. They have a sophisticated overhead cam design in both single and dual overhead cam versions that utilize a roller finger follower to reduce friction, increase RPM potential and reduce maintenance.

All of the cylinder blocks have deep skirts, and nearly all of the main caps are cross bolted. SOHC engines have cast iron blocks; DOHC engines have aluminum blocks (2003-04 Cobra has an iron block). All cylinder heads are aluminum, with very long head bolts to reduce distortion of the cylinder bores and improve sealing. The newer design also allows the accessories to be rigidly mounted directly to the block.

4.6L & 5.4L 2 Valve SOHC, Uses "102" Prefix

The 4.6L version of this engine first came out in the 1991 Lincoln Town Car and later was installed in the Crown Victoria, Grand Marquis, Thunderbird, and Cougar. In 1997 the 5.4L version of the 2 valve SOHC engine was introduced. This engine, known as the "Triton" truck engine, has numerous parts that are interchangeable with the modular car engines. However, not all are identical since the truck engines are built to handle more severe duty.

4.6L & 5.4L 3 Valve SOHC, Uses "127" Prefix

The 4.6L SOHC 3 Valve engine is available in today's Mustangs and trucks. The engine features variable cam timing, allowing the valves to open and close earlier or later as needed for optimum power. This technology was first introduced in 2004 in the 5.4L 3 Valve DOHC engines. This engine, also known as the "Triton", is primarily in the F-150 trucks.

4.6L & 5.4L 4 Valve DOHC, Uses "106" Prefix

This engine showed up first in the 1993 Lincoln Mark VIII and later in the front-wheel drive Continental. It has since been put in performance cars, such as the Mustang Cobra/GT500.

5.0L Coyote DOHC, Uses "191" Prefix

Designed for the Mustang GT, this 5.0L engine produces the power of its much larger competitors. It features an all aluminum block, high flowing heads, cross-flow cooling, and Twin independent Variable Cam Timing (TiVCT). Other variations of the Coyote were created for use in the F-150 truck, Boss 302 and the Australian Falcon.



CAMSHAFTS FORD

GENERAL TIPS

FIRING ORDER, SMALL BLOCK & SVO

This is one of the most common questions asked by Ford customers. The firing order for the early 221-302 engines and the early 5.0 engines is 1-5-4-2-6-3-7-8. This is the firing order for all prefix "31" cams and is the standard replacement cam for all early engines. Most of the later 5.0L engine and 351 engines are designed to use the 1-3-7-2-6-5-4-8 firing order. This is the firing order for all prefix "35" cams, and cams ordered for these engines should use this prefix. However, non H.O. 302 5.0 engines use the early 1-5-4-2-6-3-7-8 firing order and require a custom grind from COMP Cams®. Other than the firing order, the cams are identical. By changing the spark plug wiring at the distributor these cams can be interchanged (only on carbureted applications or those using a FAST™ EFI system). ***EXCEPT IN MASS AIR VEHICLES***

CAMSHAFT DOWEL PIN/ FUEL PUMP ECCENTRIC

Two different length dowel pins were used in the front of the cams in 221-351W engines. In 1972 and earlier engines, a longer (1.375") dowel pin was used so that it would extend through the one-piece fuel pump eccentric used on these engines. The 1973 and later engines utilized a two-piece fuel pump eccentric which required a shorter (1.125") dowel pin. If no eccentric is used, a thicker than standard retaining washer must be used to make up for the thickness of the eccentric. The cam gear **MUST** be pulled tightly against the snout of the cam. If the gear is not tight against the step at the front of the cam, the cam bolt will come loose, and engine failure is sure to occur.

Dowel pin failure is fairly common in Small Block Ford engines. This is almost never the result of a defective or soft dowel pin. It is most often caused by the bolt in the center of the cam loosening and allowing the dowel pin to be loaded and shear. The center bolt should always be torqued to the manufacturer's specifications and a suitable thread lock used to prevent the bolt from backing out.

CAM PHASERS

Cam phasers are specially designed, computer-controlled cam gears for all 2005 and newer, 3 Valve Ford Modular engines that have the ability to adjust camshaft position up to 60° while the engine is running. This helps to increase the engine's fuel efficiency. Another benefit is that the cam phasers allow the camshafts to always be in the best position for maximum power, regardless of the engine's RPM. The engine makes more torque and horsepower and extends the high RPM power-band by an additional 800-1000 RPM. But because there is such a wide range of movement, only fairly small cam profiles can be used without causing piston to valve clearance issues.

COMP Cams® has developed the COMP Cams® Phaser Limiter Kit to eliminate this problem. These limiter plates replace the factory back-plate on the cam phaser. They have posts which extend into the cam gear's control chambers, limiting their movement to no more than 20°. This allows you to install bigger, more powerful camshafts with safe piston to valve clearances. While keeping up to 20° of movement available, all of the wide-open throttle benefits of the cam phasing is retained, since the normal retard the cams see at wide-open throttle is only around 9°. You **MUST** reprogram your engine's computer for it to operate properly after installing the cam phaser limiters.

CAMSHAFT RETENTION BOLT

Most V8 Ford engines used a 3/8" bolt to secure the upper cam gear to the cam. Almost all racing engines use a 7/16" bolt for this application. Be sure to check the compatibility of the bolt to the cam, as a 3/8" bolt in a 7/16" cam will almost certainly result in catastrophic engine failure. Most of the COMP Cams® racing roller cams will come with the 7/16" hole in the cam.



FORD 2000-2300 OHC 4 CYL. (4 JOURNAL) 1971-1991

APPLICATIONS/CAMSHAFTS	VALVE SETTING		RPM OPERATING RANGE	CAM PART #	CAM GRIND #	DURATION				VALVE LIFT		LOBE SEP. ANGLE
	IN.	EX.				ADVERTISED IN.	EX.	@ .050" IN.	EX.	IN.	EX.	
HIGH ENERGY™ Hydraulic Flat Tappet Camshafts												
HYDRAULIC – Excellent torque and good mileage. Perfect cam for OEM replacement.	Hyd.	Hyd.	800 to 4800	70-115-6	240H	247	247	201	201	.400	.400	110°
HYDRAULIC – Power and mileage increase in low to mid RPM range. Great for highway driving.	Hyd.	Hyd.	1000 to 5000	70-119-6	252H	256	256	210	210	.410	.410	110°
HYDRAULIC – Good for towing in trucks and sedans. Excellent torque. Smooth idle.	Hyd.	Hyd.	1200 to 5200	70-123-6	260H	264	264	218	218	.420	.420	110°
MAGNUM Hydraulic Flat Tappet Camshafts												
HYDRAULIC – Good all around street performance. Can be used in daily driver. Mid-range power.	Hyd.	Hyd.	1500 to 5500	70-127-6	268H	272	272	226	226	.440	.440	110°
HYDRAULIC – Great power in mid-range and high RPM. Performance cam for street use.	Hyd.	Hyd.	1800 to 5800	70-131-6	280H	280	280	236	236	.460	.460	110°
OVAL TRACK Mechanical Flat Tappet Camshafts												
SOLID – Aftermarket intake and headers needed. 500 CFM carb., 11:1+ compression.	.010	.010	3500 to 7400	70-202-6⁵³	294S	300	300	270	270	.503	.503	112°
SOLID – Ported cylinder head, longer valves. 12:1+ compression.	.010	.010	3800 to 7800	70-204-6⁵⁴	300S	315	315	285	285	.638	.638	110°

FORD ZETEC 2.0L DOHC 4 CYL. 1995-1997 AND 2000-2003

APPLICATIONS/CAMSHAFTS	VALVE SETTING		RPM OPERATING RANGE	CAM PART #	CAM GRIND #	DURATION				VALVE LIFT		LOBE SEP. ANGLE
	IN.	EX.				ADVERTISED IN.	EX.	@ .050" IN.	EX.	IN.	EX.	
XR SERIES Solid Direct Acting Camshafts (CUSTOM SETS AVAILABLE)												
SERIOUS STREET/RACE – Pulls strong through RPM range. Responds well to bolt-ons.	.010	.010	1400 to 6000	108100⁸⁴	Z273	273	273	220	220	.381	.381	112° 112°
SEVERE STREET/COMPETITION – Strong improvement in torque and HP from mid-range and up. Responds well to cold air intakes and exhaust upgrades.	.010	.010	1800 to 7000	108200⁸⁴	Z281	281	281	228	228	.381	.381	112° 112°
COMPETITION/PRO RACE – High RPM power. Maximize HP gains w/ aftermarket intake & exhaust upgrades.	.010	.010	2200 to 7400	108300⁸⁴	Z289	289	289	236	236	.381	.381	112° 112°

FORD 144-250 C.I. 6 CYL. 1960-1983 (7.808" DECK)

APPLICATIONS/CAMSHAFTS	VALVE SETTING		RPM OPERATING RANGE	CAM PART #	CAM GRIND #	DURATION				VALVE LIFT		LOBE SEP. ANGLE
	IN.	EX.				ADVERTISED IN.	EX.	@ .050" IN.	EX.	W/ 1.5 ROCKER IN.	EX.	
HIGH ENERGY™ Hydraulic Flat Tappet Camshafts												
HYDRAULIC – Best cam for low RPM torque or for use in 200c.i. and smaller engines. Economy and smooth idle.	Hyd.	Hyd.	500 to 4500	65-235-4	252H	252	252	206	206	.425	.425	110°
HYDRAULIC – Good for towing in 200-250c.i., mid-range torque and power. Smooth idle.	Hyd.	Hyd.	1000 to 5000	65-236-4	260H	260	260	212	212	.440	.440	110°

⁷ Stock springs cannot be used

⁸ Fits only certain years

⁵³ These specs are measured w/ a stock length valve & .010" lash between the cam & follower

⁵⁴ These specs are measured w/ a .060" longer than stock valve & .010" lash between cam & follower

FORD 2000-2300 OHC 4 CYL. (4 JOURNAL) 1971-1991

K-KIT	SK-KIT	CL-KIT	RP-KIT	LIFTERS	TIMING SET	ROCKER ARMS	PUSHRODS	VALVE SPRINGS	RETAINERS	VALVE LOCKS	VALVE SEALS	
HIGH ENERGY™ Hydraulic Flat Tappet Camshafts												
N/A	N/A	CL70-115-6	N/A	846-8	N/A	1270-8	N/A	N/A	N/A	N/A	N/A	
N/A	N/A	CL70-119-6	N/A	846-8	N/A	1270-8	N/A	N/A	N/A	N/A	N/A	
N/A	N/A	CL70-123-6	N/A	846-8	N/A	1270-8	N/A	N/A	N/A	N/A	N/A	
MAGNUM Hydraulic Flat Tappet Camshafts												
N/A	N/A	CL70-127-6 ⁷	N/A	846-8	N/A	1270-8	N/A	N/A	N/A	N/A	N/A	
N/A	N/A	CL70-131-6 ⁷	N/A	846-8	N/A	1270-8	N/A	N/A	N/A	N/A	N/A	
OVAL TRACK Mechanical Flat Tappet Camshafts												
N/A	N/A	N/A	N/A	N/A	N/A	1270-8	N/A	N/A	N/A	N/A	N/A	
N/A	N/A	N/A	N/A	N/A	N/A	1270-8	N/A	N/A	N/A	N/A	N/A	

FORD ZETEC 2.0L DOHC 4 CYL. 1995-1997 AND 2000-2003

K-KIT	SK-KIT	CL-KIT	RP-KIT	LIFTERS	TIMING SET	ROCKER ARMS	PUSHRODS	VALVE SPRINGS	RETAINERS	VALVE LOCKS	VALVE SEALS	
XR SERIES Solid Direct Acting Camshafts (CUSTOM SETS AVAILABLE)												
N/A	N/A	N/A	N/A	N/A	N/A	N/A	N/A	N/A	N/A	N/A	N/A	
N/A	N/A	N/A	N/A	N/A	N/A	N/A	N/A	N/A	N/A	N/A	N/A	
N/A	N/A	N/A	N/A	N/A	N/A	N/A	N/A	N/A	N/A	N/A	N/A	

FORD 144-250 C.I. 6 CYL. 1960-1983 (7.808" DECK)

K-KIT	SK-KIT	CL-KIT	RP-KIT	LIFTERS	TIMING SET	ROCKER ARMS	PUSHRODS	VALVE SPRINGS	RETAINERS	VALVE LOCKS	VALVE SEALS	
HIGH ENERGY™ Hydraulic Flat Tappet Camshafts												
K65-235-4	SK65-235-4	CL65-235-4	N/A	834-12	3223 ⁸	N/A	7865-12	902-12	N/A	601-12	502-12	
K65-236-4	SK65-236-4	CL65-236-4	N/A	834-12	3223 ⁸	N/A	7865-12	902-12	N/A	601-12	502-12	

⁸⁴ Will not work in 1998-99 models



FORD 240-300 C.I. 6 CYL. 1965-1996 (10" DECK)

APPLICATIONS/CAMSHAFTS	VALVE SETTING		RPM OPERATING RANGE	CAM PART #	CAM GRIND #	DURATION				VALVE LIFT		LOBE SEP. ANGLE
	IN.	EX.				ADVERTISED IN.	EX.	@ .050" IN.	EX.	W/ 1.6 ROCKER IN.	EX.	
HIGH ENERGY™ Hydraulic Flat Tappet Camshafts												
HYDRAULIC – Good torque and mileage for 240-300. Excellent throttle response.	Hyd.	Hyd.	500 to 4500	66-236-4	252H	252	252	206	206	.433	.433	110°
HYDRAULIC – Excellent torque and power for towing in 300c.i. Smooth idle.	Hyd.	Hyd.	1000 to 5000	66-237-4	260H	260	260	212	212	.447	.447	110°
HYDRAULIC – Moderate performance camshaft for 300c.i. Strong in mid-range RPM. Noticeable idle.	Hyd.	Hyd.	1200 to 5200	66-248-4	268H	268	268	218	218	.456	.456	110°

FORD 2600-2800 OHV 6 CYL. 1972-1980 PASSENGER CARS

APPLICATIONS/CAMSHAFTS	VALVE SETTING		RPM OPERATING RANGE	CAM PART #	CAM GRIND #	DURATION				VALVE LIFT		LOBE SEP. ANGLE
	IN.	EX.				ADVERTISED IN.	EX.	@ .050" IN.	EX.	W/ 1.46 ROCKER IN.	EX.	
HIGH ENERGY™ Mechanical Flat Tappet Camshafts												
SOLID – Good for OEM replacement or rebuild. Low RPM torque with good economy. Very smooth idle.	.010	.012	500 to 4500	36-101-4	244S	244	244	200	200	.388	.388	108°
SOLID – Power increase in low to mid RPM range. Economy with performance. Smooth idle.	.010	.012	800 to 4800	36-240-4	252S	252	252	210	210	.423	.423	110°
SOLID – Moderate performance camshaft. Strong in mid-range RPM. Noticeable idle.	.010	.012	1200 to 5200	36-241-4	264S	264	264	220	220	.428	.428	110°

FORD 2800 OHV 6 CYL. 1983-1986 BRONCO II/RANGER

APPLICATIONS/CAMSHAFTS	VALVE SETTING		RPM OPERATING RANGE	CAM PART #	CAM GRIND #	DURATION				VALVE LIFT		LOBE SEP. ANGLE
	IN.	EX.				ADVERTISED IN.	EX.	@ .050" IN.	EX.	W/ 1.46 ROCKER IN.	EX.	
HIGH ENERGY™ Mechanical Flat Tappet Camshafts												
SOLID – Good cam for OEM replacement or rebuild. Low RPM torque w/ good economy. Very smooth idle.	.010	.012	500 to 4500	38-101-4	244S	244	244	200	200	.388	.388	108°
SOLID – Performance with economy, power increase in low to mid RPM range. Smooth idle.	.010	.012	800 to 4800	38-240-4	252S	252	252	210	210	.423	.423	110°
SOLID – Moderate performance camshaft. Strong in mid-range RPM. Noticeable idle.	.010	.012	1200 to 5200	38-241-4	264S	264	264	220	220	.428	.428	110°

FORD 3.8L & 4.2L 6 CYL. 1989-2004

APPLICATIONS/CAMSHAFTS	VALVE SETTING		RPM OPERATING RANGE	CAM PART #	CAM GRIND #	DURATION				VALVE LIFT		LOBE SEP. ANGLE
	IN.	EX.				ADVERTISED IN.	EX.	@ .050" IN.	EX.	W/ 1.6 ROCKER IN.	EX.	
XTREME ENERGY™ Hydraulic Roller Camshafts												
HYDRAULIC ROLLER – Excellent upgrade for factory cam. Strong torque, mid-range and power.	Hyd.	Hyd.	1000 to 5000	44-700-9	255HR112	255	263	200	208	.480	.480	112°
HYDRAULIC ROLLER – Excellent upgrade for Super Coupe, strong torque.	Hyd.	Hyd.	1200 to 5800	44-701-9	259HR115	259	271	204	216	.480	.480	115°
HYDRAULIC ROLLER – Mild performance, needs spring upgrade & may require computer modifications.	Hyd.	Hyd.	1500 to 5800	44-702-9	268HR112	265	273	210	218	.500	.500	112°
HYDRAULIC ROLLER – Serious street cam for Super Coupe or nitrous applications, needs spring upgrade and requires custom tuning.	Hyd.	Hyd.	1500 to 6000	44-703-9	265HR115	265	281	210	226	.500	.500	115°
HYDRAULIC ROLLER – Max strip/street cam, requires spring upgrade and custom tuning.	Hyd.	Hyd.	1800 to 6200	44-704-9	273HR112	273	281	218	226	.500	.500	112°

⁷ Stock springs cannot be used

⁸³ Requires extensive machining to heads for 1995 & older models. '95 & earlier models, use #942-12 w/ OEM retainers & locks.

FORD 240-300 C.I. 6 CYL. 1965-1996 (10" DECK)

K-KIT	SK-KIT	CL-KIT	RP-KIT	LIFTERS	TIMING SET	ROCKER ARMS	PUSHRODS	VALVE SPRINGS	RETAINERS	VALVE LOCKS	VALVE SEALS
HIGH ENERGY™ Hydraulic Flat Tappet Camshafts											
K66-236-4	SK66-236-4	CL66-236-4	N/A	832-12	3224 3141	1266-12	7866-12	903-12	N/A	901-12	502-12
K66-237-4	SK66-237-4	CL66-237-4	N/A	832-12	3224 3141	1266-12	7866-12	903-12	N/A	901-12	502-12
K66-248-4	SK66-248-4	CL66-248-4 ⁷	N/A	832-12	3224 3141	1266-12	7866-12	903-12	N/A	901-12	502-12

FORD 2600-2800 OHV 6 CYL. 1972-1980 PASSENGER CARS

K-KIT	SK-KIT	CL-KIT	RP-KIT	LIFTERS	TIMING SET	ROCKER ARMS	PUSHRODS	VALVE SPRINGS	RETAINERS	VALVE LOCKS	VALVE SEALS
HIGH ENERGY™ Mechanical Flat Tappet Camshafts											
N/A	SK36-101-4	CL36-101-4	N/A	835-12	3236	1236-12	7836-12	906-12	N/A	N/A	N/A
N/A	SK36-240-4	CL36-240-4	N/A	835-12	3236	1236-12	7836-12	906-12	N/A	N/A	N/A
N/A	SK36-241-4	CL36-241-4	N/A	835-12	3236	1236-12	7836-12	906-12	N/A	N/A	N/A

FORD 2800 OHV 6 CYL. 1983-1986 BRONCO II/RANGER

K-KIT	SK-KIT	CL-KIT	RP-KIT	LIFTERS	TIMING SET	ROCKER ARMS	PUSHRODS	VALVE SPRINGS	RETAINERS	VALVE LOCKS	VALVE SEALS
HIGH ENERGY™ Mechanical Flat Tappet Camshafts											
N/A	SK38-101-4	CL38-101-4	N/A	835-12	3236	1236-12	7836-12	906-12	N/A	N/A	N/A
N/A	SK38-240-4	CL38-240-4	N/A	835-12	3236	1236-12	7836-12	906-12	N/A	N/A	N/A
N/A	SK38-241-4	CL38-241-4	N/A	835-12	3236	1236-12	7836-12	906-12	N/A	N/A	N/A

FORD 3.8L & 4.2L 6 CYL. 1989-2004

K-KIT	SK-KIT	CL-KIT	RP-KIT	LIFTERS	TIMING SET	ROCKER ARMS	PUSHRODS	VALVE SPRINGS	RETAINERS	VALVE LOCKS	VALVE SEALS
XTREME ENERGY™ Hydraulic Roller Camshafts											
N/A	N/A	N/A	N/A	851-12	N/A	1619-12	7635-12	26918-12 ⁸³	786-12	N/A	N/A
N/A	N/A	N/A	N/A	851-12	N/A	1619-12	7635-12	26918-12 ⁸³	786-12	N/A	N/A
N/A	N/A	N/A	N/A	851-12	N/A	1619-12	7635-12	26918-12 ⁸³	786-12	N/A	N/A
N/A	N/A	N/A	N/A	851-12	N/A	1619-12	7635-12	26918-12 ⁸³	786-12	N/A	N/A
N/A	N/A	N/A	N/A	851-12	N/A	1619-12	7635-12	26918-12 ⁸³	786-12	N/A	N/A

RED NUMBERS DENOTE PREMIUM OPTION

FORD 4.0L 6 CYL. 1990-2001

APPLICATIONS/CAMSHAFTS	VALVE SETTING		RPM OPERATING RANGE	CAM PART #	CAM GRIND #	DURATION				VALVE LIFT		LOBE SEP. ANGLE
	IN.	EX.				ADVERTISED IN.	EX.	@ .050" IN.	EX.	W/ 1.5 ROCKER IN.	EX.	
HIGH ENERGY™ Hydraulic Roller Camshafts												
HYDRAULIC ROLLER – Good upgrade for factory cam in Explorers & Rangers. Good torque & mileage. Great for towing.	Hyd.	Hyd.	800 to 4800	49-410-8⁹⁸	256HR	256	266	200	210	.465	.500	112°
HYDRAULIC ROLLER – Good in Explorers & Rangers with aftermarket chip. Strong torque and mid-range.	Hyd.	Hyd.	1200 to 5200	49-422-8⁹⁸	270HR	270	284	215	224	.500	.500	112°

FLATHEAD FORD (2 GEAR) 239, 255 C.I. 8 CYL. 1949-1953

APPLICATIONS/CAMSHAFTS	VALVE SETTING		RPM OPERATING RANGE	CAM PART #	CAM GRIND #	DURATION				VALVE LIFT		LOBE SEP. ANGLE
	IN.	EX.				ADVERTISED IN.	EX.	@ .050" IN.	EX.	IN.	EX.	
CLASSIC THUMPR™ Mechanical Flat Tappet Camshafts												
SOLID – Classic Thumpr™ – Street performance, choppy/thumping idle.	.012	.014	1800-3600	41-600-7	279TS7	267	299	227	241	.354	.350	107°
SOLID – Classic Mutha' Thumpr™ – Performance street/strip, needs higher compression and aftermarket heads, rough idle.	.012	.014	2000-4000	41-601-7	287TS7	275	307	235	249	.368	.364	107°
SOLID – Classic Big Mutha' Thumpr™ – Street/strip, engine modification mandatory, aftermarket heads, very rough idle.	.012	.014	2200-4200	41-602-7	295TS7	283	315	243	257	.382	.378	107°

FORD Y-BLOCK 292, 312 C.I. 8 CYL. 1955-1962

APPLICATIONS/CAMSHAFTS	VALVE SETTING		RPM OPERATING RANGE	CAM PART #	CAM GRIND #	DURATION				VALVE LIFT		LOBE SEP. ANGLE
	IN.	EX.				ADVERTISED IN.	EX.	@ .050" IN.	EX.	W/ 1.6 ROCKER IN.	EX.	
CLASSIC THUMPR™ Mechanical Flat Tappet Camshafts												
SOLID – Classic Thumpr™ – Performance street with good bottom end. Choppy/thumping idle.	.012	.014	2000-5800	37-600-5	268TS7	268	287	231	245	.479	.470	107°
SOLID – Classic Mutha' Thumpr™ – High performance street/strip, gears and headers, rough idle.	.012	.014	2200-5500	37-601-5	276TS7	276	295	239	253	.489	.480	107°
SOLID – Classic Big Mutha' Thumpr™ – Street/strip, needs higher compression, gears & headers, very rough idle.	.012	.014	2500-5700	37-602-5	284TS7	284	303	247	261	.500	.491	107°

FORD 4.6L & 5.4L SOHC MODULAR 2 VALVE 8 CYL. 1991-PRESENT

APPLICATIONS/CAMSHAFTS	VALVE SETTING		RPM OPERATING RANGE	CAM PART #	CAM GRIND #	DURATION				VALVE LIFT		LOBE SEP. ANGLE
	IN.	EX.				ADVERTISED IN.	EX.	@ .050" IN.	EX.	W/ 1.825 ROCKER IN.	EX.	
XTREME ENERGY™ Hydraulic Roller Swinging Follower Camshafts												
SOHC – Excellent upgrade from stock cam. Improved torque and power. Works with stock computer, best with custom tuning. Smooth idle.	Hyd.	Hyd.	1200 to 5200	102100*	XE262H	262	270	224	232	.500	.500	114°
SOHC – Mild street performance, 3.23-3.55 gears. Good torque and power. Noticeable idle. Requires custom tuning.	Hyd.	Hyd.	1600 to 5600	102200*	XE268H	268	274	230	236	.500	.500	114°
SOHC – Hot street, 3.55-3.73 gears, 2000+ stall. Requires custom tuning. Rough idle.	Hyd.	Hyd.	2000 to 6000	102300*	XE274H	274	278	236	240	.500	.500	114°

* Requires aftermarket valve springs/retainers.

⁹⁸ Will not work with stock length pushrods

FORD 4.0L 6 CYL. 1990-2001

K-KIT	SK-KIT	CL-KIT	RP-KIT	LIFTERS	TIMING SET	ROCKER ARMS	PUSHRODS	VALVE SPRINGS	RETAINERS	VALVE LOCKS	VALVE SEALS	
HIGH ENERGY™ Hydraulic Roller Camshafts												
N/A	N/A	N/A	N/A	N/A	N/A	N/A	N/A	988-12	N/A	N/A	N/A	
N/A	N/A	N/A	N/A	N/A	N/A	N/A	N/A	988-12	N/A	N/A	N/A	

FLATHEAD FORD (2 GEAR) 239, 255 C.I. 8 CYL. 1949-1953

K-KIT	SK-KIT	CL-KIT	LIFTERS	DIST. GEAR	TIMING SET	ROCKER ARMS	PUSHRODS	VALVE SPRINGS	RETAINERS	VALVE LOCKS	VALVE SEALS	
CLASSIC THUMPR™ Mechanical Flat Tappet Camshafts												
N/A	N/A	N/A	811FH-16	N/A	N/A	N/A	N/A	N/A	N/A	N/A	N/A	
N/A	N/A	N/A	811FH-16	N/A	N/A	N/A	N/A	N/A	N/A	N/A	N/A	
N/A	N/A	N/A	811FH-16	N/A	N/A	N/A	N/A	N/A	N/A	N/A	N/A	

FORD Y-BLOCK 292, 312 C.I. 8 CYL. 1955-1962

K-KIT	SK-KIT	CL-KIT	LIFTERS	DIST. GEAR	TIMING SET	ROCKER ARMS	PUSHRODS	VALVE SPRINGS	RETAINERS	VALVE LOCKS	VALVE SEALS	
CLASSIC THUMPR™ Mechanical Flat Tappet Camshafts												
N/A	N/A	N/A	2931-16	N/A	N/A	N/A	N/A	N/A	N/A	N/A	N/A	
N/A	N/A	N/A	2931-16	N/A	N/A	N/A	N/A	N/A	N/A	N/A	N/A	
N/A	N/A	N/A	2931-16	N/A	N/A	N/A	N/A	N/A	N/A	N/A	N/A	

FORD 4.6L & 5.4L SOHC MODULAR 2 VALVE 8 CYL. 1991-PRESENT

K-KIT	SK-KIT	CL-KIT	RP-KIT	LIFTERS	CAM GEAR SET	ROCKER ARMS	PUSHRODS	VALVE SPRINGS	RETAINERS	VALVE LOCKS	VALVE SEALS	
XTREME ENERGY™ Hydraulic Roller Swinging Follower Camshafts												
N/A	N/A	N/A	N/A	N/A	10254	N/A	N/A	26113-16 26125-16	792-16 791-16	N/A	N/A	
N/A	N/A	N/A	N/A	N/A	10254	N/A	N/A	26113-16 26125-16	792-16 791-16	N/A	N/A	
N/A	N/A	N/A	N/A	N/A	10254	N/A	N/A	26113-16 26125-16	792-16 791-16	N/A	N/A	

RED NUMBERS DENOTE PREMIUM OPTION

FORD 4.6L & 5.4L SOHC MODULAR 2 VALVE 8 CYL. 1991-PRESENT (CONTINUED)

APPLICATIONS/CAMSHAFTS	VALVE SETTING		RPM OPERATING RANGE	CAM PART #	CAM GRIND #	DURATION				VALVE LIFT		LOBE SEP. ANGLE
	IN.	EX.				IN.	EX.	IN.	EX.	W/ 1.825 ROCKER	EX.	
XTREME ENERGY™ Hydraulic Roller Swinging Follower Camshafts												
1999-Up Performance Improvement Heads												
SOHC – Excellent torque. Better low and mid-range torque with more power. Will work with stock computer, best with custom tuning.	Hyd.	Hyd.	1400 to 5400	102500*	XE262AH	262	266	226	230	.550	.550	113°
SOHC – Hot street cam, needs higher gear ratio. 2000+ stall. Intake, exhaust, computer upgrade recommended. Noticeable idle. Requires custom tuning	Hyd.	Hyd.	1800 to 5800	102600*	XE270AH	270	274	234	238	.550	.550	113°
SOHC – Street/strip, needs higher gear ratio, 2400+ stall. Intake, exhaust, requires custom tuning. Rough idle.	Hyd.	Hyd.	2200 to 6200	102700*	XE278AH	278	282	242	246	.550	.550	113°
XTREME ENERGY™ Blower Hydraulic Roller Swinging Follower Camshafts												
1999-Up Performance Improvement Heads												
SOHC – Good torque with powerful mid-range when using a blower. Requires custom tuning.	Hyd.	Hyd.	1600 to 5600	102560*	XE262BH-16	262	266	226	230	.550	.550	116°
TRI-POWER XTREME™ Hydraulic Roller Swinging Follower Camshafts												
SOHC – Optimized fuel mileage with good torque and horsepower. Requires tuning.	Hyd.	Hyd.	800 to 4800	102525*	TPX248HR-16	247	257	212	222	.484	.475	116°
SOHC – Exceptional torque with good horsepower and good fuel economy. Requires tuning.	Hyd.	Hyd.	1000 to 5000	102530*	TPX254HR-15	253	261	218	226	.484	.475	115°
SOHC – Optimized combination for power and torque with acceptable fuel economy for daily driver or highway cruiser. Requires tuning.	Hyd.	Hyd.	1200 to 5200	102535*	TPX262HR-14	261	267	224	230	.495	.495	114°

* Requires aftermarket valve springs/retainers.

FORD 4.6L & 5.4L SOHC MODULAR 3 VALVE 8 CYL. 2004-PRESENT

APPLICATIONS/CAMSHAFTS	VALVE SETTING		RPM OPERATING RANGE	CAM PART #	CAM GRIND #	DURATION				VALVE LIFT		LOBE SEP. ANGLE
	IN.	EX.				IN.	EX.	IN.	EX.	W/ 1.825 ROCKER	EX.	
XFI™ NSR (NO SPRINGS REQUIRED) Hydraulic Roller Swinging Follower Camshafts												
SOHC – Great upgrade for stock engine. Solid power gains above 4700 RPM, compatible with stock springs. Works with stock tune.	Hyd.	Hyd.	750 to 6200	127050	XE253LH-14	253	270	214	227	.450	.450	114°
SOHC – Solid power gains above 4900 RPM, compatible with stock springs. Works with stock tune. Best with 3.73 gear & 2500 stall. Great idle.	Hyd.	Hyd.	750 to 6400	127200	XE261LH-15.5	261	278	222	235	.450	.450	115.5°
XFI™ NSR (NO SPRINGS REQUIRED) BLOWER Hydraulic Roller Swinging Follower Camshafts												
SOHC – Excellent mid-range cam for bolt-on blowers with stock boost levels. Great power gains above 4700 RPM, compatible with stock springs. Best with stock gears. Works with stock tune.	Hyd.	Hyd.	750 to 6200	127055	XE253LH-15	253	274	214	231	.450	.450	115°
SOHC – Mid to upper range for bolt-on blowers running higher boost psi. Major power gains above 4900 RPM, compatible with stock springs. Best with 3.73+ gears & 2500 stall. Great idle. Works with stock tune.	Hyd.	Hyd.	750 to 6400	127205	XE261LH-16.5	261	282	222	239	.450	.450	116.5°

FORD 4.6L & 5.4L SOHC MODULAR 2 VALVE 8 CYL. 1991-PRESENT (CONTINUED)

K-KIT	SK-KIT	CL-KIT	RP-KIT	LIFTERS	CAM GEAR SET	ROCKER ARMS	PUSHRODS	VALVE SPRINGS	RETAINERS	VALVE LOCKS	VALVE SEALS
XTREME ENERGY™ Hydraulic Roller Swinging Follower Camshafts											
N/A	N/A	N/A	N/A	N/A	10254	N/A	N/A	26113-16 26125-16	792-16 791-16	N/A	N/A
N/A	N/A	N/A	N/A	N/A	10254	N/A	N/A	26113-16 26125-16	792-16 791-16	N/A	N/A
N/A	N/A	N/A	N/A	N/A	10254	N/A	N/A	26113-16 26125-16	792-16 791-16	N/A	N/A
XTREME ENERGY™ Blower Hydraulic Roller Swinging Follower Camshafts											
N/A	N/A	N/A	N/A	N/A	10254	N/A	N/A	26113-16	792-16 791-16	N/A	N/A
TRI-POWER XTREME™ Hydraulic Roller Swinging Follower Camshafts											
N/A	N/A	N/A	N/A	N/A	10254	N/A	N/A	26113-16 26125-16	792-16 791-16	N/A	N/A
N/A	N/A	N/A	N/A	N/A	10254	N/A	N/A	26113-16 26125-16	792-16 791-16	N/A	N/A
N/A	N/A	N/A	N/A	N/A	10254	N/A	N/A	26113-16 26125-16	792-16 791-16	N/A	N/A

FORD 4.6L & 5.4L SOHC MODULAR 3 VALVE 8 CYL. 2004-PRESENT

K-KIT	SK-KIT	CL-KIT	RP-KIT	LIFTERS	PHASER LIMITER KIT	ROCKER ARMS	PUSHRODS	VALVE SPRINGS	RETAINERS	VALVE LOCKS	VALVE SEALS
XFI™ NSR (NO SPRINGS REQUIRED) Hydraulic Roller Swinging Follower Camshafts											
N/A	N/A	N/A	N/A	N/A	5449	N/A	N/A	N/A	N/A	N/A	N/A
N/A	N/A	N/A	N/A	N/A	5449	N/A	N/A	N/A	N/A	N/A	N/A
XFI™ NSR (NO SPRINGS REQUIRED) BLOWER Hydraulic Roller Swinging Follower Camshafts											
N/A	N/A	N/A	N/A	N/A	5449	N/A	N/A	N/A	N/A	N/A	N/A
N/A	N/A	N/A	N/A	N/A	5449	N/A	N/A	N/A	N/A	N/A	N/A

RED NUMBERS DENOTE PREMIUM OPTION

FORD 4.6L & 5.4L SOHC MODULAR 3 VALVE 8 CYL. 2004-PRESENT (CONTINUED)

APPLICATIONS/CAMSHAFTS	VALVE SETTING		RPM OPERATING RANGE	CAM PART #	CAM GRIND #	DURATION				VALVE LIFT		LOBE SEP. ANGLE
	IN.	EX.				IN.	EX.	IN.	EX.	IN.	EX.	
THUMPR™ NSR (NO SPRINGS REQUIRED) Hydraulic Roller Swinging Follower Camshafts												
SOHC – Thumpr™ – Great idle with excellent power. Good mid-range torque and power gains above 4500 RPM. Compatible with stock valve springs, converter and gears; requires cam phaser upgrade and custom tuning.	Hyd.	Hyd.	750 to 6400	127010*	TH265LL-9	265	298	226	246	.450	.450	109°
SOHC – Mutha' Thumpr™ – Very rough idle, biggest cam for stock heads. Great power above 4900 RPM. Compatible with stock valve springs, benefits from converter and gears, requires cam phaser upgrade and custom tuning.	Hyd.	Hyd.	750 to 6600	127020*	MT273LL-9	273	306	234	254	.450	.450	109°
SOHC – Big Mutha' Thumpr™ – Extremely rough idle, needs stroker motor and/or ported heads. Major hp gains to 6800 RPM. Best with 3.73+ gears and 2500 stall. Compatible with stock valve springs, requires cam phaser upgrade.	Hyd.	Hyd.	750 to 6800	127030*	BT281LL-9	281	314	242	262	.450	.450	109°
XFI™ VSR (VALVE SPRINGS REQUIRED) Hydraulic Roller Swinging Follower Camshafts												
SOHC – Great upgrade over stock. Solid power gains above 4400 RPM, requires spring upgrade. Stock gears & converter OK. Recommend custom tuning.	Hyd.	Hyd.	850 to 6200	127100	XE253H-14	253	270	214	227	.480	.470	114°
SOHC – Serious street cam, noticeable idle. Solid power gains above 4600 RPM, requires spring upgrade. Works with tuners, recommend custom tuning. Best with 3.90 gears and 3000 stall.	Hyd.	Hyd.	950 to 6400	127300	XE261H-15.5	261	278	222	235	.490	.480	115.5°
XFI™ VSR (VALVE SPRINGS REQUIRED) BLOWER Hydraulic Roller Swinging Follower Camshafts												
SOHC – Powerful mid-RPM range cam for bolt-on blowers at stock boost levels. Solid power gains above 4400 RPM, requires spring upgrade. Stock gears and converter OK. Requires custom tuning.	Hyd.	Hyd.	850 to 6200	127150	XE253H-15	253	274	214	231	.480	.475	115°
SOHC – Mid to upper range cam for bolt-on blowers with high boost. Noticeable idle, solid power gains above 4900 RPM, requires spring upgrade. Best with 3000+ stall. Requires custom tuning.	Hyd.	Hyd.	950 to 6400	127350	XE261H-16.5	261	282	222	239	.490	.485	116.5°
XFI™ SPR (SPRING & PHASER MODS REQUIRED) Hydraulic Roller Swinging Follower Camshafts												
SOHC – Powerful cam with great idle, excellent upgrade over stock. Good torque down low with powerful mid-range. Solid power gains above 4500 RPM, requires spring and phaser upgrade. Requires custom tuning. Stock gears and converter ok.	Hyd.	Hyd.	900 to 6700	127400*	XE256PH-12	256	267	221	228	.523	.538	112°
SOHC – Powerful cam with very rough idle, biggest cam to use with stock heads. Good midrange torque with incredible top end hp gains. Solid power above 4700 RPM, spring and phaser upgrade required. 3.90+ gears and 3000+ stall. Requires custom tuning.	Hyd.	Hyd.	950 to 6900	127500*	XE264PH-12	264	275	229	236	.535	.550	112°
SOHC – Max effort street/strip cam with very rough idle, needs ported heads. Good midrange with incredible power up to 7000+ RPM. Solid power gains above 4900 RPM, requires spring and phaser upgrade. Custom tuning required. 4.10+ gears and 3200+ stall.	Hyd.	Hyd.	1000 to 7100	127600*	XE272PH-12	272	283	237	244	.547	.560	112°

* Requires cam phaser limiter kit (Part #5449)

FORD 4.6L & 5.4L SOHC MODULAR 3 VALVE 8 CYL. 2004-PRESENT (CONTINUED)

CAMSHAFTS
FORD

K-KIT	SK-KIT	CL-KIT	RP-KIT	LIFTERS	PHASER LIMITER KIT	ROCKER ARMS	PUSHRODS	VALVE SPRINGS	STEEL RETAINERS	TITANIUM RETAINERS	VALVE SEALS	
THUMPR™ NSR (NO SPRINGS REQUIRED) Hydraulic Roller Swinging Follower Camshafts												
N/A	N/A	N/A	N/A	N/A	5449	N/A	N/A	N/A	N/A	N/A	N/A	
N/A	N/A	N/A	N/A	N/A	5449	N/A	N/A	N/A	N/A	N/A	N/A	
N/A	N/A	N/A	N/A	N/A	5449	N/A	N/A	N/A	N/A	N/A	N/A	
XFI™ VSR (VALVE SPRINGS REQUIRED) Hydraulic Roller Swinging Follower Camshafts												
N/A	N/A	N/A	N/A	N/A	5449	N/A	N/A	26113-24 26125-24	700-24	702-24	N/A	
N/A	N/A	N/A	N/A	N/A	5449	N/A	N/A	26113-24 26125-24	700-24	702-24	N/A	
XFI™ VSR (VALVE SPRINGS REQUIRED) BLOWER Hydraulic Roller Swinging Follower Camshafts												
N/A	N/A	N/A	N/A	N/A	5449	N/A	N/A	26113-24 26125-24	700-24	702-24	N/A	
N/A	N/A	N/A	N/A	N/A	5449	N/A	N/A	26113-24 26125-24	700-24	702-24	N/A	
XFI™ SPR (SPRING & PHASER MODS REQUIRED) Hydraulic Roller Swinging Follower Camshafts												
N/A	N/A	N/A	N/A	N/A	5449	N/A	N/A	26113-24 26125-24	700-24	702-24	N/A	
N/A	N/A	N/A	N/A	N/A	5449	N/A	N/A	26113-24 26125-24	700-24	702-24	N/A	
N/A	N/A	N/A	N/A	N/A	5449	N/A	N/A	26125-24	700-24	702-24	N/A	

RED NUMBERS DENOTE PREMIUM OPTION

FORD 4.6L & 5.4L SOHC MODULAR 3 VALVE 8 CYL. 2004-PRESENT (CONTINUED)

APPLICATIONS/CAMSHAFTS	VALVE SETTING		RPM OPERATING RANGE	CAM PART #	CAM GRIND #	DURATION				VALVE LIFT		LOBE SEP. ANGLE
	IN.	EX.				ADVERTISED		@ .050"		W/ 1.825 ROCKER		
						IN.	EX.	IN.	EX.	IN.	EX.	
XFI™ SPR (SPRING & PHASER MODS REQUIRED) BLOWER Hydraulic Roller Swinging Follower Camshafts												
SOHC – Powerful cam with great idle, excellent upgrade over stock. Good torque down low with powerful mid-range. Solid power gains above 4500 RPM, requires spring and phaser upgrade. Requires custom tuning. OK with stock gears.	Hyd.	Hyd.	900 to 6700	127450*	XE264PH-13	264	279	229	240	.535	.555	113°
SOHC – Big power gains in mid to upper RPM range for bolt-on blowers with high boost. Rough idle, solid power gains above 4900 RPM, requires spring and phaser upgrade. Requires custom tuning. Best with 3.90+ gears and 3000+ stall.	Hyd.	Hyd.	950 to 6900	127550*	XE272PH-13	272	287	237	248	.547	.560	113°
SOHC – Max effort blower cam with very rough idle, needs ported heads. Great mid-range power with incredible gains up to 7000+ RPM. Solid power gains above 4900 RPM, requires spring and phaser upgrade. Requires custom tuning. 4.10+ gears and 3200+ stall.	Hyd.	Hyd.	1000 to 7100	127650*	XE280PH-13	280	295	245	256	.559	.560	113°

* Requires cam phaser limiter kit (Part #5449)

FORD 4.6L & 5.4L DOHC MODULAR 4 VALVE 8 CYL. 1993-PRESENT

APPLICATIONS/CAMSHAFTS	VALVE SETTING		RPM OPERATING RANGE	CAM PART #	CAM GRIND #	DURATION				VALVE LIFT		LOBE SEP. ANGLE
	IN.	EX.				ADVERTISED		@ .050"		W/ 1.825 ROCKER		
						IN.	EX.	IN.	EX.	IN.	EX.	
XTREME RPM SERIES Hydraulic Roller Swinging Follower Camshafts												
DOHC – Excellent replacement cam with strong torque. Requires custom tuning.	Hyd.	Hyd.	1000 to 5000	106060*	XE254BH-116	253	253	218	218	.425	.425	116°
DOHC – Great street performance with excellent torque & HP gains with noticeable idle. Requires custom tuning.	Hyd.	Hyd.	1200 to 5400	106100*	XE262AH-114	261	257	226	222	.425	.425	114°
DOHC – Serious street effort with maximum power gains in mid to upper RPM. Requires computer modifications and lower gears. Automatic cars need a 2000+ stall. Requires custom tuning. Mild rough idle.	Hyd.	Hyd.	1500 to 6000	106160*	XE266BH-116	265	265	230	230	.425	.425	116°
DOHC – Street and strip performance. Needs lower gears, exhaust upgrades, larger throttle body and mass air, bigger fuel injectors and a 2200+ stall with automatics. Requires custom tuning. Rough idle.	Hyd.	Hyd.	1800 to 6200	106200*	XE270AH-114	269	265	234	230	.425	.425	114°
XTREME XE-R SERIES Hydraulic Roller Swinging Follower Camshafts												
DOHC – Street performance with excellent torque in normally aspirated engines. Requires custom tuning. Noticeable idle.	Hyd.	Hyd.	1500 to 5800	106300*	XE262AH-114	261	259	226	224	.475	.450	114°
DOHC – Hot performance with serious HP & torque gains. Recommended lower gears, requires custom tuning, larger throttle body, mass air, injectors & exhaust upgrades. Automatics use 2200+ stall. Rough idle.	Hyd.	Hyd.	1800 to 6200	106400*	XE270BH-114	269	267	234	232	.475	.450	114°
DOHC – Race or limited street use. Cams require a larger throttle body, mass air, injectors, exhaust upgrades and requires custom tuning. Automatics need a 3000+ stall. Very rough idle.	Hyd.	Hyd.	2200 to 6500	106500*	XE278AH-114	277	275	242	240	.475	.450	114°

* Requires aftermarket valve springs/retainers.

FORD 4.6L & 5.4L SOHC MODULAR 3 VALVE 8 CYL. 2004-PRESENT (CONTINUED)

K-KIT	SK-KIT	CL-KIT	RP-KIT	LIFTERS	PHASER LIMITER KIT	ROCKER ARMS	PUSHRODS	VALVE SPRINGS	RETAINERS	VALVE LOCKS	VALVE SEALS	
XFI™ SPR (SPRING & PHASER MODS REQUIRED) BLOWER Hydraulic Roller Swinging Follower Camshafts												
N/A	N/A	N/A	N/A	N/A	5449	N/A	N/A	26125-24	700-24	702-24	N/A	
N/A	N/A	N/A	N/A	N/A	5449	N/A	N/A	26125-24	700-24	702-24	N/A	
N/A	N/A	N/A	N/A	N/A	5449	N/A	N/A	26125-24	700-24	702-24	N/A	

FORD 4.6L & 5.4L DOHC MODULAR 4 VALVE 8 CYL. 1993-PRESENT

K-KIT	SK-KIT	CL-KIT	RP-KIT	LIFTERS	CAM GEAR SET	ROCKER ARMS	PUSHRODS	VALVE SPRINGS	RETAINERS	VALVE LOCKS	VALVE SEALS	
XTREME RPM SERIES Hydraulic Roller Swinging Follower Camshafts												
N/A	N/A	N/A	N/A	N/A	10254	N/A	N/A	26123-32	799-32 798-32	N/A	N/A	
N/A	N/A	N/A	N/A	N/A	10254	N/A	N/A	26123-32	799-32 798-32	N/A	N/A	
N/A	N/A	N/A	N/A	N/A	10254	N/A	N/A	26123-32	799-32 798-32	N/A	N/A	
N/A	N/A	N/A	N/A	N/A	10254	N/A	N/A	26123-32	799-32 798-32	N/A	N/A	
XTREME XE-R SERIES Hydraulic Roller Swinging Follower Camshafts												
N/A	N/A	N/A	N/A	N/A	10254	N/A	N/A	26123-32	799-32 798-32	N/A	N/A	
N/A	N/A	N/A	N/A	N/A	10254	N/A	N/A	26123-32	799-32 798-32	N/A	N/A	
N/A	N/A	N/A	N/A	N/A	10254	N/A	N/A	26123-32	799-32 798-32	N/A	N/A	

Note: For 5.4L GT500 applications, you MUST use these REQUIRED parts: 26125-16 valve springs & either 792-16 steel or 791-16 titanium retainers for the intake AND 26123-16 valve springs & either 799-16 steel or 798-16 titanium retainers for the exhaust. These are available in kit form that includes springs and retainers: Part #GT500ST-KIT (steel retainers) and #GT500TI-KIT (titanium retainers).

RED NUMBERS DENOTE PREMIUM OPTION



FORD 4.6L & 5.4L DOHC MODULAR 4 VALVE 8 CYL. 1993-PRESENT (CONTINUED)

APPLICATIONS/CAMSHAFTS	VALVE SETTING		RPM OPERATING RANGE	CAM PART #	CAM GRIND #	DURATION				VALVE LIFT		LOBE SEP. ANGLE
	IN.	EX.				ADVERTISED IN.	EX.	@ .050" IN.	EX.	W/ 1.825 ROCKER IN.	EX.	
XE-R SUPERCHARGED & NITROUS SERIES Hydraulic Roller Swinging Follower Camshafts												
DOHC – Street performance w/ excellent torque. Works well in supercharged or nitrous engines. Requires custom tuning.	Hyd.	Hyd.	1200 to 5800	106260*	XE258BH-116	257	259	222	224	.475	.450	116°
DOHC – Serious street effort for supercharged or nitrous applications. Requires custom tuning & lower gears. Automatics require 2000+ stall. Mild rough idle.	Hyd.	Hyd.	1500 to 6000	106360*	XE266BH-116	265	267	230	232	.475	.450	116°
DOHC – Max strip/street cams for centrifugal supercharged or nitrous engines. Large gains in power with larger throttle body, mass air, injectors and exhaust upgrades. Requires lower gears and custom tuning. Automatics use a 2500+ stall. Features a rough idle.	Hyd.	Hyd.	2000 to 6400	106460*	XE274BH-116	273	275	238	240	.475	.450	116°

* Requires cam gear set (#10254), and aftermarket valve springs/retainers.

FORD COYOTE 5.0L DOHC MODULAR 4 VALVE 8 CYL. 2011-PRESENT

APPLICATIONS/CAMSHAFTS	VALVE SETTING		RPM OPERATING RANGE	CAM PART #	CAM GRIND #	DURATION				VALVE LIFT		LOBE SEP. ANGLE**
	IN.	EX.				ADVERTISED IN.	EX.	@ .050" IN.	EX.	W/ 1.825 ROCKER IN.	EX.	
XFI™ NSR (NO SPRINGS REQUIRED) Hydraulic Roller Swinging/Finger Follower Camshafts												
DOHC – Great upgrade over stock. Good power gains above 4500 RPM. Requires custom ECU programming.	Hyd.	Hyd.	1500-6800	191060*	F5.0D NSR-NA1H-126	260	267	220	223	.492	.453	126°
DOHC – Big power gains in mid to upper RPM range, especially above 4900 RPM. Requires custom ECU programming.	Hyd.	Hyd.	1700-7000	191100*	F5.0D NSR-NA2H-126	268	275	228	231	.492	.453	126°
DOHC – Max effort street/strip cam set. Strong power gains above 5500-7200+. Full length headers and 3.73+ gear. Requires custom ECU programming.	Hyd.	Hyd.	1900-7200	191160*	F5.0D NSR-NA3H-126	276	283	236	239	.492	.453	126°
XFI™ NSR (NO SPRINGS REQUIRED) BLOWER Hydraulic Roller Swinging/Finger Follower Camshafts												
DOHC – Great upgrade over stock cams with bolt-on blowers and standard boost levels. Requires custom ECU programming.	Hyd.	Hyd.	1500-6900	191260*	F5.0D NSR-BL1H-128	260	271	220	227	.492	.453	128°
DOHC – Big power gains in mid to upper RPM range for blower kits with higher boost. Requires custom ECU programming.	Hyd.	Hyd.	1700-7100	191360*	F5.0D NSR-BL2H-128	268	279	228	235	.492	.453	128°
DOHC – Max effort street/strip cam set. Best choice when running higher boost levels and high RPM in modified engines. Requires ECU programming.	Hyd.	Hyd.	2000-7300	191460*	F5.0D NSR-BL3H-128	276	287	236	243	.492	.453	128°

* Requires cam phaser limiter kit (Part #5493) or optional cam phaser lock kit (#5492) for race applications.

** This is the effective Lobe Separation Angle (LSA) with intake and exhaust cams in their resting or “parked” positions. When using these cams with the required COMP Cams® Phaser Limiter Kit, this is the MAXIMUM effective LSA but when running they can be tuned TIGHTER by as much as 40°.

FORD 4.6L & 5.4L DOHC MODULAR 4 VALVE 8 CYL. 1993-PRESENT (CONTINUED)

K-KIT	SK-KIT	CL-KIT	RP-KIT	LIFTERS	CAM GEAR SET	ROCKER ARMS	PUSHRODS	VALVE SPRINGS	RETAINERS	VALVE LOCKS	VALVE SEALS	
XE-R SUPERCHARGED & NITROUS SERIES Hydraulic Roller Swinging Follower Camshafts												
N/A	N/A	N/A	N/A	N/A	10254	N/A	N/A	26123-32	799-32 798-32	N/A	N/A	
N/A	N/A	N/A	N/A	N/A	10254	N/A	N/A	26123-32	799-32 798-32	N/A	N/A	
N/A	N/A	N/A	N/A	N/A	10254	N/A	N/A	26123-32	799-32 798-32	N/A	N/A	

Note: For 5.4L GT500 applications, you MUST use these REQUIRED parts: 26125-16 valve springs & either 792-16 steel or 791-16 titanium retainers for the intake AND 26123-16 valve springs & either 799-16 steel or 798-16 titanium retainers for the exhaust. These are available in kit form that includes springs and retainers: Part #GT500ST-KIT (steel retainers) and #GT500TI-KIT (titanium retainers).

FORD COYOTE 5.0L DOHC MODULAR 4 VALVE 8 CYL. 2011-PRESENT

K-KIT	SK-KIT	CL-KIT	RP-KIT	LIFTERS	CAM PHASER LIMITER KIT	CAM PHASER LOCK KIT	PUSHRODS	VALVE SPRINGS	RETAINERS	VALVE LOCKS	VALVE SEALS	
XFI™ NSR (NO SPRINGS REQUIRED) Hydraulic Roller Swinging/Finger Follower Camshafts												
N/A	N/A	N/A	N/A	N/A	5493	5492	N/A	N/A	N/A	N/A	N/A	
N/A	N/A	N/A	N/A	N/A	5493	5492	N/A	N/A	N/A	N/A	N/A	
N/A	N/A	N/A	N/A	N/A	5493	5492	N/A	N/A	N/A	N/A	N/A	
XFI™ NSR (NO SPRINGS REQUIRED) BLOWER Hydraulic Roller Swinging/Finger Follower Camshafts												
N/A	N/A	N/A	N/A	N/A	5493	5492	N/A	N/A	N/A	N/A	N/A	
N/A	N/A	N/A	N/A	N/A	5493	5492	N/A	N/A	N/A	N/A	N/A	
N/A	N/A	N/A	N/A	N/A	5493	5492	N/A	N/A	N/A	N/A	N/A	

FORD 221-302 C.I. 8 CYL. 1963-1995 (INCLUDES 221, 260, 289 & 302)

APPLICATIONS/CAMSHAFTS	VALVE SETTING		RPM OPERATING RANGE	CAM PART #	CAM GRIND #	DURATION				VALVE LIFT		LOBE SEP. ANGLE
	IN.	EX.				ADVERTISED IN.	EX.	@ .050" IN.	EX.	W/ 1.6 ROCKER IN.	EX.	
HIGH ENERGY™ Hydraulic Flat Tappet Camshafts												
HYDRAULIC – 289c.i. with automatic, stock gears. Good torque and economy, very smooth idle.	Hyd.	Hyd.	800 to 4500	31-115-4	240H	240	248	192	200	.416	.416	108°
HYDRAULIC – Good for low RPM torque in 289-302. Good towing in 302 automatic. Smooth idle.	Hyd.	Hyd.	800 to 4800	31-215-2	252H	252	252	206	206	.433	.433	110°
HYDRAULIC – Excellent combo of torque and power. Best for towing in 302 stick with low gears.	Hyd.	Hyd.	1200 to 5200	31-216-2	260H	260	260	212	212	.447	.447	110°
HYDRAULIC – Good for daily driven performance vehicles. Mid-range power. Slightly lower gears. Mild rough idle.	Hyd.	Hyd.	1500 to 5500	31-218-2	268H	268	268	218	218	.456	.456	110°
MAGNUM Hydraulic Flat Tappet Camshafts												
HYDRAULIC – Performance use. Best w/ mild converter, headers, 9:1 compression & lower gears. Rough idle.	Hyd.	Hyd.	1800 to 5800	31-414-3	270H	270	270	224	224	.500	.500	110°
HYDRAULIC – Broad power. 2500+ stall, low gears, 9.5:1 compression and headers. Rough idle.	Hyd.	Hyd.	2000 to 6000	31-226-3	280H	280	280	230	230	.512	.512	110°
HYDRAULIC – Street/strip use. 3500+ stall or 4 speed, 4.10 gear and 10.5:1 compression. Very rough idle.	Hyd.	Hyd.	2500 to 6500	31-330-3	292H	292	292	244	244	.534	.534	110°
HYDRAULIC – Limited street use or bracket race. 11:1 compression, intake and exhaust. Radical idle.	Hyd.	Hyd.	3000 to 7000	31-331-4	305H	305	305	253	253	.540	.540	110°
XTREME ENERGY™ Hydraulic Flat Tappet Camshafts												
HYDRAULIC – Very strong torque, excellent mileage, smooth idle.	Hyd.	Hyd.	600 to 4800	31-230-3	XE250H	250	260	206	212	.460	.474	110°
HYDRAULIC – Strong torque thru low end and mid-range, good idle.	Hyd.	Hyd.	1000 to 5200	31-234-3	XE256H	256	268	212	218	.477	.484	110°
HYDRAULIC – Excellent response, good mid-range, stock converter, 3.23-4.10 gear.	Hyd.	Hyd.	1300 to 5600	31-238-3	XE262H	262	270	218	224	.493	.500	110°
HYDRAULIC – Great for street machine, 2200+ stall.	Hyd.	Hyd.	1600 to 5800	31-242-3	XE268H	268	280	224	230	.509	.512	110°
HYDRAULIC – Very strong torque and throttle response, 2500+ stall.	Hyd.	Hyd.	1800 to 6000	31-246-3	XE274H	274	286	230	236	.520	.523	110°
HYDRAULIC – Street/strip, 2800+ stall, headers, gears, rough idle.	Hyd.	Hyd.	2300 to 6500	31-250-4	XE284H	284	296	240	246	.541	.544	110°
HYDRAULIC – Pro Street/bracket, good intake, headers, gear, 3300+ stall.	Hyd.	Hyd.	2800 to 7000	31-254-4	XE294H	294	306	250	256	.554	.558	110°
THUMPR™ Hydraulic Flat Tappet Camshafts												
HYDRAULIC – Thumpr™ – High performance street, stock converter ok, best with 2000+ converter and gears. Choppy/thumping idle.	Hyd.	Hyd.	2000 to 5800	31-601-5	279TH7	279	296	227	241	.491	.476	107°
HYDRAULIC – Mutha' Thumpr™ – High performance street/strip, needs 9:1 compression, 2500+ stall, intake, gears and headers, rough idle.	Hyd.	Hyd.	2200 to 6100	31-602-5	287TH7	287	304	235	249	.500	.486	107°
HYDRAULIC – Big Mutha' Thumpr™ – Street/strip, needs 9.5:1 compression, 2800+ stall, intake, gears and headers, very rough idle.	Hyd.	Hyd.	2500 to 6400	31-603-5	295TH7	295	312	243	257	.512	.497	107°

¹ Requires screw-in studs & guide plates
² Requires machining on cylinder heads

³³ Pre-1972 engines use Part #3220
³⁵ Part #4504 studs required for 1978-present

³⁶ 1962-69 use Part #7632-16
³⁷ Adjustable valve train required

FORD 221-302 C.I. 8 CYL. 1963-1995 (INCLUDES 221, 260, 289 & 302)

CAMSHAFTS FORD

K-KIT	CL-KIT	RP-KIT	LIFTERS	DIST. GEAR	TIMING SET	ROCKER ARMS	PUSHRODS	VALVE SPRINGS	RETAINERS	VALVE LOCKS	VALVE SEALS
HIGH ENERGY™ Hydraulic Flat Tappet Camshafts											
K31-115-4	CL31-115-4	RP1431-16 ^{36,38}	832-16	35200 35100	3230 ³³ 2120 ³³	1431-16 ^{35,56} 1631-16 ¹	7831-16 ³⁶ 7631-16 ³⁶	942-16 972-16	768-16 743-16	601-16	502-16
K31-215-2	CL31-215-2	RP1431-16 ^{36,38}	832-16	35200 35100	3230 ³³ 2120 ³³	1431-16 ^{35,56} 1631-16 ¹	7831-16 ³⁶ 7631-16 ³⁶	942-16 972-16	768-16 743-16	601-16	502-16
K31-216-2	CL31-216-2	RP1431-16 ^{36,38}	832-16	35200 35100	3230 ³³ 2120 ³³	1431-16 ^{35,56} 1631-16 ¹	7831-16 ³⁶ 7631-16 ³⁶	942-16 972-16	768-16 743-16	601-16	502-16
K31-218-2	CL31-218-2	RP1431-16 ^{36,38}	832-16	35200 35100	3230 ³³ 2120 ³³	1431-16 ^{35,56} 1631-16 ¹	7831-16 ³⁶ 7631-16 ³⁶	942-16 972-16	768-16 743-16	601-16	502-16
MAGNUM Hydraulic Flat Tappet Camshafts											
K31-414-3	CL31-414-3	RPM1431-16 ^{35,39}	832-16	35200 35100	2120 ³³ 3120 ³³	1431-16 ^{35,56} 1631-16 ¹	7631-16 ³⁶ 7933-16 ³⁶	942-16 972-16	747-16 740-16	611-16	502-16
K31-226-3	CL31-226-3	RPM1431-16 ^{35,39}	832-16	35200 35100	2120 ³³ 3120 ³³	1431-16 ^{35,56} 1631-16 ¹	7631-16 ³⁶ 7933-16 ³⁶	942-16 972-16	747-16 740-16	611-16	502-16
K31-330-3	CL31-330-3	RPM1431-16 ^{35,39}	832-16	35200 35100	2120 ³³ 3120 ³³	1431-16 ^{35,56} 1631-16 ¹	7631-16 ³⁶ 7933-16 ³⁶	986-16 ² 26986-16 ²	740-16 795-16	611-16 614-16	503-16 ²
K31-331-4	CL31-331-4	RPM1431-16 ^{35,39}	832-16	35200 35100	2120 ³³ 3120 ³³	1431-16 ^{35,56} 1631-16 ¹	7631-16 ³⁶ 7933-16 ³⁶	986-16 ² 26986-16 ²	740-16 795-16	611-16 614-16	503-16 ²
XTREME ENERGY™ Hydraulic Flat Tappet Camshafts											
K31-230-3	CL31-230-3	RP1431-16 ^{36,38}	832-16 862-16 ³⁷	35200 35100	3230 ³³ 2120 ³³	1431-16 ^{35,56} 1631-16 ¹	7831-16 ³⁶ 7631-16 ³⁶	942-16 972-16	768-16 743-16	601-16	502-16
K31-234-3	CL31-234-3	RP1431-16 ^{36,38}	832-16 862-16 ³⁷	35200 35100	3230 ³³ 2120 ³³	1431-16 ^{35,56} 1631-16 ¹	7831-16 ³⁶ 7631-16 ³⁶	942-16 972-16	768-16 743-16	601-16	502-16
K31-238-3	CL31-238-3	RP1431-16 ^{36,38}	832-16 862-16 ³⁷	35200 35100	3230 ³³ 2120 ³³	1431-16 ^{35,56} 1631-16 ¹	7831-16 ³⁶ 7631-16 ³⁶	942-16 972-16	768-16 743-16	601-16	502-16
K31-242-3	CL31-242-3	RP1431-16 ^{36,38}	832-16 862-16 ³⁷	35200 35100	3230 ³³ 2120 ³³	1431-16 ^{35,56} 1631-16 ¹	7831-16 ³⁶ 7631-16 ³⁶	942-16 972-16	768-16 743-16	601-16	502-16
K31-246-3	CL31-246-3	RPM1431-16 ^{35,39}	832-16 862-16 ³⁷	35200 35100	2120 ³³ 3120 ³³	1431-16 ^{35,56} 1631-16 ¹	7631-16 ³⁶ 7933-16 ³⁶	986-16 ² 26986-16 ²	740-16 795-16	611-16 614-16	503-16 ²
K31-250-4	CL31-250-4	RPM1431-16 ^{35,39}	832-16 862-16 ³⁷	35200 35100	2120 ³³ 3120 ³³	1431-16 ^{35,56} 1631-16 ¹	7631-16 ³⁶ 7933-16 ³⁶	986-16 ² 26986-16 ²	740-16 795-16	611-16 614-16	503-16 ²
K31-254-4	CL31-254-4	RPM1431-16 ^{35,39}	832-16 862-16 ³⁷	35200 35100	2120 ³³ 3120 ³³	1431-16 ^{35,56} 1631-16 ¹	7631-16 ³⁶ 7933-16 ³⁶	986-16 ² 26986-16 ²	740-16 795-16	611-16 614-16	503-16 ²
THUMPR™ Hydraulic Flat Tappet Camshafts											
K31-601-5	CL31-601-5	RP1431-16 ^{36,38}	832-16 862-16 ³⁷	35200 35100	3230 ³³ 2120 ³³	1431-16 ^{35,56} 1631-16 ¹	7831-16 ³⁶ 7631-16 ³⁶	942-16 972-16	768-16 743-16	601-16	502-16
K31-602-5	CL31-602-5	RP1431-16 ^{36,38}	832-16 862-16 ³⁷	35200 35100	3230 ³³ 2120 ³³	1431-16 ^{35,56} 1631-16 ¹	7831-16 ³⁶ 7631-16 ³⁶	942-16 972-16	768-16 743-16	601-16	502-16
K31-603-5	CL31-603-5	RP1431-16 ^{36,38}	832-16 862-16 ³⁷	35200 35100	3230 ³³ 2120 ³³	1431-16 ^{35,56} 1631-16 ¹	7831-16 ³⁶ 7631-16 ³⁶	986-16 ² 26986-16 ²	740-16 795-16	611-16 614-16	503-16 ²

³⁸ For 1.7:1 ratio use Part #RP1453-16
³⁹ For 1.7:1 ratio use Part #RPM1453-16

⁵⁶ If equipped w/ studs & guide plates, use Part #1442-16

RED NUMBERS DENOTE PREMIUM OPTION



FORD 221-302 C.I. 8 CYL. 1963-1995 (INCLUDES 221, 260, 289 & 302) (CONTINUED)

APPLICATIONS/CAMSHAFTS	VALVE SETTING		RPM OPERATING RANGE	CAM PART #	CAM GRIND #	DURATION				VALVE LIFT		LOBE SEP. ANGLE
	IN.	EX.				ADVERTISED IN.	EX.	@ .050" IN.	EX.	W/ 1.6 ROCKER IN.	EX.	
MARINE Hydraulic Flat Tappet Camshafts												
HYDRAULIC – Good vacuum. Better torque & power.	Hyd.	Hyd.	800 to 4800	31-213-4	252BH	252	252	201	206	.432	.432	112°
HYDRAULIC – Excellent economy, pleasure and skiing use, fairly smooth idle.	Hyd.	Hyd.	1200 to 5200	31-216-2	260H	260	260	212	212	.447	.447	110°
HYDRAULIC – Single or dual engines. Best for inboard/outboard. Noticeable idle.	Hyd.	Hyd.	1500 to 5500	31-218-2	268H	268	268	218	218	.456	.456	110°
HYDRAULIC – Off shore type boat. Strong performance, rough idle.	Hyd.	Hyd.	2000 to 6000	31-226-3	280H	280	280	230	230	.512	.512	110°

APPLICATIONS/CAMSHAFTS	VALVE SETTING		RPM OPERATING RANGE	CAM PART #	CAM GRIND #	DURATION				VALVE LIFT		LOBE SEP. ANGLE
	IN.	EX.				ADVERTISED IN.	EX.	@ .050" IN.	EX.	W/ 1.6 ROCKER IN.	EX.	
DUAL ENERGY™ Hydraulic Flat Tappet Camshafts												
HYDRAULIC – Good torque, good mileage. Excellent low end torque. Smooth idle.	Hyd.	Hyd.	1000 to 5500	31-416-3	255DEH	255	263	203	216	.434	.467	110°
HYDRAULIC – Very strong mid-range. Every day performance for stock exhaust.	Hyd.	Hyd.	1600 to 5750	31-409-3	265DEH	265	273	211	223	.472	.486	110°
HYDRAULIC – High performance. High end power. 2000+ RPM stall recommended. Choppy idle.	Hyd.	Hyd.	2000 to 6000	31-418-3	275DEH	275	283	219	233	.477	.510	110°

NOSTALGIA PLUS™ Hydraulic Flat Tappet Camshaft												
HYDRAULIC – Sound of Ford 271 HP 289 cam with hydraulic lifters and increased performance.	Hyd.	Hyd.	2200 to 6400	31-670-4	N+271H	266	273	219	226	.480	.475	112°

APPLICATIONS/CAMSHAFTS	VALVE SETTING		RPM OPERATING RANGE	CAM PART #	CAM GRIND #	DURATION				VALVE LIFT		LOBE SEP. ANGLE
	IN.	EX.				ADVERTISED IN.	EX.	@ .050" IN.	EX.	W/ 1.6 ROCKER IN.	EX.	
XTREME ENERGY™ Computer Controlled Hydraulic Flat Tappet Camshaft (FOR EFI)												
HYDRAULIC – EFI speed density, works w/ stock computer. Very strong torque, great mileage, good idle quality.	Hyd.	Hyd.	1000 to 5200	31-255-5	XE250H-14	250	260	206	212	.462	.474	114°

DRAG RACE Hydraulic Flat Tappet Camshaft												
HYDRAULIC – Good for 4 speed or 3500+ stall, 10.5:1+ compression.	Hyd.	Hyd.	3800 to 6800	31-331-4	305AH-10	305	305	253	253	.540	.540	110°

APPLICATIONS/CAMSHAFTS	VALVE SETTING		RPM OPERATING RANGE	CAM PART #	CAM GRIND #	DURATION				VALVE LIFT		LOBE SEP. ANGLE
	IN.	EX.				ADVERTISED IN.	EX.	@ .050" IN.	EX.	W/ 1.6 ROCKER IN.	EX.	
MAGNUM Retro-Fit Hydraulic Roller Camshafts (NOT FOR EFI)												

For Engines That DID NOT Come From The Factory With Hydraulic Roller Cams

HYDRAULIC ROLLER – Best with stock engine or slightly modified engine for economy or towing. Stock converter. Smooth idle.	Hyd.	Hyd.	1200 to 4500	31-412-8³¹	260HR	260	260	206	206	.480	.480	110°
HYDRAULIC ROLLER – Good performance increase for highway cruiser. Slightly noticeable idle.	Hyd.	Hyd.	1800 to 5000	31-422-8³¹	270HR	270	270	215	215	.533	.533	110°
HYDRAULIC ROLLER – Great for street machines. Best power increase above 3500 RPM, good torque, mild idle.	Hyd.	Hyd.	2000 to 5500	31-432-8³¹	281HR	281	281	220	220	.512	.512	110°
HYDRAULIC ROLLER – Street machine and limited high performance street use. 3.40-4.10 gears. Aftermarket intake and headers. Mild/rough idle.	Hyd.	Hyd.	2500 to 6000	31-442-8³¹	284HR	284	284	224	224	.533	.533	110°
HYDRAULIC ROLLER – Street/strip only, 4 speed and 4.10 or lower gear. 9:1 compression, aftermarket intake, headers and 2500+ converter.	Hyd.	Hyd.	3000 to 6500	31-452-8³¹	290HR	290	290	230	230	.544	.544	110°

¹ Requires screw-in studs & guide plates
² Requires machining on cylinder heads

⁷ Stock springs cannot be used

³¹ These cams can only be used in 289-302 engines. NOT 302 H.O. blocks due to base circle size.

FORD 221-302 C.I. 8 CYL. 1963-1995 (INCLUDES 221, 260, 289 & 302) (CONTINUED)

LIFTERS	TIMING SET	ROCKER ARMS	PUSHRODS	VALVE SPRINGS	RETAINERS	VALVE LOCKS	VALVE SEALS	LASH CAPS	REV KIT	DIST. GEAR	STUD GIRDLES
MARINE Hydraulic Flat Tappet Camshafts											
832-16	3120	1431-16 ^{35,56}	7631-16 ³⁶	942-16	768-16	601-16	502-16	621-16	N/A	35200	4013 ¹
832-16	3120	1431-16 ^{35,56}	7631-16 ³⁶	942-16	768-16	601-16	502-16	621-16	N/A	35200	4013 ¹
832-16	3120	1431-16 ^{35,56}	7631-16 ³⁶	942-16	768-16	601-16	502-16	621-16	N/A	35200	4013 ¹
832-16	3120	1431-16 ^{35,56}	7631-16 ³⁶ 7933-16 ³⁶	972-16	747-16 730-16	611-16	502-16	621-16	N/A	35200 35100	4013 ¹

K-KIT	CL-KIT	RP-KIT	LIFTERS	DIST. GEAR	TIMING SET	ROCKER ARMS	PUSHRODS	VALVE SPRINGS	RETAINERS	VALVE LOCKS	VALVE SEALS
DUAL ENERGY™ Hydraulic Flat Tappet Camshafts											
K31-416-3	CL31-416-3 ⁷	RP1431-16 ^{35,38}	832-16 862-16 ³⁷	35200 35100	3230 ³³ 2120	1431-16 ^{35,56} 1631-16 ¹	7831-16 ³⁶ 7631-16 ³⁶	942-16 972-16	768-16 747-16	601-16 611-16	502-16
K31-409-3	CL31-409-3 ⁷	RP1431-16 ^{35,38}	832-16 862-16 ³⁷	35200 35100	3230 ³³ 2120	1431-16 ^{35,56} 1631-16 ¹	7831-16 ³⁶ 7631-16 ³⁶	942-16 972-16	768-16 747-16	601-16 611-16	502-16
K31-418-3	CL31-418-3 ⁷	RP1431-16 ^{35,38}	832-16 862-16 ³⁷	35200 35100	3230 ³³ 2120	1431-16 ^{35,56} 1631-16 ¹	7831-16 ³⁶ 7631-16 ³⁶	942-16 972-16	768-16 747-16	601-16 611-16	502-16
NOSTALGIA PLUS™ Hydraulic Flat Tappet Camshaft											
K31-670-4	CL31-670-4 ⁷	RP1431-16 ^{35,38}	832-16 862-16 ³⁷	35200 35100	2120 3120	1431-16 ^{35,56} 1631-16 ¹	7831-16 ³⁶ 7631-16 ³⁶	942-16 972-16	768-16 747-16	601-16 611-16	502-16

LIFTERS	TIMING SET	ROCKER ARMS	PUSHRODS	VALVE SPRINGS	RETAINERS	VALVE LOCKS	VALVE SEALS	LASH CAPS	REV KIT	DIST. GEAR	STUD GIRDLES
XTREME ENERGY™ Computer Controlled Hydraulic Flat Tappet Camshaft (FOR EFI)											
832-16 862-16 ³⁷	3120	1431-16 ^{35,56}	7631-16 ³⁶	942-16 972-16	768-16 747-16	601-16 611-16	502-16	621-16	N/A	35200 35100	4013 ¹
DRAG RACE Hydraulic Flat Tappet Camshaft											
862-16 ³⁷	3120	1631-16 ¹ 1831-16 ¹	7933-16	987-16 ² 950-16 ²	740-16 730-16	611-16	503-16 ²	621-16	N/A	35200 35100	4013 ¹

K-KIT	CL-KIT	RP-KIT	LIFTERS	DIST. GEAR	TIMING SET	ROCKER ARMS	PUSHRODS	VALVE SPRINGS	RETAINERS	VALVE LOCKS	VALVE SEALS
MAGNUM Retro-Fit Hydraulic Roller Camshafts (NOT FOR EFI)											
K31-412-8	CL31-412-8 ⁷	RPR1428-16 ³⁵	851-16 8931-16	431M	2120 ³³ 3120	1431-16 ^{35,56} 1631-16 ¹	7819-16 7754-16	986-16 ² 26986-16	740-16 795-16	611-16 614-16	503-16 ²
K31-422-8	CL31-422-8 ⁷	RPR1428-16 ³⁵	851-16 8931-16	431M	2120 ³³ 3120	1431-16 ^{35,56} 1631-16 ¹	7819-16 7754-16	986-16 ² 26986-16	740-16 795-16	611-16 614-16	503-16 ²
K31-432-8	CL31-432-8 ⁷	RPR1428-16 ³⁵	851-16 8931-16	431M	2120 ³³ 3120	1431-16 ^{35,56} 1631-16 ¹	7819-16 7754-16	986-16 ² 26986-16	740-16 795-16	611-16 614-16	503-16 ²
K31-442-8	CL31-442-8 ⁷	RPR1428-16 ³⁵	851-16 8931-16	431M	2120 ³³ 3120	1431-16 ^{35,56} 1631-16 ¹	7819-16 7754-16	986-16 ² 26986-16	740-16 795-16	611-16 614-16	503-16 ²
K31-452-8	CL31-452-8 ⁷	RPR1428-16 ³⁵	851-16 8931-16	431M	2120 ³³ 3120	1431-16 ^{35,56} 1631-16 ¹	7819-16 7754-16	986-16 ² 26986-16	740-16 795-16	611-16 614-16	503-16 ²

³³ Pre-1972 engines use Part #3220

³⁵ Part #4504 studs required for 1978-present

³⁶ 1962-69 use Part #7632-16

³⁷ Adjustable valve train required

³⁸ For 1.7:1 ratio use Part #RP1453-16

⁵⁶ If equipped w/ studs & guide plates, use Part #1442-16

FORD 221-302 C.I. 8 CYL. 1963-1995 (INCLUDES 221, 260, 289 & 302) (CONTINUED)

APPLICATIONS/CAMSHAFTS	VALVE SETTING		RPM OPERATING RANGE	CAM PART #	CAM GRIND #	DURATION				VALVE LIFT		LOBE SEP. ANGLE
	IN.	EX.				ADVERTISED IN.	EX.	@ .050" IN.	EX.	W/ 1.6 ROCKER IN.	EX.	
THUMPR™ Retro-Fit Hydraulic Roller Camshafts												
HYDRAULIC ROLLER – Thumpr™ High performance street, stock converter ok, best with 2000+ converter and gears, choppy/thumping idle.	Hyd.	Hyd.	1900 to 5600	31-600-8³¹	283THR7	283	303	227	241	.531	.515	107°
HYDRAULIC ROLLER – Mutha' Thumpr™ High performance street/strip, needs 9:1 compression, 2500+ stall, intake, gears and headers, rough idle.	Hyd.	Hyd.	2200 to 5900	31-601-8³¹	291THR7	291	311	235	249	.540	.526	107°
HYDRAULIC ROLLER – Big Mutha' Thumpr™ Street/strip, needs 9.5:1 compression, 2800+ stall, intake, gears and headers, very rough idle.	Hyd.	Hyd.	2500 to 6200	31-602-8³¹	299THR7	299	319	243	257	.552	.537	107°
MAGNUM Mechanical Flat Tappet Camshafts												
SOLID – Daily usage in performance vehicles. Broad power, good driveability, stock gear and compression. Mild rough idle. 2000 converter recommended.	.022	.022	1800 to 5800	31-333-4	270S	270	270	224	224	.499	.499	110°
SOLID – Performance cam for street machines. Lower axle ratio and 2500+ stall with headers. Rough idle.	.022	.022	2000 to 6000	31-334-4	282S	282	282	236	236	.528	.528	110°
SOLID – Great for street/strip. 4 speed or automatic with 3500+ stall. Intake, headers, low gears, very rough idle, 10:1 compression.	.022	.022	2500 to 6500	31-335-4	294S	294	294	248	248	.560	.560	110°
SOLID – Limited street use, with 4000+ stall or 4 speed, with 4.10 or lower gear.	.022	.022	3000 to 7000	31-336-4	306S	306	306	260	260	.592	.592	110°
NOSTALGIA PLUS™ Mechanical Flat Tappet Camshaft												
SOLID – Outstanding power and modern tight lash with Ford 271 HP 289 cam sound.	.012	.012	2200 to 6800	31-671-4	N+271S	262	269	225	232	.495	.495	112°
FACTORY MUSCLE™ Mechanical Flat Tappet Camshaft (Today's Version Of Yesterday's Muscle Car Cams)												
SOLID – Factory I.D. #C30Z-6250-C for 289c.i. 1965-68, factory 271 HP.	.022	.022	2200 to 6200	31-110-5	C30ZS	263	261	228	227	.478	.475	114°
MAGNUM MUSCLE Mechanical Flat Tappet Camshaft (Today's Version Of Yesterday's Muscle Car Cams)												
SOLID – Magnum Muscle Camshaft for 289c.i. 1965-68, factory 271 HP.	.022	.022	2500 to 6500	31-334-4	282S	270	270	236	236	.528	.528	110°
DRAG RACE Mechanical Flat Tappet Camshaft												
SOLID – Good torque for small engines, 3500+ stall, 10:1 compression.	.022	.022	3000 to 7000	31-639-5	280B-6	280	284	242	246	.541	.522	106°
SOLID – Best baseline race cam, 10.5:1 compression, 3500+ stall, good power.	.022	.022	3000 to 7000	31-609-5	285B-6	285	295	250	260	.568	.592	106°
SOLID – Good for 4000+ stall in medium to heavy cars, 10.5:1 compression.	.022	.022	3000 to 7000	31-640-5	290B-6	290	304	255	266	.576	.570	106°
SOLID – Light car with 4 speed or 4500+ stall, 11:1 compression.	.022	.022	3000 to 7000	31-641-5	300B-6	300	314	265	276	.600	.593	106°

¹ Requires screw-in studs & guide plates
² Requires machining on cylinder heads
⁷ Stock springs cannot be used

³¹ These cams can only be used in 289-302 engines. NOT 302 H.O. blocks due to base circle size.
³³ Pre-1972 engines use Part #3220

³⁵ Part #4504 studs required for 1978-present
³⁶ 1962-69 use Part #7632-16

FORD 221-302 C.I. 8 CYL. 1963-1995 (INCLUDES 221, 260, 289 & 302) (CONTINUED)

CAMSHAFTS FORD

K-KIT	CL-KIT	RP-KIT	LIFTERS	DIST. GEAR	TIMING SET	ROCKER ARMS	PUSHRODS	VALVE SPRINGS	RETAINERS	VALVE LOCKS	VALVE SEALS	
THUMPR™ Retro-Fit Hydraulic Roller Camshafts												
K31-600-8	CL31-600-8 ⁷	RPR1428-16 ³⁵	851-16 8931-16	431M	2120 ³³ 3120	1431-16 ^{35,56} 1631-16 ¹	7819-16 7754-16	986-16 ² 26986-16 ²	740-16 795-16	611-16 614-16	503-16 ²	
K31-601-8	CL31-601-8 ⁷	RPR1428-16 ³⁵	851-16 8931-16	431M	2120 ³³ 3120	1431-16 ^{35,56} 1631-16 ¹	7819-16 7754-16	986-16 ² 26986-16 ²	740-16 795-16	611-16 614-16	503-16 ²	
K31-602-8	CL31-602-8 ⁷	RPR1428-16 ³⁵	851-16 8931-16	431M	2120 ³³ 3120	1431-16 ^{35,56} 1631-16 ¹	7819-16 7754-16	986-16 ² 26986-16 ²	740-16 795-16	611-16 614-16	503-16 ²	
MAGNUM Mechanical Flat Tappet Camshafts												
K31-333-4	CL31-333-4 ⁷	RPM1431-16 ^{35,39}	833-16 817-16	35200 35100	2120 ³³ 3120	1431-16 ^{35,56} 1631-16 ¹	7631-16 ³⁶ 7929-16	942-16 972-16	747-16 740-16	611-16	502-16	
K31-334-4	CL31-334-4 ⁷	RPM1431-16 ^{35,39}	833-16 817-16	35200 35100	2120 ³³ 3120	1431-16 ^{35,56} 1631-16 ¹	7631-16 ³⁶ 7929-16	942-16 972-16	747-16 740-16	611-16	502-16	
K31-335-4	CL31-335-4 ⁷	RPM1431-16 ^{35,39}	833-16 817-16	35200 35100	2120 ³³ 3120	1431-16 ^{35,56} 1631-16 ¹	7631-16 ³⁶ 7929-16	986-16 ² 26986-16	740-16 795-16	611-16 614-16	502-16	
K31-336-4	CL31-336-4 ⁷	RPM1431-16 ^{35,39}	833-16 817-16	35200 35100	2120 ³³ 3120	1431-16 ^{35,56} 1631-16 ¹	7631-16 ³⁶ 7929-16	986-16 ² 26986-16	740-16 795-16	611-16 614-16	502-16	
NOSTALGIA PLUS™ Mechanical Flat Tappet Camshaft												
K31-671-4	CL31-671-4 ⁷	RPM1431-16 ^{35,39}	833-16 817-16	35200 35100	2120 ³³ 3120	1431-16 ^{35,56} 1631-16 ¹	7631-16 ³⁶ 7929-16	972-16	747-16 730-16	611-16	502-16	
LIFTERS	TIMING SET	ROCKER ARMS	PUSHRODS	VALVE SPRINGS	RETAINERS	VALVE LOCKS	VALVE SEALS	LASH CAPS	REV KIT	DIST. GEAR	STUD GIRDLES	
FACTORY MUSCLE™ Mechanical Flat Tappet Camshaft (Today's Version Of Yesterday's Muscle Car Cams)												
833-16 817-16	2120 ³³ 3120	1431-16 ^{35,56} 1631-16 ¹	7929-16	26915-16	743-16	601-16	502-16	N/A	N/A	35200 35100	4013 ¹	
MAGNUM MUSCLE Mechanical Flat Tappet Camshaft (Today's Version Of Yesterday's Muscle Car Cams)												
833-16 817-16	2120 ³³ 3120	1431-16 ^{35,56} 1631-16 ¹	7929-16	972-16	743-16	601-16	502-16	N/A	N/A	35200 35100	4013 ¹	
DRAG RACE Mechanical Flat Tappet Camshaft												
833-16 817-16	2120 ³³ 3120	1431-16 ^{35,56} 1631-16 ¹	7929-16	985-16 ² 950-16 ²	740-16 730-16	611-16	503-16	621-16	N/A	35200 35100	4013 ¹	
833-16 817-16	2120 ³³ 3120	1431-16 ^{35,56} 1631-16 ¹	7929-16	985-16 ² 950-16 ²	740-16 730-16	611-16	503-16	621-16	N/A	35200 35100	4013 ¹	
833-16 817-16	2120 ³³ 3120	1431-16 ^{35,56} 1631-16 ¹	7929-16	985-16 ² 950-16 ²	740-16 730-16	611-16	503-16	621-16	N/A	35200 35100	4013 ¹	
833-16 817-16	2120 ³³ 3120	1431-16 ^{35,56} 1631-16 ¹	7929-16	985-16 ² 950-16 ²	740-16 730-16	611-16	503-16	621-16	N/A	35200 35100	4013 ¹	

³⁹ For 1.7:1 ratio use Part #RPM1453-16
⁵⁶ If equipped w/ studs & guide plates, use Part #1442-16

RED NUMBERS DENOTE PREMIUM OPTION



FORD 221-302 C.I. 8 CYL. 1963-1995 (INCLUDES 221, 260, 289 & 302) (CONTINUED)

APPLICATIONS/CAMSHAFTS	VALVE SETTING		RPM OPERATING RANGE	CAM PART #	CAM GRIND #	DURATION				VALVE LIFT		LOBE SEP. ANGLE
	IN. EX.					ADVERTISED		@ .050"		W/ 1.6 ROCKER		
	IN.	EX.				IN.	EX.	IN.	EX.	IN.	EX.	
MAGNUM Mechanical Roller Camshafts												
MECHANICAL ROLLER – Broad power, lower gear ratio, 2500+ stall with headers. Rough idle.	.020	.020	2200 to 6500	31-760-8	288R	288	288	243	243	.586	.586	110°
MECHANICAL ROLLER – Ultimate in Pro Street. 3500+ stall, 4.10 or lower gear. Radical idle.	.020	.020	3000 to 7000	31-761-8	308R	308	308	262	262	.613	.613	110°
DRAG RACE Mechanical Roller Camshafts												
MECHANICAL ROLLER – Excellent torque in 11:1 compression engines with 4000+ stall.	.026	.028	4200 to 7200	31-767-9⁵	296BR-6	296	304	260	268	.672	.672	106°
MECHANICAL ROLLER – Easy on parts, great automatic cam, must have 4500+ stall.	.026	.028	4500 to 7500	31-768-9⁵	306AR-4	306	306	271	271	.640	.640	104°

FORD 5.0L 8 CYL. 1985-2002

APPLICATIONS/CAMSHAFTS	VALVE SETTING		RPM OPERATING RANGE	CAM PART #	CAM GRIND #	DURATION				VALVE LIFT		LOBE SEP. ANGLE
	IN. EX.					ADVERTISED		@ .050"		W/ 1.6 ROCKER		
	IN.	EX.				IN.	EX.	IN.	EX.	IN.	EX.	
MAGNUM Hydraulic Roller Camshafts (CARBURETOR ONLY)												
1985-95 Engines Originally Equipped W/ Hydraulic Roller Cams												
HYDRAULIC ROLLER – Best with stock or slightly modified engine for economy or towing. Stock gears and torque converter. Smooth idle.	Hyd.	Hyd.	1200 to 4500	35-410-8	260HR	260	260	206	206	.533	.533	110°
HYDRAULIC ROLLER – Mild street performance. Slight lobe at idle. Stock converter ok but best with 1800+ stall. Needs lower gears.	Hyd.	Hyd.	1800 to 5000	35-420-8	270HR	270	270	215	215	.533	.533	110°
HYDRAULIC ROLLER – Great in street machines. Best power above 3500 RPM but still good torque. Mild rough idle. Largest for stock heads and intake. 2000+ stall recommended.	Hyd.	Hyd.	2000 to 5500	35-440-8	281HR	281	281	220	220	.512	.512	110°
HYDRAULIC ROLLER – Street machine and limited high performance street use. Best with 5 speed or 2200-2500 stall. 3.40 to 4.10 gears, aftermarket intake and headers.	Hyd.	Hyd.	2500 to 6000	35-430-8	280HR	280	280	224	224	.560	.560	110°
HYDRAULIC ROLLER – Street/strip applications. 5 speed or 2500+ stall, 4.10 or lower gears with higher compression. Aftermarket intake and exhaust.	Hyd.	Hyd.	3000 to 6500	35-450-8	286HR	286	286	230	230	.598	.598	110°

¹ Requires screw-in studs & guide plates
² Requires machining on cylinder heads
⁵ Requires distributor gear upgrade

⁶ Offset lifters available
⁷ Stock springs cannot be used
³⁵ Part #4504 studs required for 1978-present

³⁶ 1962-69 use Part #7632-16
⁵⁶ If equipped with studs and guide plates, use Part #1442-16

FORD 221-302 C.I. 8 CYL. 1963-1995 (INCLUDES 221, 260, 289 & 302) (CONTINUED)

K-KIT	SK-KIT	CL-KIT	LIFTERS	DIST. GEAR	TIMING SET	ROCKER ARMS	PUSHRODS	VALVE SPRINGS	STEEL RETAINERS	VALVE LOCKS	VALVE SEALS
MAGNUM Mechanical Roller Camshafts											
K31-760-8	SK31-760-8	CL31-760-8	838-16 ⁶	431M	2120 3120	1631-16 ¹ 1831-16 ¹	7631-16 ³⁶ 7929-16	914-16 ² 977-16 ²	741-16 740-16	611-16	503-16 ²
K31-761-8	SK31-761-8	CL31-761-8	838-16 ⁶	431M	2120 3120	1631-16 ¹ 1831-16 ¹	7631-16 ³⁶ 7929-16	914-16 ² 977-16 ²	741-16 740-16	611-16	503-16 ²
LIFTERS	TIMING SET	ROCKER ARMS	PUSHRODS	VALVE SPRINGS	RETAINERS	VALVE LOCKS	VALVE SEALS	LASH CAPS	REV KIT	DIST. GEAR	STUD GIRDLES
DRAG RACE Mechanical Roller Camshafts											
838-16 ⁶	3120	1632-16 ¹ 1832-16 ¹	7930-16	944-16 ²	731-16 720-16	611-16	503-16 ²	621-16	N/A	35200 35100	4014 ¹
838-16 ⁶	3120	1632-16 ¹ 1832-16 ¹	7930-16	944-16 ²	731-16 720-16	611-16	503-16 ²	621-16	N/A	35200 35100	4014 ¹

FORD 5.0L 8 CYL. 1985-2002

K-KIT	SK-KIT	CL-KIT	LIFTERS	DIST. GEAR	TIMING SET	ROCKER ARMS	PUSHRODS	VALVE SPRINGS	RETAINERS	VALVE LOCKS	VALVE SEALS
MAGNUM Hydraulic Roller Camshafts (CARBURETOR ONLY)											
K35-410-8	SK35-410-8 ⁷	CL35-410-8 ⁷	851-16 8931-16	431M	2138 ⁷⁰ 3138 ⁷⁰	1431-16 ^{35,56} 1631-16 ¹	7826-16 7917-16	986-16 ² 26986-16	740-16 795-16	611-16 614-16	503-16 ²
K35-420-8	SK35-420-8 ⁷	CL35-420-8 ⁷	851-16 8931-16	431M	2138 ⁷⁰ 3138 ⁷⁰	1431-16 ^{35,56} 1631-16 ¹	7826-16 7917-16	986-16 ² 26986-16	740-16 795-16	611-16 614-16	503-16 ²
K35-440-8	SK35-440-8 ⁷	CL35-440-8 ⁷	851-16 8931-16	431M	2138 ⁷⁰ 3138 ⁷⁰	1431-16 ^{35,56} 1631-16 ¹	7826-16 7917-16	986-16 ² 26986-16	740-16 795-16	611-16 614-16	503-16 ²
K35-430-8	SK35-430-8 ⁷	CL35-430-8 ⁷	851-16 8931-16	431M	2138 ⁷⁰ 3138 ⁷⁰	1431-16 ^{35,56} 1631-16 ¹	7826-16 7917-16	987-16 ² 26986-16	740-16 795-16	611-16 614-16	503-16 ²
K35-450-8	SK35-450-8 ⁷	CL35-450-8 ⁷	851-16 8931-16	431M	2138 ⁷⁰ 3138 ⁷⁰	1431-16 ^{35,56} 1631-16 ¹	7826-16 7917-16	987-16 ² 26986-16	740-16 795-16	611-16 614-16	503-16 ²

⁷⁰ Works with two-piece fuel pump eccentric

FORD 5.0L 8 CYL. 1985-2002 (CONTINUED)

APPLICATIONS/CAMSHAFTS	VALVE SETTING		RPM OPERATING RANGE	CAM PART #	CAM GRIND #	DURATION				VALVE LIFT		LOBE SEP. ANGLE
	IN.	EX.				IN.	EX.	IN.	EX.	IN.	EX.	
MAGNUM Computer Controlled Hydraulic Roller Camshafts (FOR EFI)												
1985-95 Engines Originally Equipped W/ Hydraulic Roller Cams												
HYDRAULIC ROLLER – Good stock upgrade. Best with mild tuning.	Hyd.	Hyd.	1200 to 5200	35-308-8	266HR	266	270	210	215	.533	.533	114°
HYDRAULIC ROLLER – Mild modifications, gears, mass air. Has slight idle.	Hyd.	Hyd.	1500 to 5500	35-310-8	270HR	270	276	215	220	.533	.544	114°
HYDRAULIC ROLLER – Mass air, 5 speed or 2500+ stall, heads, intake, headers, 3.55-3.73 gears.	Hyd.	Hyd.	2000 to 5500	35-302-8	281HR	281	284	220	224	.512	.533	112°
HYDRAULIC ROLLER – Works well with 5 speed or 2500+ stall, likes good intake, mass air and injectors.	Hyd.	Hyd.	2000 to 6000	35-312-8	276HR	276	280	220	224	.544	.560	114°
HYDRAULIC ROLLER – Needs injectors, larger mass air and throttle body, intake, heads, headers, gears and 2500+ stall or 5 speed.	Hyd.	Hyd.	2200 to 6200	35-314-8	280HR	280	286	224	230	.560	.598	112°
XTREME FUEL INJECTION (XFI™) Computer Controlled Hydraulic Roller Camshafts												
1985-95 Engines O.E. Hydraulic Roller												
HYDRAULIC ROLLER – 347c.i. or larger. Super strong mid-range. Best w/ 9.5:1+ compression, aftermarket heads, intake, T-body and injectors. 3000+ stall or 5 speed. Computer mods a must.	Hyd.	Hyd.	2600 to 6300	35-775-8⁷	XFI236HR-14	286	300	236	248	.579	.579	114°
HYDRAULIC ROLLER – 347c.i. or larger. Serious hp and torque in mid and upper RPM. Best w/ aftermarket heads, intake, T-body and injectors. 3500+ stall or 5 speed. Computer mods a must.	Hyd.	Hyd.	3200 to 6500	35-776-8⁷	XFI248HR-14	304	314	248	258	.608	.608	114°
XTREME ENERGY™ Computer Controlled Hydraulic Roller Camshafts (FOR EFI)												
1985-95 Engines Originally Equipped w/ Hydraulic Roller Cams												
HYDRAULIC ROLLER – Good power in stock application with few modifications. Best for towing or economy.	Hyd.	Hyd.	1200 to 5200	35-512-8	XE258HR	258	264	206	212	.480	.480	114°
HYDRAULIC ROLLER – Mild street performance, good upgrade for stock cam. Works with O.B.D.1	Hyd.	Hyd.	1500 to 5500	35-349-8	XE264HR	264	270	212	218	.512	.512	114°
HYDRAULIC ROLLER – Best when used with better heads, intake, exhaust and 3.55-3.73 gears.	Hyd.	Hyd.	1800 to 5800	35-351-8	XE270HR	270	276	218	224	.512	.512	114°
HYDRAULIC ROLLER – For stock H.O. or with mild modifications.	Hyd.	Hyd.	1300 to 5300	35-510-8	XE258HR	258	266	208	216	.533	.544	112°
HYDRAULIC ROLLER – Mild modifications, 3.27-3.73 gears, mass air, larger throttle body.	Hyd.	Hyd.	1600 to 5600	35-514-8	XE266HR	266	274	216	224	.544	.555	112°
HYDRAULIC ROLLER – 2500+ stall, 3.55-3.73 gears, better heads, intake and fuel system.	Hyd.	Hyd.	2200 to 6200	35-518-8	XE274HR	274	282	224	232	.555	.565	112°
HYDRAULIC ROLLER – Street/strip, needs EEC IV upgrade, heads, intake and gears. 2800+ stall.	Hyd.	Hyd.	2600 to 6500	35-522-8	XE282HR	282	290	232	240	.565	.574	112°

¹ Requires screw-in studs & guide plates
² Requires machining on cylinder heads

⁷ Stock springs cannot be used
³⁵ Part #4504 studs required for 1978-present

⁵⁶ If equipped with studs and guide plates, use Part #1442-16

FORD 5.0L 8 CYL. 1985-2002 (CONTINUED)

K-KIT	SK-KIT	CL-KIT	LIFTERS	DIST. GEAR	TIMING SET	ROCKER ARMS	PUSHRODS	VALVE SPRINGS	STEEL RETAINERS	VALVE LOCKS	VALVE SEALS	
MAGNUM Computer Controlled Hydraulic Roller Camshafts (FOR EFI)												
K35-308-8	SK35-308-8 ⁷	CL35-308-8 ⁷	851-16 8931-16	431M	2138 ⁷⁰ 3138 ⁷⁰	1431-16 ^{35,56} 1631-16 ¹	7826-16 7917-16	986-16 ² 26986-16	740-16 795-16	611-16 614-16	503-16 ²	
K35-310-8	SK35-310-8 ⁷	CL35-310-8 ⁷	851-16 8931-16	431M	2138 ⁷⁰ 3138 ⁷⁰	1431-16 ^{35,56} 1631-16 ¹	7826-16 7917-16	986-16 ² 26986-16	740-16 795-16	611-16 614-16	503-16 ²	
K35-302-8	SK35-302-8 ⁷	CL35-302-8 ⁷	851-16 8931-16	431M	2138 ⁷⁰ 3138 ⁷⁰	1431-16 ^{35,56} 1631-16 ¹	7826-16 7917-16	986-16 ² 26986-16	740-16 795-16	611-16 614-16	503-16 ²	
K35-312-8	SK35-312-8 ⁷	CL35-312-8 ⁷	851-16 8931-16	431M	2138 ⁷⁰ 3138 ⁷⁰	1431-16 ^{35,56} 1631-16 ¹	7826-16 7917-16	987-16 ² 26986-16	740-16 795-16	611-16 614-16	503-16 ²	
K35-314-8	SK35-314-8 ⁷	CL35-314-8 ⁷	851-16 8931-16	431M	2138 ⁷⁰ 3138 ⁷⁰	1431-16 ^{35,56} 1631-16 ¹	7826-16 7917-16	987-16 ² 26986-16	740-16 795-16	611-16 614-16	503-16 ²	

LIFTERS	TIMING SET	ROCKER ARMS	PUSHRODS	VALVE SPRINGS	RETAINERS	VALVE LOCKS	VALVE SEALS	LASH CAPS	REV KIT	DIST. GEAR	STUD GIRDLES
XTREME FUEL INJECTION (XFI™) Computer Controlled Hydraulic Roller Camshafts											
851-16 8931-16	2138 ⁷⁰ 3138 ⁷⁰	1431-16 ^{35,56} 1631-16 ¹	7826-16 7917-16	987-16 ² 26986-16	740-16 795-16	611-16 614-16	503-16 ²	621-16	N/A	431M	4013
851-16 8931-16	2138 ⁷⁰ 3138 ⁷⁰	1431-16 ^{35,56} 1631-16 ¹	7826-16 7917-16	914-16 ² 26986-16	740-16 795-16	611-16 614-16	503-16 ²	621-16	N/A	431M	4013

K-KIT	SK-KIT	CL-KIT	LIFTERS	DIST. GEAR	TIMING SET	ROCKER ARMS	PUSHRODS	VALVE SPRINGS	RETAINERS	VALVE LOCKS	VALVE SEALS
XTREME ENERGY™ Computer Controlled Hydraulic Roller Camshafts (FOR EFI)											
K35-512-8	SK35-512-8	CL35-512-8	851-16 8931-16	431M	2138 ⁷⁰ 3138 ⁷⁰	1431-16 ^{35,56} 1631-16 ¹	7826-16 7917-16	942-16 986-16 ²	768-16 740-16	601-16 611-16	502-16 503-16 ²
K35-349-8	SK35-349-8 ⁷	CL35-349-8 ⁷	851-16 8931-16	431M	2138 ⁷⁰ 3138 ⁷⁰	1431-16 ^{35,56} 1631-16 ¹	7826-16 7917-16	986-16 ² 26986-16	768-16 740-16	611-16 614-16	503-16 ²
K35-351-8	SK35-351-8 ⁷	CL35-351-8 ⁷	851-16 8931-16	431M	2138 ⁷⁰ 3138 ⁷⁰	1431-16 ^{35,56} 1631-16 ¹	7826-16 7917-16	986-16 ² 26986-16	768-16 740-16	611-16 614-16	503-16 ²
K35-510-8	SK35-510-8 ⁷	CL35-510-8 ⁷	851-16 8931-16	431M	2138 ⁷⁰ 3138 ⁷⁰	1431-16 ^{35,56} 1631-16 ¹	7826-16 7917-16	986-16 ² 26986-16	768-16 740-16	611-16 614-16	503-16 ²
K35-514-8	SK35-514-8 ⁷	CL35-514-8 ⁷	851-16 8931-16	431M	2138 ⁷⁰ 3138 ⁷⁰	1431-16 ^{35,56} 1631-16 ¹	7826-16 7917-16	986-16 ² 26986-16	768-16 740-16	611-16 614-16	503-16 ²
K35-518-8	SK35-518-8 ⁷	CL35-518-8 ⁷	851-16 8931-16	431M	2138 ⁷⁰ 3138 ⁷⁰	1431-16 ^{35,56} 1631-16 ¹	7826-16 7917-16	986-16 ² 26986-16	768-16 740-16	611-16 614-16	503-16 ²
K35-522-8	SK35-522-8 ⁷	CL35-522-8 ⁷	851-16 8931-16	431M	2138 ⁷⁰ 3138 ⁷⁰	1431-16 ^{35,56} 1631-16 ¹	7826-16 7917-16	986-16 ² 26986-16	768-16 740-16	611-16 614-16	503-16 ²

⁷⁰ Works with two-piece fuel pump eccentric

FORD 5.0L 8 CYL. 1985-2002 (CONTINUED)

APPLICATIONS/CAMSHAFTS	VALVE SETTING		RPM OPERATING RANGE	CAM PART #	CAM GRIND #	DURATION				VALVE LIFT		LOBE SEP. ANGLE
	IN.	EX.				ADVERTISED IN.	EX.	@ .050" IN.	EX.	W/ 1.6 ROCKER IN.	EX.	
NITROUS HP™ Hydraulic Roller Camshafts (CARBURETED OR EFI)												
1985-95 Engines Originally Equipped W/ Hydraulic Roller Cams												
HYDRAULIC ROLLER – High performance street with 75-125 HP nitrous kit or small blower. Mild idle.	Hyd.	Hyd.	1500 to 5600	35-552-8	NX264HR	264	276	212	224	.512	.512	114°
HYDRAULIC ROLLER – Street/strip applications, 100-175 HP kit or medium blower, rough idle.	Hyd.	Hyd.	2200 to 6200	35-556-8	NX274HR	274	286	224	236	.555	.570	114°
HYDRAULIC ROLLER – Pro Street applications, excellent for 150-300 HP kits or large blower, computer modifications required.	Hyd.	Hyd.	2600 to 6600	35-560-8	NX282HR	282	294	232	244	.565	.580	114°
BLOWER Hydraulic Roller Camshafts (CARBURETED OR EFI)												
1985-95 Engines Originally Equipped W/ Hydraulic Roller Cams												
HYDRAULIC ROLLER – Supercharged combinations with little or no additional modifications.	Hyd.	Hyd.	1800 to 5300	35-304-8	270HR	270	284	215	224	.533	.533	114°
HYDRAULIC ROLLER – Supercharged, works well with 5 speed, needs good intake with mass air and larger injectors, mild stall.	Hyd.	Hyd.	2000 to 6000	35-312-8	276HR	276	280	220	224	.544	.560	114°
HYDRAULIC ROLLER – Supercharged combinations with heads, intake, headers, 3.55-3.73 gear, mild stall.	Hyd.	Hyd.	2000 to 6000	35-306-8	284HR	284	290	224	230	.533	.544	114°
XTREME ENERGY™ Computer Controlled Hydraulic Roller Camshafts (FOR EFI)												
1985-95 Engines O.E. w/ Hydraulic Roller Cams (WITH 1.7 ROCKERS)												
HYDRAULIC ROLLER – For use with 1.7:1 rockers. Mild street performance, good upgrade for factory cam.	Hyd.	Hyd.	1500 to 5500	35-320-8	XE264HR	264	270	212	218	.544	.544	112°
HYDRAULIC ROLLER – For use with 1.7:1 rockers. Mild modifications, 3.20-3.73 gears, larger throttle body and mass air, good heads and manifold.	Hyd.	Hyd.	1800 to 5800	35-324-8	XE270HR	270	276	218	224	.544	.544	112°
HYDRAULIC ROLLER – For use with 1.7:1 rockers. Major modifications, 3.55 gear or lower, 2500+ stall.	Hyd.	Hyd.	2200 to 6200	35-328-8	XE276HR	276	282	224	230	.544	.544	112°
STREET/STRIP EFI Hydraulic Roller Camshafts												
HYDRAULIC ROLLER – 306-347c.i. with 160-180cc head, 9.25:1-10:1 compression. Needs intake upgrade, tuning required.	Hyd.	Hyd.	2500 to 6000	35-870-13	277DHR-11	277	290	227	238	.577	.579	111°
HYDRAULIC ROLLER – 331-363c.i. with 190-215cc head, 10:1-11:1 compression. Needs aftermarket intake, requires tuning.	Hyd.	Hyd.	2800 to 6200	35-870-13	289DHR-12	289	301	237	247	.632	.619	112°
HYDRAULIC ROLLER – 375-434c.i. with 200-225cc head, 10:1-11:1 compression. Needs single plane intake, requires tuning.	Hyd.	Hyd.	3000 to 6500	35-870-13	295DHR-12	295	307	243	253	.638	.622	112°

¹ Requires screw-in studs & guide plates
² Requires machining on cylinder heads

⁷ Stock springs cannot be used
³⁵ Part #4504 studs required for 1978-present

⁵⁶ If equipped with studs and guide plates, use Part #1442-16

FORD 5.0L 8 CYL. 1985-2002 (CONTINUED)

NITROUS HP™ Hydraulic Roller Camshafts (CARBURETED OR EFI)

K-KIT	SK-KIT	CL-KIT	LIFTERS	DIST. GEAR	TIMING SET	ROCKER ARMS	PUSHRODS	VALVE SPRINGS	RETAINERS	VALVE LOCKS	VALVE SEALS
K35-552-8	SK35-552-8 ⁷	CL35-552-8 ⁷	851-16 8931-16	431M	2138 ⁷⁰ 3138 ⁷⁰	1431-16 ^{35,56} 1631-16 ¹	7826-16 7917-16	986-16 ² 26986-16	740-16 795-16	611-16 614-16	503-16 ²
K35-556-8	SK35-556-8 ⁷	CL35-556-8 ⁷	851-16 8931-16	431M	2138 ⁷⁰ 3138 ⁷⁰	1431-16 ^{35,56} 1631-16 ¹	7826-16 7917-16	987-16 ² 26986-16	740-16 795-16	611-16 614-16	503-16 ²
K35-560-8	SK35-560-8 ⁷	CL35-560-8 ⁷	851-16 8931-16	431M	2138 ⁷⁰ 3138 ⁷⁰	1431-16 ^{35,56} 1631-16 ¹	7826-16 7917-16	987-16 ² 26986-16	740-16 795-16	611-16 614-16	503-16 ²

BLOWER Hydraulic Roller Camshafts (CARBURETED OR EFI)

K35-304-8	SK35-304-8	CL35-304-8	851-16 8931-16	431M	2138 ⁷⁰ 3138 ⁷⁰	1431-16 ^{35,56} 1631-16 ¹	7826-16 7917-16	986-16 ² 26986-16	740-16 795-16	611-16 614-16	503-16 ²
K35-312-8	SK35-312-8	CL35-312-8	851-16 8931-16	431M	2138 ⁷⁰ 3138 ⁷⁰	1431-16 ^{35,56} 1631-16 ¹	7826-16 7917-16	987-16 ² 26986-16	740-16 795-16	611-16 614-16	503-16 ²
K35-306-8	SK35-306-8	CL35-306-8	851-16 8931-16	431M	2138 ⁷⁰ 3138 ⁷⁰	1431-16 ^{35,56} 1631-16 ¹	7826-16 7917-16	986-16 ² 26986-16	740-16 795-16	611-16 614-16	503-16 ²

XTREME ENERGY™ Computer Controlled Hydraulic Roller Camshafts (FOR EFI)

K35-320-8	SK35-320-8	CL35-320-8	851-16 8931-16	431M	2138 ⁷⁰ 3138 ⁷⁰	1431-16 ^{35,56} 1631-16 ¹	7826-16 7917-16	986-16 ² 26986-16	740-16 795-16	611-16 614-16	503-16 ²
K35-324-8	SK35-324-8	CL35-324-8	851-16 8931-16	431M	2138 ⁷⁰ 3138 ⁷⁰	1431-16 ^{35,56} 1631-16 ¹	7826-16 7917-16	986-16 ² 26986-16	740-16 795-16	611-16 614-16	503-16 ²
K35-328-8	SK35-328-8	CL35-328-8	851-16 8931-16	431M	2138 ⁷⁰ 3138 ⁷⁰	1431-16 ^{35,56} 1631-16 ¹	7826-16 7917-16	986-16 ² 26986-16	740-16 795-16	611-16 614-16	503-16 ²

STREET/STRIP EFI Hydraulic Roller Camshafts

LIFTERS	TIMING SET	ROCKER ARMS	PUSHRODS	VALVE SPRINGS	RETAINERS	VALVE LOCKS	VALVE SEALS	LASH CAPS	REV KIT	DIST. GEAR	STUD GIRDLES
877-16 15931-16	3135	1632-16 ¹ 1832-16 ¹	N/A	914-16 ²	1731-16 731-16	611-16 614-16	503-16 ²	621-16	N/A	431M	4013
877-16 15931-16	3135	1632-16 ¹ 1832-16 ¹	N/A	914-16 ²	1731-16 731-16	611-16 614-16	503-16 ²	621-16	N/A	431M	4013
15931-16	3135	1632-16 ¹ 1832-16 ¹	N/A	914-16 ²	1731-16 731-16	611-16 614-16	503-16 ²	621-16	N/A	431M	4013

⁷⁰ Works with two-piece fuel pump eccentric

FORD 351W 8 CYL. 1969-1996

APPLICATIONS/CAMSHAFTS	VALVE SETTING		RPM OPERATING RANGE	CAM PART #	CAM GRIND #	DURATION				VALVE LIFT		LOBE SEP. ANGLE
	IN.	EX.				IN.	EX.	IN.	EX.	IN.	EX.	
HIGH ENERGY™ Hydraulic Flat Tappet Camshafts												
HYDRAULIC – Strong torque and good mileage in low RPM applications. Performance upgrade for stock cam. Smooth idle.	Hyd.	Hyd.	800 to 4800	35-215-3	252H	252	252	206	206	.433	.433	110°
HYDRAULIC – Great torque for trucks and 4WD. Best for economy or towing vehicles with automatic. Smooth idle.	Hyd.	Hyd.	1200 to 5200	35-216-3	260H	260	260	212	212	.447	.447	110°
HYDRAULIC – Moderate high performance street driving. Mild street machines, great for daily drivers. Noticeable idle.	Hyd.	Hyd.	1500 to 5500	35-218-3	268H	268	268	218	218	.456	.456	110°
MAGNUM Hydraulic Flat Tappet Camshafts												
HYDRAULIC – Good for daily driven performance cars. Largest cam for stock converter. Lower gears. Mild rough ride.	Hyd.	Hyd.	1800 to 5800	35-414-3	270H	270	270	224	224	.500	.500	110°
HYDRAULIC – Excellent street machine camshaft. Headers & 2200+ stall with low gears. Rough idle. 9:1 compression.	Hyd.	Hyd.	2000 to 6000	35-226-3	280H	280	280	230	230	.512	.512	110°
HYDRAULIC – Great street/strip cam. 10:1 compression, headers, intake, gears and 3000+ stall. Very rough idle.	Hyd.	Hyd.	2500 to 6500	35-330-3	292H	292	292	244	244	.518	.518	110°
HYDRAULIC – Ultimate cam for Pro Street. 3500+ stall with 10.5:1 compression and low gears. Radical idle.	Hyd.	Hyd.	3000 to 7000	35-331-4	305H	305	305	253	253	.540	.540	110°
XTREME ENERGY™ Hydraulic Flat Tappet Camshafts												
HYDRAULIC – Very strong torque, excellent mileage, smooth idle.	Hyd.	Hyd.	600 to 4800	35-230-3	XE250H	250	260	206	212	.461	.474	110°
HYDRAULIC – Strong torque through low end and mid-range, good idle.	Hyd.	Hyd.	1000 to 5200	35-234-3	XE256H	256	262	212	218	.477	.484	110°
HYDRAULIC – Excellent response, good mid-range, stock converter, 3.23-4.10 gear.	Hyd.	Hyd.	1300 to 5600	35-238-3	XE262H	262	270	218	224	.493	.500	110°
HYDRAULIC – Great for street machine, 2200+ stall.	Hyd.	Hyd.	1600 to 5800	35-242-3	XE268H	268	280	224	230	.510	.512	110°
HYDRAULIC – Very strong torque and throttle response, 2500+ stall.	Hyd.	Hyd.	1800 to 6000	35-246-3	XE274H	274	286	230	236	.519	.523	110°
HYDRAULIC – Street/strip with 2800+ stall, headers, gears, rough idle.	Hyd.	Hyd.	2300 to 6500	35-250-4	XE284H	284	296	240	246	.541	.544	110°
HYDRAULIC – Pro Street/bracket, good intake, headers, gear, 3300+ stall.	Hyd.	Hyd.	2800 to 7000	35-254-4	XE294H	294	306	250	256	.554	.558	110°

¹ Requires screw-in studs & guide plates
² Requires machining on cylinder heads

⁷ Stock springs cannot be used
³³ Pre-1972 engines use Part #3220

³⁵ Part #4504 studs required for 1978-present
³⁷ Adjustable valve train required

FORD 351W 8 CYL. 1969-1996

CAMSHAFTS FORD

K-KIT	CL-KIT	RP-KIT	LIFTERS	DIST. GEAR	TIMING SET	ROCKER ARMS	PUSHRODS	VALVE SPRINGS	RETAINERS	VALVE LOCKS	VALVE SEALS	
HIGH ENERGY™ Hydraulic Flat Tappet Camshafts												
K35-215-3	CL35-215-3	RP1436-16 ³⁵	832-16	35200 35100	3230 ³³	1431-16 ^{35,56}	7835-16	942-16 972-16	768-16 747-16	601-16 611-16	502-16	
K35-216-3	CL35-216-3	RP1436-16 ³⁵	832-16	35200 35100	3230 ³³	1431-16 ^{35,56}	7835-16	942-16 972-16	768-16 747-16	601-16 611-16	502-16	
K35-218-3	CL35-218-3 ⁷	RP1436-16 ³⁵	832-16	35200 35100	3230 ³³	1431-16 ^{35,56}	7835-16	942-16 972-16	768-16 747-16	601-16 611-16	502-16	
MAGNUM Hydraulic Flat Tappet Camshafts												
K35-414-3	CL35-414-3 ⁷	RP1436-16 ³⁵	832-16 862-16 ³⁷	35200 35100	2135 3135	1431-16 ^{35,56} 1631-16	7472-16 7965-16	942-16 972-16	747-16 740-16	611-16	502-16	
K35-226-3	CL35-226-3 ⁷	RP1436-16 ³⁵	832-16 862-16 ³⁷	35200 35100	2135 3135	1431-16 ^{35,56} 1631-16 ¹	7472-16 7965-16	942-16 972-16	747-16 740-16	611-16	502-16	
K35-330-3	CL35-330-3 ⁷	RP1436-16 ³⁵	832-16 862-16 ³⁷	35200 35100	2135 3135	1431-16 ^{35,56} 1631-16 ¹	7472-16 7965-16	986-16 ² 26986-16	740-16 795-16	611-16 614-16	503-16 ²	
K35-331-4	CL35-331-4	RP1436-16 ³⁵	832-16 862-16 ³⁷	35200 35100	2135 3135	1431-16 ^{35,56} 1631-16 ¹	7472-16 7965-16	986-16 ² 26986-16	740-16 795-16	611-16 614-16	503-16 ²	
XTREME ENERGY™ Hydraulic Flat Tappet Camshafts												
K35-230-3	CL35-230-3 ⁷	RP1436-16 ³⁵	832-16 862-16 ³⁷	35200 35100	3230 ³³ 2135	1431-16 ^{35,56} 1631-16 ¹	7835-16 7472-16	942-16 972-16	768-16 743-16	601-16	502-16	
K35-234-3	CL35-234-3 ⁷	RP1436-16 ³⁵	832-16 862-16 ³⁷	35200 35100	3230 ³³ 2135	1431-16 ^{35,56} 1631-16 ¹	7835-16 7472-16	942-16 972-16	768-16 743-16	601-16	502-16	
K35-238-3	CL35-238-3 ⁷	RP1436-16 ³⁵	832-16 862-16 ³⁷	35200 35100	3230 ³³ 2135	1431-16 ^{35,56} 1631-16 ¹	7835-16 7472-16	942-16 972-16	768-16 743-16	601-16	502-16	
K35-242-3	CL35-242-3 ⁷	RP1436-16 ³⁵	832-16 862-16 ³⁷	35200 35100	3230 ³³ 2135	1431-16 ^{35,56} 1631-16 ¹	7835-16 7472-16	942-16 972-16	768-16 743-16	601-16	502-16	
K35-246-3	CL35-246-3 ⁷	RP1436-16 ³⁵	832-16 862-16 ³⁷	35200 35100	2135 3135	1431-16 ^{35,56} 1631-16 ¹	7472-16 7965-16	986-16 ² 26986-16	740-16 795-16	611-16 614-16	503-16 ²	
K35-250-4	CL35-250-4 ⁷	RP1436-16 ³⁵	832-16 862-16 ³⁷	35200 35100	2135 3135	1431-16 ^{35,56} 1631-16 ¹	7472-16 7965-16	986-16 ² 26986-16	740-16 795-16	611-16 614-16	503-16 ²	
K35-254-4	CL35-254-4 ⁷	RP1436-16 ³⁵	832-16 862-16 ³⁷	35200 35100	2135 3135	1431-16 ^{35,56} 1631-16 ¹	7472-16 7965-16	986-16 ² 26986-16	740-16 795-16	611-16 614-16	503-16 ²	

⁵⁶ If equipped with studs and guide plates, use Part #1442-16

FORD 351W 8 CYL. 1969-1996 (CONTINUED)

APPLICATIONS/CAMSHAFTS	VALVE SETTING		RPM OPERATING RANGE	CAM PART #	CAM GRIND #	DURATION				VALVE LIFT		LOBE SEP. ANGLE
	IN.	EX.				ADVERTISED IN.	EX.	@ .050"		W/ 1.6 ROCKER IN.	EX.	
								IN.	EX.			
THUMPR™ Hydraulic Flat Tappet Camshafts												
HYDRAULIC – Thumpr™ – High performance street, stock converter ok, best with 2000+ converter and gears. Choppy/thumping idle.	Hyd.	Hyd.	2000 to 5800	35-600-4	279TH7	279	297	227	241	.490	.475	107°
HYDRAULIC – Mutha' Thumpr™ – High performance street/strip, needs 9:1 compression, 2500+ stall, intake, gears and headers, rough idle.	Hyd.	Hyd.	2200 to 6100	35-601-4	287TH7	287	304	235	249	.501	.486	107°
HYDRAULIC – Big Mutha' Thumpr™ – Street/strip, needs 9.5:1 compression, 2800+ stall, intake, gears and headers, very rough idle.	Hyd.	Hyd.	2500 to 6400	35-602-4	295TH7	295	313	243	257	.512	.489	107°

APPLICATIONS/CAMSHAFTS	VALVE SETTING		RPM OPERATING RANGE	CAM PART #	CAM GRIND #	DURATION				VALVE LIFT		LOBE SEP. ANGLE
	IN.	EX.				ADVERTISED IN.	EX.	@ .050"		W/ 1.6 ROCKER IN.	EX.	
								IN.	EX.			
XTREME 4X4™ Hydraulic Flat Tappet Camshafts												
HYDRAULIC – Excellent torque and throttle response, good economy and low end power.	Hyd.	Hyd.	1000 to 5000	35-231-3	X4250H	250	258	206	214	.462	.493	111°
HYDRAULIC – Good torque for 4x4, excellent mid-range power, great for RV or towing.	Hyd.	Hyd.	1200 to 5200	35-235-3	X4254H	254	262	210	218	.477	.493	111°
HYDRAULIC – Good torque for 4x4 with aftermarket intake & headers. Excellent mid-range, works with lower gears.	Hyd.	Hyd.	1400 to 5500	35-239-3	X4262H	262	270	218	226	.493	.512	111°
HYDRAULIC – Good torque and throttle response, needs intake & headers, lower gears & 2500+ stall.	Hyd.	Hyd.	1600 to 5800	35-243-4	X4270H	270	278	226	234	.512	.531	111°

DUAL ENERGY™ Hydraulic Flat Tappet Camshafts												
HYDRAULIC – Good torque and mileage. Excellent high end horsepower. Smooth idle.	Hyd.	Hyd.	1000 to 5500	35-416-3	255DEH	255	263	203	216	.434	.467	110°
HYDRAULIC – Very strong mid-range. Everyday performance for stock exhaust.	Hyd.	Hyd.	1500 to 5750	35-409-3	265DEH	265	273	211	223	.472	.486	110°
HYDRAULIC – High performance. Great high end power. Works with stock converter or 1800+ stall. Choppy idle.	Hyd.	Hyd.	2000 to 6000	35-418-3	275DEH	275	283	219	233	.477	.510	110°

XTREME ENERGY™ Computer Controlled Hydraulic Flat Tappet Camshaft (FOR EFI)												
HYDRAULIC – EFI speed density, works with stock computer. Very strong torque, excellent mileage, good idle quality.	Hyd.	Hyd.	1000 to 5200	35-255-5	XE254H	254	258	210	214	.478	.485	114°

APPLICATIONS/CAMSHAFTS	VALVE SETTING		RPM OPERATING RANGE	CAM PART #	CAM GRIND #	DURATION				VALVE LIFT		LOBE SEP. ANGLE
	IN.	EX.				ADVERTISED IN.	EX.	@ .050"		W/ 1.6 ROCKER IN.	EX.	
								IN.	EX.			
LOW LIFT OVAL TRACK Hydraulic Flat Tappet Camshaft												
HYDRAULIC – .450" lift rule. Rough idle, under 10" of vacuum. Good power.	Hyd.	Hyd.	3000 to 6500	35-635-5	41/15H-6	297	299	246	250	.448	.448	106°

¹ Requires screw-in studs & guide plates
² Requires machining on cylinder heads
⁷ Stock springs cannot be used

³³ Pre-1972 engines use Part #3220
³⁵ Part #4504 studs required for 1978-present
³⁷ Adjustable valve train required

⁵⁰ Camshaft retaining plate Part #3120TB recommended

FORD 351W 8 CYL. 1969-1996 (CONTINUED)

CAMSHAFTS FORD

K-KIT	GK-KIT	CL-KIT	LIFTERS	TIMING SET	GEAR DRIVE	ROCKER ARMS	PUSHRODS	VALVE SPRINGS	RETAINERS	VALVE LOCKS	VALVE SEALS
THUMPR™ Hydraulic Flat Tappet Camshafts											
K35-600-4	GK35-600-4 ^{7,93}	CL35-600-4 ⁷	832-16 862-16 ³⁷	2135 3135	4120	1431-16 ^{35,56} 1631-16 ¹	7472-16 7965-16	942-16 972-16	768-16 743-16	601-16	502-16
K35-601-4	GK35-601-4 ^{7,93}	CL35-601-4 ⁷	832-16 862-16 ³⁷	2135 3135	4120	1431-16 ^{35,56} 1631-16 ¹	7472-16 7965-16	986-16 ² 26986-16	740-16 795-16	611-16 614-16	503-16 ²
K35-602-4	GK35-602-4 ^{7,93}	CL35-602-4 ⁷	832-16 862-16 ³⁷	2135 3135	4120	1431-16 ^{35,56} 1631-16 ¹	7472-16 7965-16	986-16 ² 26986-16	740-16 795-16	611-16 614-16	503-16 ²
K-KIT	CL-KIT	RP-KIT	LIFTERS	DIST. GEAR	TIMING SET	ROCKER ARMS	PUSHRODS	VALVE SPRINGS	RETAINERS	VALVE LOCKS	VALVE SEALS
XTREME 4X4™ Hydraulic Flat Tappet Camshafts											
K35-231-3	CL35-231-3 ⁷	RP1436-16 ³⁵	832-16 862-16 ³⁷	35200 35100	2135 3135	1431-16 ^{35,56} 1631-16 ¹	7835-16 7472-16	942-16 972-16	768-16 743-16	601-16	502-16
K35-235-3	CL35-235-3 ⁷	RP1436-16 ³⁵	832-16 862-16 ³⁷	35200 35100	2135 3135	1431-16 ^{35,56} 1631-16 ¹	7835-16	942-16 972-16	768-16 743-16	601-16	502-16
K35-239-3	CL35-239-3 ⁷	RP1436-16 ³⁵	832-16 862-16 ³⁷	35200 35100	2135 3135	1431-16 ^{35,56} 1631-16 ¹	7472-16 7965-16	986-16 ² 26986-16	740-16 795-16	611-16 614-16	503-16 ²
K35-243-4	CL35-243-4 ⁷	RP1436-16 ³⁵	832-16 862-16 ³⁷	35200 35100	2135 3135	1431-16 ^{35,56} 1631-16 ¹	7472-16 7965-16	986-16 ² 26986-16	740-16 795-16	611-16 614-16	503-16 ²
DUAL ENERGY™ Hydraulic Flat Tappet Camshafts											
K35-416-3	CL35-416-3 ⁷	RP1436-16 ³⁵	832-16	35200 35100	3230 ⁹³	1431-16 ^{35,56}	7835-16	942-16 972-16	768-16 747-16	601-16 611-16	502-16
K35-409-3	CL35-409-3 ⁷	RP1436-16 ³⁵	832-16	35200 35100	3230 ⁹³	1431-16 ^{35,56}	7835-16	942-16 972-16	768-16 747-16	601-16 611-16	502-16
K35-418-3	CL35-418-3 ⁷	RP1436-16 ³⁵	832-16	35200 35100	3230 ⁹³	1431-16 ^{35,56}	7835-16	942-16 972-16	768-16 747-16	601-16 611-16	502-16
XTREME ENERGY™ Computer Controlled Hydraulic Flat Tappet Camshaft (FOR EFI)											
N/A	N/A	RP1436-16 ³⁵	832-16	35200 35100	3230 ⁹³	1431-16 ^{35,56}	7835-16	942-16 972-16	768-16 747-16	601-16 611-16	502-16
LIFTERS	TIMING SET	ROCKER ARMS	PUSHRODS	VALVE SPRINGS	RETAINERS	VALVE LOCKS	VALVE SEALS	LASH CAPS	REV KIT	DIST. GEAR	STUD GIRDLES
LOW LIFT OVAL TRACK Hydraulic Flat Tappet Camshaft											
862-16 ³⁷	3135 ⁵⁰ 3135KT	1431-16 ^{35,56} 1631-16 ¹	7472-16 7965-16	972-16 986-16 ²	740-16 730-16	611-16	502-16 503-16 ²	621-16	N/A	35200 35100	4013 ¹

⁵⁶ If equipped with studs and guide plates, use Part #1442-16

⁹³ GK-Kit contains cam, lifters & gear drive

FORD 351W 8 CYL. 1969-1996 (CONTINUED)

APPLICATIONS/CAMSHAFTS	VALVE SETTING		RPM OPERATING RANGE	CAM PART #	CAM GRIND #	DURATION				VALVE LIFT		LOBE SEP. ANGLE
	IN.	EX.				IN.	EX.	IN.	EX.	IN.	EX.	
XTREME ENERGY™ Retro-Fit Hydraulic Roller Camshafts (NOT FOR EFI)												
For Engines That DID NOT Come From The Factory With Hydraulic Roller Cams												
HYDRAULIC ROLLER – Mild performance applications, good low end and mid-range, good idle.	Hyd.	Hyd.	1200 to 5200	35-413-8	XR264RF-HR	264	270	212	218	.513	.513	110°
HYDRAULIC ROLLER – Good mid-range performance, 3.23+ gears, stock converter or 1800+ stall. Noticeable idle.	Hyd.	Hyd.	1500 to 5500	35-421-8	XR270RF-HR	270	276	218	224	.513	.513	110°
HYDRAULIC ROLLER – Strong mid-range performance, street machines with 3.55+ gears, 2200+ converter.	Hyd.	Hyd.	1800 to 5800	35-424-8	XR276RF-HR	276	282	224	230	.513	.513	110°
HYDRAULIC ROLLER – Great for street machines, needs intake, headers, 2500+ converter and 3.73+ gears, rough idle.	Hyd.	Hyd.	2000 to 6000	35-425-8	XR282RF-HR	282	289	230	236	.513	.529	110°
HYDRAULIC ROLLER – Street/strip, 9:1+ compression, intake, headers, 2800+ converter and 3.73+ gears, rough idle.	Hyd.	Hyd.	2200 to 6200	35-426-8	XR288RF-HR	288	294	236	240	.555	.576	110°
HYDRAULIC ROLLER – Street/strip, 9.5:1 compression, intake, headers, 3000+ converter, 4.10+ gears, rough idle.	Hyd.	Hyd.	2500 to 6500	35-427-8	XR294RF-HR	294	300	242	248	.576	.600	110°
MAGNUM Retro-Fit Hydraulic Roller Camshafts (NOT FOR EFI)												
For Engines That DID NOT Come From The Factory With Hydraulic Roller Cams												
HYDRAULIC ROLLER – Best with stock engine for economy or towing. Use with stock gears and converter, smooth idle.	Hyd.	Hyd.	1200 to 4500	35-412-8	260HR	260	260	206	206	.480	.480	110°
HYDRAULIC ROLLER – Mild street performance increase. Slight lobe at idle. Works with stock converter, best with 1800+ stall and gears.	Hyd.	Hyd.	1800 to 5000	35-422-8	270HR	270	270	215	215	.533	.533	110°
HYDRAULIC ROLLER – Great for street machines. Best power above 3500 RPM with good torque. Mild rough idle. Largest for stock heads and intake.	Hyd.	Hyd.	2000 to 5500	35-442-8	284HR	284	284	224	224	.533	.533	110°
HYDRAULIC ROLLER – Street machine and limited high performance street use. Best with 4 speed or 2800+ stall and 3.40 to 4.10 gears, aftermarket intake and headers.	Hyd.	Hyd.	2500 to 6000	35-452-8	290HR	290	290	230	230	.544	.544	110°
HYDRAULIC ROLLER – Street/strip, 4 speed or 3200+ stall and 4.10 or lower gear. Higher compression, good intake and headers.	Hyd.	Hyd.	3000 to 6500	35-462-8	304HR	304	304	244	244	.576	.576	110°

¹ Requires screw-in studs & guide plates
² Requires machining on cylinder heads

⁷ Stock springs cannot be used
³² Requires lifter installation kit Part #31-1000 for retro-fit applications

³⁵ Part #4504 studs required for 1978-present

FORD 351W 8 CYL. 1969-1996 (CONTINUED)

CAMSHAFTS FORD

K-KIT	SK-KIT	CL-KIT	LIFTERS	DIST. GEAR	TIMING SET	ROCKER ARMS	PUSHRODS	VALVE SPRINGS	RETAINERS	VALVE LOCKS	VALVE SEALS
XTREME ENERGY™ Retro-Fit Hydraulic Roller Camshafts (NOT FOR EFI)											
K35-413-8	SK35-413-8 ⁷	CL35-413-8 ⁷	851-16 ³² 8931-16	435M	2135 3135	1431-16 ^{35,56} 1631-16 ¹	7823-16 7963-16	986-16 ² 26986-16	740-16 795-16	611-16 614-16	503-16 ²
K35-421-8	SK35-421-8 ⁷	CL35-421-8 ⁷	851-16 ³² 8931-16	435M	2135 3135	1431-16 ^{35,56} 1631-16 ¹	7823-16 7963-16	986-16 ² 26986-16	740-16 795-16	611-16 614-16	503-16 ²
K35-424-8	SK35-424-8 ⁷	CL35-424-8 ⁷	851-16 ³² 8931-16	435M	2135 3135	1431-16 ^{35,56} 1631-16 ¹	7823-16 7963-16	986-16 ² 26986-16	740-16 795-16	611-16 614-16	503-16 ²
K35-425-8	SK35-425-8 ⁷	CL35-425-8 ⁷	851-16 ³² 8931-16	435M	2135 3135	1431-16 ^{35,56} 1631-16 ¹	7823-16 7963-16	986-16 ² 26986-16	740-16 795-16	611-16 614-16	503-16 ²
K35-426-8	SK35-426-8 ⁷	CL35-426-8 ⁷	851-16 ³² 8931-16	435M	2135 3135	1431-16 ^{35,56} 1631-16 ¹	7823-16 7963-16	987-16 ² 26986-16	740-16 795-16	611-16 614-16	503-16 ²
K35-427-8	SK35-427-8 ⁷	CL35-427-8 ⁷	851-16 ³² 8931-16	435M	2135 3135	1431-16 ^{35,56} 1631-16 ¹	7823-16 7963-16	987-16 ² 26986-16	740-16 795-16	611-16 614-16	503-16 ²
MAGNUM Retro-Fit Hydraulic Roller Camshafts (NOT FOR EFI)											
K35-412-8	SK35-412-8 ⁷	CL35-412-8 ⁷	851-16 ³² 8931-16	435M	2135 3135	1431-16 ^{35,56} 1631-16 ¹	7823-16 7963-16	986-16 ² 26986-16	740-16 795-16	611-16 614-16	503-16 ²
K35-422-8	SK35-422-8 ⁷	CL35-422-8 ⁷	851-16 ³² 8931-16	435M	2135 3135	1431-16 ^{35,56} 1631-16 ¹	7823-16 7963-16	986-16 ² 26986-16	740-16 795-16	611-16 614-16	503-16 ²
K35-442-8	SK35-442-8 ⁷	CL35-442-8 ⁷	851-16 ³² 8931-16	435M	2135 3135	1431-16 ^{35,56} 1631-16 ¹	7823-16 7963-16	986-16 ² 26986-16	740-16 795-16	611-16 614-16	503-16 ²
K35-452-8	SK35-452-8 ⁷	CL35-452-8 ⁷	851-16 ³² 8931-16	435M	2135 3135	1431-16 ^{35,56} 1631-16 ¹	7823-16 7963-16	986-16 ² 26986-16	740-16 795-16	611-16 614-16	503-16 ²
K35-462-8	SK35-462-8 ⁷	CL35-462-8 ⁷	851-16 ³² 8931-16	435M	2135 3135	1431-16 ^{35,56} 1631-16 ¹	7823-16 7963-16	987-16 ² 26986-16	740-16 795-16	611-16 614-16	503-16 ²

⁵⁰ Camshaft retaining plate Part #3120TB recommended

⁵⁶ If equipped with studs and guide plates, use Part #1442-16

RED NUMBERS DENOTE PREMIUM OPTION

FORD 351W 8 CYL. 1969-1996 (CONTINUED)

APPLICATIONS/CAMSHAFTS	VALVE SETTING		RPM OPERATING RANGE	CAM PART #	CAM GRIND #	DURATION				VALVE LIFT		LOBE SEP. ANGLE
	IN.	EX.				ADVERTISED IN.	EX.	@ .050" IN.	EX.	W/ 1.6 ROCKER IN.	EX.	
THUMPR™ Retro-Fit Hydraulic Roller Camshafts (Not For EFI)												
HYDRAULIC ROLLER – Thumpr™ – High performance street, stock converter ok, best with 2000+ converter and gears, choppy/thumping idle.	Hyd.	Hyd.	1900 to 5600	35-600-8⁹⁵	283THR7	283	303	227	241	.531	.515	107°
HYDRAULIC ROLLER – Mutha' Thumpr™ – High performance street/strip, needs 9:1 compression, 2500+ stall, intake, gears and headers, rough idle.	Hyd.	Hyd.	2200 to 5900	35-601-8⁹⁵	291THR7	291	311	235	249	.541	.526	107°
HYDRAULIC ROLLER – Big Mutha' Thumpr™ – Street/ strip, needs 9.5:1 compression, 2800+ stall, intake, gears and headers, very rough idle.	Hyd.	Hyd.	2500 to 6200	35-602-8⁹⁵	299THR7	299	319	243	257	.552	.538	107°

APPLICATIONS/CAMSHAFTS	VALVE SETTING		RPM OPERATING RANGE	CAM PART #	CAM GRIND #	DURATION				VALVE LIFT		LOBE SEP. ANGLE
	IN.	EX.				ADVERTISED IN.	EX.	@ .050" IN.	EX.	W/ 1.6 ROCKER IN.	EX.	
4-PATTERN Retro-Fit Hydraulic Roller Camshafts												

(Larger Cam Lobes For Outboard Cylinders)

HYDRAULIC ROLLER – Best choice for smaller c.i. applications with very good heads. Extremely wide power range. 1800+ stall.	Hyd.	Hyd.	1700 to 6300	35-561-44	269Q108	271 OB	283 OB	219 OB	229 OB	.603 OB	.590 OB	108.5 OB
						269 IB	281 IB	217 IB	227 IB	.600 IB	.587 IB	107.5 IB
HYDRAULIC ROLLER – Great all around choice for street applications in modified engines and 2500+ stall or manual transmissions.	Hyd.	Hyd.	2300 to 6600	35-562-44	281Q108	283 OB	295 OB	231 OB	241 OB	.622 OB	.610 OB	108.5 OB
						281 IB	293 IB	229 IB	239 IB	.619 IB	.606 IB	107.5 IB
HYDRAULIC ROLLER – Excellent for street/strip applications w/ good heads & raised compression in high RPM engines. 3200+ stall.	Hyd.	Hyd.	2900 to 7200	35-563-44	293Q108	295 OB	307 OB	243 OB	253 OB	.638 OB	.622 OB	108.5 OB
						293 IB	305 IB	241 IB	251 IB	.637 IB	.622 IB	107.5 IB
HYDRAULIC ROLLER – Recommended in larger c.i. & high compression applications. 3500+ stall.	Hyd.	Hyd.	3300 to 7500	35-564-44	305Q108	307 OB	319 OB	255 OB	265 OB	.638 OB	.622 OB	108.5 OB
						305 IB	317 IB	253 IB	263 IB	.638 IB	.622 IB	107.5 IB

LOW LIFT OVAL TRACK Mechanical Flat Tappet Camshaft

SOLID – 500" lift rule. Under 10" of vacuum with rough idle. Very good power.	.020	.022	3000 to 6500	35-637-5	270LS-6	270	282	242	250	.504	.504	106°
--	------	------	--------------	-----------------	---------	-----	-----	-----	-----	------	------	------

OVAL TRACK Mechanical Flat Tappet Camshafts

SOLID – Works well in restricted engines with stock manifolds, 2 BBL carb.	.020	.022	2500 to 6500	35-620-5	FL268S-6	268	276	238	246	.568	.584	106°
SOLID – Good in Late Model Stock on 1/4-1/2 mile, limited intake.	.020	.022	2500 to 6500	35-622-5	FL272S-6	272	280	242	250	.576	.592	106°
SOLID – 3/8-1/2 mile asphalt tracks. Late Model Stock, good power and torque.	.020	.022	3000 to 7000	35-624-5	FL276S-6	276	280	246	250	.584	.592	106°
SOLID – Good in Late Model Stock when high RPM can be maintained in turns.	.020	.022	3500 to 7000	35-626-5	FL280S-6	280	284	250	254	.592	.608	106°
SOLID – Good in heavy car on short tracks. Works with stock manifolds.	.020	.022	3000 to 6500	35-639-5	280B-6	280	284	242	246	.541	.522	106°
SOLID – Best all around solid cam. Makes strong torque and good power.	.020	.022	3000 to 6500	35-609-5	285B-6	285	295	250	260	.568	.592	106°
SOLID – Good for 1/4-3/8 mile tracks with high engine speed, great top end.	.020	.022	3700 to 7000	35-640-5	290B-6	290	304	255	266	.576	.570	106°
SOLID – Good for 1/4-3/8 mile tracks with light car and large engine.	.020	.022	3700 to 7500	35-641-5	300B-6	300	314	265	276	.600	.593	106°

¹ Requires screw-in studs & guide plates
² Requires machining on cylinder heads

⁷ Stock springs cannot be used
³⁵ Part #4504 studs required for 1978-present

⁵⁰ Camshaft retaining plate Part #3120TB recommended

FORD 351W 8 CYL. 1969-1996 (CONTINUED)

CAMSHAFTS FORD

K-KIT	GK-KIT	CL-KIT	LIFTERS	TIMING SET	GEAR DRIVE	ROCKER ARMS	PUSHRODS	VALVE SPRINGS	RETAINERS	VALVE LOCKS	VALVE SEALS	
THUMPR™ Retro-Fit Hydraulic Roller Camshafts (Not For EFI)												
K35-600-8	GK35-600-8 ⁹³	CL35-600-8 ⁷	8931-16	2135 3135	4120	1431-16 ^{35,56} 1631-16 ¹	7643-16 7963-16	986-16 ² 26986-16	740-16 795-16	611-16 614-16	503-16 ²	
K35-601-8	GK35-601-8 ⁹³	CL35-601-8 ⁷	8931-16	2135 3135	4120	1431-16 ^{35,56} 1631-16 ¹	7643-16 7963-16	986-16 ² 26986-16	740-16 795-16	611-16 614-16	503-16 ²	
K35-602-8	GK35-602-8 ⁹³	CL35-602-8 ⁷	8931-16	2135 3135	4120	1431-16 ^{35,56} 1631-16 ¹	7643-16 7963-16	986-16 ² 26986-16	740-16 795-16	611-16 614-16	503-16 ²	

LIFTERS	TIMING SET	ROCKER ARMS	PUSHRODS	VALVE SPRINGS	RETAINERS	VALVE LOCKS	VALVE SEALS	LASH CAPS	REV KIT	DIST. GEAR	STUD GIRDLES
4-PATTERN Retro-Fit Hydraulic Roller Camshafts											
15931-16	7138 8138	1631-16 1831-16	7643-16 7963-16	26926-16	1777-16	648-16	518-16	622-16	N/A	435M	4013
15931-16	7138 8138	1631-16 1831-16	7643-16 7963-16	26926-16	1777-16	648-16	518-16	622-16	N/A	435M	4013
15931-16	7138 8138	1631-16 1831-16	7643-16 7963-16	26926-16	1777-16	648-16	518-16	622-16	N/A	435M	4013
15931-16	7138 8138	1631-16 1831-16	7643-16 7963-16	26926-16	1777-16	648-16	518-16	622-16	N/A	435M	4013

LOW LIFT OVAL TRACK Mechanical Flat Tappet Camshaft											
833-16 817-16	3135 3135KT	1431-16 1631-16	7472-16 7965-16	972-16 986-16	740-16 1730-16	611-16	501-16 ² 503-16 ²	621-16	N/A	35200 35100	4013 ¹

OVAL TRACK Mechanical Flat Tappet Camshafts											
833-16 817-16	3135 ⁵⁰ 3135KT	1631-16 ¹ 1831-16 ¹	7965-16	929-16 ² 26094-16 ²	730-16 732-16	611-16	503-16 ²	621-16	N/A	35200 35100	4013 ¹
833-16 817-16	3135 ⁵⁰ 3135KT	1631-16 ¹ 1831-16 ¹	7965-16	929-16 ² 26094-16 ²	730-16 732-16	611-16	503-16 ²	621-16	N/A	35200 35100	4013 ¹
833-16 817-16	3135 ⁵⁰ 3135KT	1631-16 ¹ 1831-16 ¹	7965-16	929-16 ² 26094-16 ²	730-16 732-16	611-16	503-16 ²	621-16	N/A	35200 35100	4013 ¹
833-16 817-16	3135 ⁵⁰ 3135KT	1631-16 ¹ 1831-16 ¹	7965-16	929-16 ² 26094-16 ²	730-16 732-16	611-16	503-16 ²	621-16	N/A	35200 35100	4013 ¹
833-16 817-16	3135 ⁵⁰ 3135KT	1631-16 ¹ 1831-16 ¹	7965-16	929-16 ² 26094-16 ²	730-16 732-16	611-16	503-16 ²	621-16	N/A	35200 35100	4013 ¹
833-16 817-16	3135 ⁵⁰ 3135KT	1631-16 ¹ 1831-16 ¹	7965-16	929-16 ² 26094-16 ²	730-16 732-16	611-16	503-16 ²	621-16	N/A	35200 35100	4013 ¹
833-16 817-16	3135 ⁵⁰ 3135KT	1631-16 ¹ 1831-16 ¹	7965-16	929-16 ² 26094-16 ²	730-16 732-16	611-16	503-16 ²	621-16	N/A	35200 35100	4013 ¹

⁵⁶ If equipped with studs and guide plates, use Part #1442-16

⁹³ GK-Kit contains cam, lifters & gear drive
⁹⁵ Must use #8931-16 lifters with this cam

RED NUMBERS DENOTE PREMIUM OPTION

FORD 351W 8 CYL. 1969-1996 (CONTINUED)

APPLICATIONS/CAMSHAFTS	VALVE SETTING		RPM OPERATING RANGE	CAM PART #	CAM GRIND #	DURATION				VALVE LIFT		LOBE SEP. ANGLE
	IN.	EX.				ADVERTISED IN.	EX.	@ .050" IN.	EX.	W/ 1.6 ROCKER IN.	EX.	
XTREME ENERGY™ Mechanical Street Roller Camshafts												
MECHANICAL ROLLER – Good for weekend cruiser with 9:1 compression, 2000+ stall and lower gears. Noticeable idle.	.016	.018	2000 to 6000	35-769-8	XR268R	268	274	230	236	.589	.602	110°
MECHANICAL ROLLER – Great for power touring. Needs 2500+ stall, easy on parts. Very reliable power. Rough idle.	.016	.018	2200 to 6200	35-770-8	XR274R	274	280	236	242	.602	.608	110°
MECHANICAL ROLLER – Best in street machines w/ 2800+ stall, 10:1+ compression w/ 3.73-3.90 rear gears.	.016	.018	2500 to 6500	35-771-8	XR280R	280	286	242	248	.608	.614	110°
MECHANICAL ROLLER – Good in weekend warrior with 3000+ stall. Needs aftermarket intake and exhaust with low gears.	.016	.018	3000 to 7000	35-772-8	XR286R	286	292	248	254	.614	.621	110°
MECHANICAL ROLLER – Best for Pro Street. Needs aftermarket intake and exhaust, 11:1+ compression and 3500 stall.	.016	.018	3200 to 7200	35-773-8	XR292R	292	298	254	260	.621	.627	110°

APPLICATIONS/CAMSHAFTS	VALVE SETTING		RPM OPERATING RANGE	CAM PART #	CAM GRIND #	DURATION				VALVE LIFT		LOBE SEP. ANGLE
	IN.	EX.				ADVERTISED IN.	EX.	@ .050" IN.	EX.	W/ 1.6 ROCKER IN.	EX.	
DRAG RACE Mechanical Roller Camshafts												
MECHANICAL ROLLER – 351-377c.i. motor, 12:1+ compression, 4500+ stall.	.020	.022	4200 to 7200	35-780-9⁵	298DR-6	298	312	268	275	.696	.672	106°
MECHANICAL ROLLER – 351- 377c.i. Windsor with 125-250 HP nitrous.	.020	.022	4800 to 7500	35-781-9⁵	308DR-10	308	326	278	286	.696	.683	110°
MECHANICAL ROLLER – 377c.i.+ stroker with aftermarket race heads, 300+ nitrous, needs best parts throughout.	.020	.022	5500 to 8000	35-782-9⁵	318DR-12	318	336	282	300	.744	.731	112°

OVAL TRACK Mechanical Roller Camshafts												
MECHANICAL ROLLER – Good on 3/8-1/2 mile asphalt track with tight corners.	.020	.022	5800 to 7800	35-801-9⁵	292BR-6	292	296	256	260	.672	.672	106°
MECHANICAL ROLLER – For heavy cars with small c.i. Best for short tracks.	.020	.022	3200 to 6200	35-830-9⁵	288AR-6	288	296	252	258	.672	.672	106°
MECHANICAL ROLLER – More aggressive intake lobe, more torque. Good for sprint car.	.020	.022	3800 to 7000	35-831-9⁵	288BR-6	288	300	260	264	.704	.672	106°
MECHANICAL ROLLER – Best torque in 406+c.i. Late Model or 355c.i. with 9:5.1+ compression.	.020	.022	4500 to 7500	35-832-9⁵	292BR-6	292	304	264	268	.704	.672	106°

OVAL TRACK Mechanical Roller Camshafts

Xtreme RX Rollers use COMP's RX intake and RZ exhaust profiles to provide the ultimate in high RPM power and durability. Designed for use with light valve train above 8200 RPM. (Custom Grinds Available)

MECHANICAL ROLLER – Short track cam for 358 type engine. Very stable with good valve train parts.	.018	.020	6000 to 8500	35-826-9⁵	296RXA-6	296	301	263	268	.691	.691	106°
MECHANICAL ROLLER – Great for large c.i. engines or high RPM 358 type engines.	.018	.020	6300 to 8800	35-827-9⁵	300RXA-8	300	307	267	274	.696	.697	108°

¹ Requires screw-in studs & guide plates
² Requires machining on cylinder heads

⁵ Requires distributor gear upgrade
⁶ Offset lifters available

⁷ Stock springs cannot be used

FORD 351W 8 CYL. 1969-1996 (CONTINUED)

CAMSHAFTS FORD

K-KIT	CL-KIT	BRONZE GEAR	LIFTERS	DIST. GEAR	TIMING SET	ROCKER ARMS	PUSHRODS	VALVE SPRINGS	RETAINERS	VALVE LOCKS	VALVE SEALS
XTREME ENERGY™ Mechanical Street Roller Camshafts											
K35-769-8	CL35-769-8 ⁷	N/A	838-16 ⁶	435M	2135 3135	1631-16 ¹ 1831-16 ¹	7472-16 7965-16	953-16 ² 954-16 ²	741-16 732-16	611-16	503-16 ²
K35-770-8	CL35-770-8 ⁷	N/A	838-16 ⁶	435M	2135 3135	1631-16 ¹ 1831-16 ¹	7472-16 7965-16	953-16 ² 954-16 ²	741-16 732-16	611-16	503-16 ²
K35-771-8	CL35-771-8 ⁷	N/A	838-16 ⁶	435M	2135 3135	1631-16 ¹ 1831-16 ¹	7472-16 7965-16	953-16 ² 954-16 ²	741-16 732-16	611-16	503-16 ²
K35-772-8	CL35-772-8 ⁷	N/A	838-16 ⁶	435M	2135 3135	1631-16 ¹ 1831-16 ¹	7472-16 7965-16	953-16 ² 954-16 ²	741-16 732-16	611-16	503-16 ²
K35-773-8	CL35-773-8 ⁷	N/A	838-16 ⁶	435M	2135 3135	1631-16 ¹ 1831-16 ¹	7472-16 7965-16	953-16 ² 954-16 ²	741-16 732-16	611-16	503-16 ²
LIFTERS	TIMING SET	ROCKER ARMS	PUSHRODS	VALVE SPRINGS	RETAINERS	VALVE LOCKS	VALVE SEALS	LASH CAPS	REV KIT	DIST. GEAR	STUD GIRDLES
DRAG RACE Mechanical Roller Camshafts											
838-16 ⁶	3135KT ⁵⁰	1632-16 ^{1,59} 1832-16 ^{1,59}	7965-16	944-16 ²	731-16 720-16	611-16	503-16 ²	621-16	N/A	35200 35100	4014 ¹
838-16 ⁶	3135KT ⁵⁰	1632-16 ^{1,59} 1832-16 ^{1,59}	7965-16	944-16 ²	731-16 720-16	611-16	503-16 ²	621-16	N/A	35200 35100	4014 ¹
838-16 ⁶	3135KT ⁵⁰	1632-16 ^{1,59} 1832-16 ^{1,59}	7965-16	947-16 ²	739-16 722-16	611-16	506-16 ²	621-16	N/A	35200 35100	4014 ¹
OVAL TRACK Mechanical Roller Camshafts											
838-16 ⁶	3135KT ⁵⁰	1632-16 ^{1,59} 1832-16 ^{1,59}	7965-16	943-16 ² 26089-16 ²	731-16 720-16	611-16	503-16 ²	621-16	N/A	35200 35100	4014 ¹
838-16 ⁶ 98838-16 ⁶	3135KT ⁵⁰	1632-16 ^{1,59} 1832-16 ^{1,59}	7965-16	943-16 ² 26089-16 ²	1731-16 720-16	611-16	503-16 ²	621-16	N/A	35200 35100	4014 ¹
838-16 ⁶ 98838-16 ⁶	3135KT ⁵⁰	1632-16 ^{1,59} 1832-16 ^{1,59}	7965-16	26089-16 ² 26099-16 ²	1731-16 733-16	611-16	503-16 ²	621-16	N/A	35200 35100	4014 ¹
838-16 ⁶ 98838-16 ⁶	3135KT ⁵⁰	1632-16 ^{1,59} 1832-16 ^{1,59}	7965-16	26089-16 ²	1731-16	611-16	503-16 ²	621-16	N/A	35200	4014 ¹
OVAL TRACK Mechanical Roller Camshafts											
838-16 ⁶	3135KT ⁵⁰	1632-16 ^{1,59} 1832-16 ^{1,59}	7965-16	26089-16 ² 26099-16 ²	731-16 733-16	611-16	503-16 ²	621-16	N/A	35200 35100	4014 ¹
838-16 ⁶	3135KT ⁵⁰	1632-16 ^{1,59} 1832-16 ^{1,59}	7965-16	26089-16 ² 26099-16 ²	731-16 733-16	611-16	503-16 ²	621-16	N/A	35200 35100	4014 ¹

⁵⁰ Camshaft retaining plate Part #3120TB recommended

⁵⁹ Requires 7/16" rocker arm studs

RED NUMBERS DENOTE PREMIUM OPTION

FORD 351W 8 CYL. 1969-1996 (CONTINUED)

APPLICATIONS/CAMSHAFTS	VALVE SETTING		RPM OPERATING RANGE	CAM PART #	CAM GRIND #	DURATION				VALVE LIFT		LOBE SEP. ANGLE
	IN. EX.					ADVERTISED		@ .050"		W/ 1.6 ROCKER		
	IN.	EX.				IN.	EX.	IN.	EX.	IN.	EX.	
OVAL TRACK Mechanical Roller Camshafts (With 2.165"/1.968" Roller Bearings)												
MECHANICAL ROLLER – Short track cam for 358 type engine. Very stable with good valve train parts.	.018	.020	6000 to 8500	35-828-9⁵	296RXB-6	296	301	263	268	.691	.691	106°
MECHANICAL ROLLER – For high RPM 358 engines and for large cubic inches with less RPM.	.018	.020	6300 to 8800	35-829-9⁵	300RXB-8	300	307	267	274	.691	.691	108°

FORD 351C, 351M-400M 8 CYL. 1970-1983

APPLICATIONS/CAMSHAFTS	VALVE SETTING		RPM OPERATING RANGE	CAM PART #	CAM GRIND #	DURATION				VALVE LIFT		LOBE SEP. ANGLE
	IN. EX.					ADVERTISED		@ .050"		W/ 1.73 ROCKER		
	IN.	EX.				IN.	EX.	IN.	EX.	IN.	EX.	
HIGH ENERGY™ Hydraulic Flat Tappet Camshafts												
HYDRAULIC – Excellent torque & mileage. Smooth idle.	Hyd.	Hyd.	800 to 4800	32-218-3	252H	252	252	206	206	.468	.468	110°
HYDRAULIC – Great mid-range torque for towing. Good power at low speeds. Smooth idle.	Hyd.	Hyd.	1200 to 5200	32-219-3	260H	260	260	212	212	.484	.484	110°
HYDRAULIC – Everyday performance driving with stock converter, noticeable idle.	Hyd.	Hyd.	1500 to 5500	32-221-3	268H	268	268	218	218	.494	.494	110°
MAGNUM Hydraulic Flat Tappet Camshafts												
HYDRAULIC – Great for mild street machines. 2000+ stall, 3.30-4.0 gear, headers. Mild rough idle.	Hyd.	Hyd.	1800 to 5800	32-224-4	270H	270	270	224	224	.519	.519	110°
HYDRAULIC – Good in street machine with 2500+ stall, headers, gears, 9:1-10:1 compression. Rough idle.	Hyd.	Hyd.	2000 to 6000	32-225-4	280H	280	280	230	230	.530	.530	110°
HYDRAULIC – Street/strip use with 3000+ stall, 10:1 compression, low gears. Racy idle.	Hyd.	Hyd.	2500 to 6500	32-234-4	292H	292	292	244	244	.560	.560	110°
HYDRAULIC – Bracket race/limited street use, 3500+ stall, 11:1 compression, radical idle.	Hyd.	Hyd.	3000 to 7000	32-235-4	305H	305	305	253	253	.585	.585	110°
XTREME ENERGY™ Hydraulic Flat Tappet Camshafts												
HYDRAULIC – Strong torque through low end and mid-range, good idle.	Hyd.	Hyd.	1200 to 5200	32-241-4	XE256H	256	268	212	218	.487	.493	110°
HYDRAULIC – Strong torque, excellent response. Good mid-range, stock converter, 3.23 gears.	Hyd.	Hyd.	1400 to 5600	32-242-4	XE262H	262	270	218	224	.513	.520	110°
HYDRAULIC – Very strong mid-range and throttle response, 2400+ stall, 3.73+ gears.	Hyd.	Hyd.	2000 to 6000	32-246-4	XE274H	274	286	230	236	.562	.565	110°
HYDRAULIC – Street/strip with 2800+ stall, 9.5:1 compression, headers and gears, rough idle.	Hyd.	Hyd.	2300 to 6500	32-250-4	XE284H	284	296	240	246	.584	.588	110°

¹ Requires screw-in studs & guide plates
² Requires machining on cylinder heads

⁵ Requires distributor gear upgrade
⁶ Offset lifters available

⁷ Stock springs cannot be used
⁸ Fits only certain years

FORD 351W 8 CYL. 1969-1996 (CONTINUED)

LIFTERS	TIMING SET	ROCKER ARMS	PUSHRODS	VALVE SPRINGS	RETAINERS	VALVE LOCKS	VALVE SEALS	LASH CAPS	REV KIT	DIST. GEAR	STUD GIRDLES
OVAL TRACK Mechanical Roller Camshafts (With 2.165"/1.968" Roller Bearings)											
838-16 ⁶	3135KT ⁵⁰	1632-16 ^{1,59} 1832-16 ^{1,59}	7965-16	26089-16 ² 26099-16 ²	731-16 733-16	611-16	503-16 ²	621-16	N/A	35200 35100	4014 ¹
838-16 ⁶	3135KT ⁵⁰	1632-16 ^{1,59} 1832-16 ^{1,59}	7965-16	26089-16 ² 26099-16 ²	731-16 733-16	611-16	503-16 ²	621-16	N/A	35200 35100	4014 ¹

FORD 351C, 351M-400M 8 CYL. 1970-1983

K-KIT	SK-KIT	CL-KIT	RP-KIT	LIFTERS	TIMING SET	ROCKER ARMS	PUSHRODS	VALVE SPRINGS	RETAINERS	VALVE LOCKS	VALVE SEALS
HIGH ENERGY™ Hydraulic Flat Tappet Camshafts											
K32-218-3	SK32-218-3 ⁷	CL32-218-3 ⁷	N/A	832-16	3221	1411-16 ¹	7832-16 ⁸	940-16	743-16	601-16	502-16
K32-219-3	SK32-219-3 ⁷	CL32-219-3 ⁷	N/A	832-16	3221	1411-16 ¹	7832-16 ⁸	940-16	743-16	601-16	502-16
K32-221-3	SK32-221-3 ⁷	CL32-221-3 ⁷	N/A	832-16	3221	1411-16 ¹	7832-16 ⁸	940-16	743-16	601-16	502-16
MAGNUM Hydraulic Flat Tappet Camshafts											
K32-224-4	SK32-224-4 ⁷	CL32-224-4 ⁷	N/A	832-16 862-16 ³⁷	2121 3121	1411-16 ¹ 1630-16 ¹	7502-16 ⁸ 7945-16	972-16 924-16 ²	747-16 741-16	611-16 ⁷¹	502-16 503-16 ²
K32-225-4	SK32-225-4 ⁷	CL32-225-4 ⁷	N/A	832-16 862-16 ³⁷	2121 3121	1411-16 ¹ 1630-16 ¹	7502-16 ⁸ 7945-16	972-16 924-16 ²	747-16 741-16	611-16 ⁷¹	502-16 503-16 ²
K32-234-4	SK32-234-4 ⁷	CL32-234-4 ⁷	N/A	832-16 862-16 ³⁷	2121 3121	1411-16 ¹ 1630-16 ¹	7502-16 ⁸ 7945-16	924-16 ² 26120-16 ²	741-16 795-16	611-16 ⁷¹ 614-16 ⁷¹	503-16 ²
K32-235-4	SK32-235-4 ⁷	CL32-235-4 ⁷	N/A	832-16 862-16 ³⁷	2121 3121	1411-16 ¹ 1630-16 ¹	7502-16 ⁸ 7945-16	924-16 ² 26120-16 ²	741-16 795-16	611-16 ⁷¹ 614-16 ⁷¹	503-16 ²
XTREME ENERGY™ Hydraulic Flat Tappet Camshafts											
K32-241-4	SK32-241-4 ⁷	CL32-241-4 ⁷	N/A	832-16 862-16 ³⁷	2121 3121	1411-16 ¹ 1630-16 ¹	7502-16 ⁸ 7945-16	972-16 924-16 ²	747-16 741-16	611-16 ⁷¹	502-16 503-16 ²
K32-242-4	SK32-242-4 ⁷	CL32-242-4 ⁷	N/A	832-16 862-16 ³⁷	2121 3121	1411-16 ¹ 1630-16 ¹	7502-16 ⁸ 7945-16	972-16 924-16 ²	747-16 741-16	611-16 ⁷¹	502-16 503-16 ²
K32-246-4	SK32-246-4 ⁷	CL32-246-4 ⁷	N/A	832-16 862-16 ³⁷	2121 3121	1411-16 ¹ 1630-16 ¹	7502-16 ⁸ 7945-16	924-16 ² 26120-16 ²	741-16 795-16	611-16 ⁷¹ 614-16 ⁷¹	503-16 ²
K32-250-4	SK32-250-4 ⁷	CL32-250-4 ⁷	N/A	832-16 862-16 ³⁷	2121 3121	1411-16 ¹ 1630-16 ¹	7502-16 ⁸ 7945-16	924-16 ² 26120-16 ²	741-16 795-16	611-16 ⁷¹ 614-16 ⁷¹	503-16 ²

CAMSHAFTS FORD

³⁷ Adjustable valve train required

⁵⁰ Camshaft retaining plate Part #3120TB recommended

⁵⁹ Requires 7/16" rocker arm studs

⁷¹ For engines with multi-groove valves, use Part #624-16 locks. CAN NOT be used with lash caps.

RED NUMBERS DENOTE PREMIUM OPTION

FORD 351C, 351M-400M 8 CYL. 1970-1983 (CONTINUED)

APPLICATIONS/CAMSHAFTS	VALVE SETTING		RPM OPERATING RANGE	CAM PART #	CAM GRIND #	DURATION				VALVE LIFT		LOBE SEP. ANGLE
	IN.	EX.				ADVERTISED IN.	EX.	@ .050" IN.	EX.	W/ 1.73 ROCKER IN.	EX.	
THUMPR™ Hydraulic Flat Tappet Camshafts												
HYDRAULIC – Thumpr™-High performance street, stock converter ok, best with 2000+ converter and gears. Choppy/thumping idle.	Hyd.	Hyd.	2000 to 5800	32-600-5	279TH7	278	296	226	241	.506	.493	107°
HYDRAULIC – Mutha' Thumpr™-High performance street/strip, needs 9:1 compression, 2500+ stall, intake, gears and headers, rough idle.	Hyd.	Hyd.	2200 to 6100	32-601-5	287TH7	286	304	234	249	.519	.503	107°
HYDRAULIC – Big Mutha' Thumpr™-Street/strip, needs 9.5:1 compression, 2800+ stall, intake, gears and headers, very rough idle.	Hyd.	Hyd.	2500 to 6400	32-602-5	295TH7	294	312	242	257	.531	.515	107°

DUAL ENERGY™ Hydraulic Flat Tappet Camshafts												
HYDRAULIC – Good torque and mileage. Good RV and towing cam. Works well with stock exhaust.	Hyd.	Hyd.	1000 to 5500	32-206-3	255DEH	255	265	203	216	.465	.495	110°
HYDRAULIC – Very strong mid-range and torque. Everyday performance with stock exhaust.	Hyd.	Hyd.	1500 to 5750	32-207-3 32-207-20⁹⁴	265DEH	265	275	211	223	.484	.510	110°
HYDRAULIC – High performance street cam. Superior high end power. Works w/ 2000+ converter. Choppy idle.	Hyd.	Hyd.	2000 to 6000	32-208-3	275DEH	275	285	219	232	.515	.541	110°

DRAG RACE Hydraulic Flat Tappet Camshaft												
HYDRAULIC – Good torque in heavy car. 3500+ stall or 4 speed, 10:1 compression.	Hyd.	Hyd.	3000 to 7000	32-235-4	305H	305	305	253	253	.585	.585	110°

MAGNUM Retro-Fit Hydraulic Roller Camshafts												
Designed To Put Hydraulic Roller Cams & Lifters In All 351C Engines												
HYDRAULIC ROLLER – Best with stock engine for economy or towing. Can be used with stock gears and converter. Smooth idle.	Hyd.	Hyd.	1200 to 4500	32-411-8	260HR	260	260	205	205	.510	.510	110°
HYDRAULIC ROLLER – Mild street performance. Slightly noticeable lobe at idle. Will work w/ stock converter or even better w/ 1800+ stall & gear upgrade.	Hyd.	Hyd.	1800 to 5000	32-421-8	270HR	270	270	215	215	.566	.566	110°
HYDRAULIC ROLLER – Great in street machines. Best above 3500+ RPM. Good torque. Largest cam with stock heads and intake. Needs 2000+ stall.	Hyd.	Hyd.	2000 to 5500	32-431-8	284HR	284	284	224	224	.566	.566	110°
HYDRAULIC ROLLER – Perfect for street machine. Best with 4 speed and 3.40-4.10 gears. Aftermarket intake, headers and 2500+ stall.	Hyd.	Hyd.	2500 to 6000	32-541-8	290HR	290	290	230	230	.578	.578	110°
HYDRAULIC ROLLER – Street/strip only. 4 speed or 3000+ stall and 4.10 or lower gear. Higher compression, aftermarket intake and headers.	Hyd.	Hyd.	3000 to 6500	32-651-8	304HR	304	304	245	245	.612	.612	110°

¹ Requires screw-in studs & guide plates
² Requires machining on cylinder heads
⁷ Stock springs cannot be used

⁸ Fits only certain years
³² Requires lifter installation kit Part #31-1000 for retro-fit applications

³⁷ Adjustable valve train required
⁵⁵ For 351M and 400M engines, use Part #7824-16 pushrods on retro-fit cams

FORD 351C, 351M-400M 8 CYL. 1970-1983 (CONTINUED)

K-KIT	SK-KIT	CL-KIT	RP-KIT	LIFTERS	TIMING SET	ROCKER ARMS	PUSHRODS	VALVE SPRINGS	RETAINERS	VALVE LOCKS	VALVE SEALS
THUMPR™ Hydraulic Flat Tappet Camshafts											
K32-600-5	N/A	CL32-600-5 ⁷	N/A	832-16 862-16 ³⁷	2121 3121	1411-16 ¹ 1630-16 ¹	7502-16 ⁸ 7945-16	972-16 924-16 ²	747-16 741-16	611-16 ⁷¹	502-16 503-16 ²
K32-601-5	N/A	CL32-601-5 ⁷	N/A	832-16 862-16 ³⁷	2121 3121	1411-16 ¹ 1630-16 ¹	7502-16 ⁸ 7945-16	972-16 924-16 ²	747-16 741-16	611-16 ⁷¹	502-16 503-16 ²
K32-602-5	N/A	CL32-602-5 ⁷	N/A	832-16 862-16 ³⁷	2121 3121	1411-16 ¹ 1630-16 ¹	7502-16 ⁸ 7945-16	924-16 ² 26120-16 ²	741-16 795-16	611-16 ⁷¹ 614-16 ⁷¹	503-16 ²
DUAL ENERGY™ Hydraulic Flat Tappet Camshafts											
K32-206-3	SK32-206-3 ⁷	CL32-206-3 ⁷	N/A	832-16	3221	1411-16 ¹	7832-16 ⁸	940-16 924-16 ²	743-16 741-16	601-16	502-16 503-16 ²
K32-207-3	SK32-207-3 ⁷	CL32-207-3 ⁷	N/A	832-16	3221	1411-16 ¹	7832-16 ⁸	972-16 924-16 ²	747-16 741-16	611-16 ⁷¹	502-16 503-16 ²
K32-208-3	SK32-208-3 ⁷	CL32-208-3 ⁷	N/A	832-16	3221	1411-16 ¹	7832-16 ⁸	972-16 924-16 ²	747-16 741-16	611-16 ⁷¹	502-16 503-16 ²
LIFTERS	TIMING SET	ROCKER ARMS	PUSHRODS	VALVE SPRINGS	RETAINERS	VALVE LOCKS	VALVE SEALS	LASH CAPS	REV KIT	DIST. GEAR	STUD GIRDLES
DRAG RACE Hydraulic Flat Tappet Camshaft											
862-16 ³⁷	3121	1630-16 ¹ 1830-16 ¹	7945-16	928-16 ² 930-16 ²	741-16 732-16	611-16 ⁷¹	503-16 ²	621-16	N/A	432	4016 ⁷⁴
K-KIT	SK-KIT	CL-KIT	RP-KIT	LIFTERS	TIMING SET	ROCKER ARMS	PUSHRODS	VALVE SPRINGS	RETAINERS	VALVE LOCKS	VALVE SEALS
MAGNUM Retro-Fit Hydraulic Roller Camshafts											
K32-411-8	SK32-411-8 ⁷	CL32-411-8 ⁷	N/A	851-16 ³² 8931-16	2121 3121	1411-16 ¹ 1630-16 ¹	7825-16 ⁵⁵ 7974-16	924-16 ² 26120-16 ²	741-16 795-16	611-16 ⁷¹ 614-16 ⁷¹	503-16 ²
K32-421-8	SK32-421-8 ⁷	CL32-421-8 ⁷	N/A	851-16 ³² 8931-16	2121 3121	1411-16 ¹ 1630-16 ¹	7825-16 ⁵⁵ 7974-16	924-16 ² 26120-16 ²	741-16 795-16	611-16 ⁷¹ 614-16 ⁷¹	503-16 ²
K32-431-8	SK32-431-8 ⁷	CL32-431-8 ⁷	N/A	851-16 ³² 8931-16	2121 3121	1411-16 ¹ 1630-16 ¹	7825-16 ⁵⁵ 7974-16	924-16 ² 26120-16 ²	741-16 795-16	611-16 ⁷¹ 614-16 ⁷¹	503-16 ²
K32-541-8	SK32-541-8 ⁷	CL32-541-8 ⁷	N/A	851-16 ³² 8931-16	2121 3121	1411-16 ¹ 1630-16 ¹	7825-16 ⁵⁵ 7974-16	924-16 ² 26120-16 ²	741-16 795-16	611-16 ⁷¹ 614-16 ⁷¹	503-16 ²
K32-651-8	SK32-651-8 ⁷	CL32-651-8 ⁷	N/A	851-16 ³² 8931-16	2121 3121	1411-16 ¹ 1630-16 ¹	7825-16 ⁵⁵ 7974-16	924-16 ² 930-16 ²	741-16 732-16	611-16 ⁷¹	503-16 ²

⁷¹ For engines with multi-groove valves, use Part #624-16 locks. CAN NOT be used with lash caps.

⁷⁴ Fits only 302/351C Boss & SVO heads
⁹⁴ Nitrided version

FORD 351C, 351M-400M 8 CYL. 1970-1983 (CONTINUED)

APPLICATIONS/CAMSHAFTS	VALVE SETTING		RPM OPERATING RANGE	CAM PART #	CAM GRIND #	DURATION				VALVE LIFT		LOBE SEP. ANGLE
	IN.	EX.				ADVERTISED IN.	EX.	@ .050" IN.	EX.	W/ 1.73 ROCKER IN.	EX.	
THUMPR™ Retro-Fit Hydraulic Roller Camshafts												
HYDRAULIC ROLLER – Thumpr™ – High performance street, stock converter ok, best with 2000+ converter and gears, choppy/thumping idle.	Hyd.	Hyd.	1900 to 5600	32-600-8	283THR7	283	303	227	241	.557	.539	107°
HYDRAULIC ROLLER – Mutha' Thumpr™ – High performance street/strip, needs 9:1 compression, 2500+ stall, intake, gears and headers, rough idle.	Hyd.	Hyd.	2200 to 5900	32-601-8	291THR7	291	311	235	249	.567	.551	107°
HYDRAULIC ROLLER – Big Mutha' Thumpr™ – Street/strip, needs 9.5:1 compression, 2800+ stall, intake, gears and headers, very rough idle.	Hyd.	Hyd.	2500 to 6200	32-602-8	299THR7	299	319	243	257	.579	.563	107°
MAGNUM Mechanical Flat Tappet Camshafts												
SOLID – Excellent torque. Everyday performance. 2000+ converter and 9:1 compression. Noticeable idle.	.022	.022	1800 to 5800	32-237-4	270S	270	270	224	224	.540	.540	110°
SOLID – Street machine w/ headers, 2500+ converter, 9:1 compression. Great mid-range power. Mild rough idle.	.022	.022	2000 to 6000	32-238-4	282S	282	282	236	236	.570	.570	110°
SOLID – Street/strip, 3000+ stall, low gear, 10:1 compression. Rough idle. Great mid-range and top end.	.022	.022	2500 to 6500	32-239-4	294S	294	294	248	248	.605	.605	110°
SOLID – Pro Street/bracket race. Excellent top end, 3500+ stall and 11:1 compression. Radical idle.	.022	.022	3000 to 7000	32-240-4	306S	306	306	260	260	.640	.640	110°
DRAG RACE Mechanical Flat Tappet Camshafts												
SOLID – Best in large c.i. street machine. 10:1 compression, 3500+ stall, 4.10 gear.	.028	.030	3200 to 6200	32-638-5	284B-8	284	294	246	256	.564	.589	108°
SOLID – Excellent torque for heavy cars, 3500+ stall or 4 speed with 10.5:1 compression.	.028	.030	3800 to 6800	32-644-5	294B-6	294	304	256	266	.589	.615	106°
OVAL TRACK Mechanical Flat Tappet Camshaft												
SOLID – Best for 1/4-3/8 mile track, broad torque range.	.022	.024	3500 to 6500	32-642-5	285B-6	285	295	250	260	.614	.645	106°
MAGNUM Mechanical Roller Camshafts												
MECHANICAL ROLLER – Great power for serious street use. 3000+ stall w/ low gear & headers. Rough idle.	.020	.020	2500 to 6500	32-771-9⁵	288R	288	288	243	243	.636	.636	110°
MECHANICAL ROLLER – Ultimate Pro Street cam. 4000+ stall or 4 speed, 11:1 comp., radical race idle.	.020	.020	3000 to 7000	32-772-9⁵	308R	308	308	262	262	.662	.662	110°

¹ Requires screw-in studs & guide plates
² Requires machining on cylinder heads
⁵ Requires distributor gear upgrade

⁶ Offset lifters available
⁷ Stock springs cannot be used
⁸ Fits only certain years

³² Requires lifter installation kit Part #31-1000 for retro-fit applications

FORD 351C, 351M-400M 8 CYL. 1970-1983 (CONTINUED)

K-KIT	SK-KIT	CL-KIT	RP-KIT	LIFTERS	TIMING SET	ROCKER ARMS	PUSHRODS	VALVE SPRINGS	RETAINERS	VALVE LOCKS	VALVE SEALS
THUMPR™ Retro-Fit Hydraulic Roller Camshafts											
K32-600-8	N/A	CL32-600-8 ⁷	N/A	851-16 ³² 8931-16	2121 3121	1411-16 ¹ 1630-16 ¹	7825-16 ⁵⁵ 7974-16	924-16 ² 26120-16 ²	741-16 795-16	611-16 ⁷¹ 614-16 ⁷¹	503-16 ²
K32-601-8	N/A	CL32-601-8 ⁷	N/A	851-16 ³² 8931-16	2121 3121	1411-16 ¹ 1630-16 ¹	7825-16 ⁵⁵ 7974-16	924-16 ² 26120-16 ²	741-16 795-16	611-16 ⁷¹ 614-16 ⁷¹	503-16 ²
K32-602-8	N/A	CL32-602-8 ⁷	N/A	851-16 ³² 8931-16	2121 3121	1411-16 ¹ 1630-16 ¹	7825-16 ⁵⁵ 7974-16	924-16 ² 26120-16 ²	741-16 795-16	611-16 ⁷¹ 614-16 ⁷¹	503-16 ²
MAGNUM Mechanical Flat Tappet Camshafts											
K32-237-4	SK32-237-4 ⁷	CL32-237-4 ⁷	N/A	833-16 817-16	2121 3121	1411-16 ¹ 1630-16 ¹	7502-16 ⁸ 7945-16 ⁸	924-16 924-16 ²	747-16 741-16	611-16 ⁷¹	502-16 503-16 ²
K32-238-4	SK32-238-4 ⁷	CL32-238-4 ⁷	N/A	833-16 817-16	2121 3121	1411-16 ¹ 1630-16 ¹	7502-16 ⁸ 7945-16 ⁸	924-16 924-16 ²	747-16 741-16	611-16 ⁷¹	502-16 503-16 ²
K32-239-4	SK32-239-4 ⁷	CL32-239-4 ⁷	N/A	833-16 817-16	2121 3121	1411-16 ¹ 1630-16 ¹	7502-16 ⁸ 7945-16 ⁸	924-16 ² 930-16 ²	741-16 732-16	611-16 ⁷¹	503-16 ²
K32-240-4	SK32-240-4 ⁷	CL32-240-4 ⁷	N/A	833-16 817-16	2121 3121	1411-16 ¹ 1630-16 ¹	7502-16 ⁸ 7945-16 ⁸	924-16 ² 930-16 ²	741-16 732-16	611-16 ⁷¹	503-16 ²
LIFTERS	TIMING SET	ROCKER ARMS	PUSHRODS	VALVE SPRINGS	RETAINERS	VALVE LOCKS	VALVE SEALS	LASH CAPS	REV KIT	DIST. GEAR	STUD GIRDLES
DRAG RACE Mechanical Flat Tappet Camshafts											
833-16 817-16	3121	1630-16 ¹ 1830-16 ¹	7945-16 ⁸	924-16 ² 930-16 ²	741-16 732-16	611-16 ⁷¹	503-16 ²	621-16	N/A	432	4016 ⁷⁴
833-16 817-16	3121	1630-16 ¹ 1830-16 ¹	7945-16 ⁸	924-16 ² 930-16 ²	741-16 732-16	611-16 ⁷¹	503-16 ²	621-16	N/A	432	4016 ⁷⁴
OVAL TRACK Mechanical Flat Tappet Camshaft											
833-16 817-16	3121	1630-16 ¹ 1830-16 ¹	7945-16 ⁸	924-16 ² 930-16 ²	741-16 732-16	611-16 ⁷¹	503-16 ²	621-16	N/A	432	4016 ⁷⁴
K-KIT	SK-KIT	CL-KIT	LIFTERS	DIST. GEAR	TIMING SET	ROCKER ARMS	PUSHRODS	VALVE SPRINGS	RETAINERS	VALVE LOCKS	VALVE SEALS
MAGNUM Mechanical Roller Camshafts											
K32-771-9	SK32-771-9 ⁷	CL32-771-9 ⁷	840-16 ⁶	432	2121 3121	1630-16 ¹ 1830-16 ¹	7502-16 ⁸	929-16 ² 939-16 ²	749-16 741-16	611-16 ⁷¹	503-16 ²
K32-772-9	SK32-772-9 ⁷	CL32-772-9 ⁷	840-16 ⁶	432	2121 3121	1630-16 ¹ 1830-16 ¹	7502-16 ⁸	929-16 ² 939-16 ²	749-16 741-16	611-16 ⁷¹	503-16 ²

⁵⁵ For 351M and 400M engines, use Part #7824-16 pushrods on retro-fit cams

⁷¹ For engines with multi-groove valves, use Part #624-16 locks. CAN NOT be used w/ lash caps.

⁷⁴ Fits only 302/351C Boss & SVO heads



FORD 332, 352, 390, 406 C.I. 8 CYL. 1958-1962

APPLICATIONS/CAMSHAFTS	VALVE SETTING		RPM OPERATING RANGE	CAM PART #	CAM GRIND #	DURATION				VALVE LIFT		LOBE SEP. ANGLE
	IN.	EX.				IN.	EX.	IN.	EX.	IN.	EX.	
CLASSIC THUMPR™ Hydraulic Flat Tappet Camshafts												
HYDRAULIC – Classic Thumpr™ – Performance street, needs gears, choppy/thumping idle.	Hyd.	Hyd.	2000-5300	104-600-5	279TH7	278	297	226	241	.506	.493	107°
HYDRAULIC – Classic Mutha' Thumpr™ – High performance street/strip, needs higher compression, modified heads, gears and headers, rough idle.	Hyd.	Hyd.	2200-5500	104-601-5	287TH7	286	304	234	249	.519	.503	107°
HYDRAULIC – Classic Big Mutha' Thumpr™ – Street/strip, needs higher compression, aftermarket heads, gears and headers, very rough idle.	Hyd.	Hyd.	2500-5800	104-602-5	295TH7	294	312	242	257	.531	.515	107°

FORD 352-428 C.I. 8 CYL. 1963-1977

APPLICATIONS/CAMSHAFTS	VALVE SETTING		RPM OPERATING RANGE	CAM PART #	CAM GRIND #	DURATION				VALVE LIFT		LOBE SEP. ANGLE
	IN.	EX.				IN.	EX.	IN.	EX.	IN.	EX.	
HIGH ENERGY™ Hydraulic Flat Tappet Camshafts												
HYDRAULIC – Great low end torque and economy, smooth idle.	Hyd.	Hyd.	800 to 4800	33-221-3	252H	252	252	206	206	.468	.468	110°
HYDRAULIC – Great for vans, trucks and 4WD. Excellent for towing, mid-range torque. Smooth idle.	Hyd.	Hyd.	1200 to 5200	33-222-3	260H	260	260	212	212	.484	.484	110°
HYDRAULIC – Good upgrade for factory performance cams in 390-428. Noticeable idle.	Hyd.	Hyd.	1500 to 5500	33-224-3	268H	268	268	218	218	.494	.494	110°
MAGNUM Hydraulic Flat Tappet Camshafts												
HYDRAULIC – Good cam for stock and even better for 2000 stall converter in street machine, 9:1 compression, mild rough idle.	Hyd.	Hyd.	1800 to 5800	33-226-4	270H	270	270	224	224	.519	.519	110°
HYDRAULIC – Works best in street machines with 2000+ stall, lower gears and headers. Rough idle.	Hyd.	Hyd.	2000 to 6000	33-230-4	280H	280	280	230	230	.530	.530	110°
HYDRAULIC – Street/strip, use 9.5:1+ compression w/ headers, intake, low gears and 3000+ stall. Racy idle.	Hyd.	Hyd.	2500 to 6500	33-240-4	292H	292	292	244	244	.560	.560	110°
HYDRAULIC – Best cam for Pro Street or bracket racing. 3500+ stall, 10.5:1+ compression. Radical race idle.	Hyd.	Hyd.	3000 to 6800	33-241-4	305H	305	305	253	253	.585	.585	110°
XTREME ENERGY™ Hydraulic Flat Tappet Camshafts												
HYDRAULIC – Strong torque through low and mid-range. Good economy. Mild idle.	Hyd.	Hyd.	1000 to 5200	33-234-4	XE256H	256	268	212	218	.487	.493	110°
HYDRAULIC – Strong torque, excellent throttle response. Will work w/ stock converter but prefers 1800+ stall.	Hyd.	Hyd.	1300 to 5600	33-238-4	XE262H	262	270	218	224	.513	.520	110°
HYDRAULIC – High performance street, very strong mid-range with headers, 2400+ stall & lower gears.	Hyd.	Hyd.	1800 to 6000	33-248-4	XE274H	274	286	230	236	.562	.565	110°
HYDRAULIC – Street/strip 2800+ stall, headers, 9.5:1 compression, lower gears, rough idle.	Hyd.	Hyd.	2300 to 6500	33-250-4	XE284H	284	296	240	246	.584	.588	110°

² Requires machining on cylinder heads
⁷ Stock springs cannot be used

⁴⁰ Includes special shafts

⁶² Part #7833 only works w/ non-adjustable factory rocker arms, use Part #7533 for adjustable rockers

FORD 332, 352, 390, 406 C.I. 8 CYL. 1958-1962

K-KIT	SK-KIT	CL-KIT	LIFTERS	DIST. GEAR	TIMING SET	ROCKER ARMS	PUSHRODS	VALVE SPRINGS	RETAINERS	VALVE LOCKS	VALVE SEALS	
CLASSIC THUMPR™ Hydraulic Flat Tappet Camshafts												
N/A	N/A	N/A	834-16	N/A	N/A	N/A	N/A	N/A	N/A	N/A	N/A	
N/A	N/A	N/A	834-16	N/A	N/A	N/A	N/A	N/A	N/A	N/A	N/A	
N/A	N/A	N/A	834-16	N/A	N/A	N/A	N/A	N/A	N/A	N/A	N/A	

FORD 352-428 C.I. 8 CYL. 1963-1977

K-KIT	SK-KIT	CL-KIT	RP-KIT	LIFTERS	TIMING SET	ROCKER ARMS	PUSHRODS	VALVE SPRINGS	RETAINERS	VALVE LOCKS	VALVE SEALS	
HIGH ENERGY™ Hydraulic Flat Tappet Camshafts												
K33-221-3	SK33-221-3 ⁷	CL33-221-3 ⁷	N/A	834-16	3208	1046-KIT ⁴⁰	7833-16 ⁶²	940-16	744-16	603-16	504-16	
K33-222-3	SK33-222-3 ⁷	CL33-222-3 ⁷	N/A	834-16	3208	1046-KIT ⁴⁰	7833-16 ⁶²	940-16	744-16	603-16	504-16	
K33-224-3	SK33-224-3 ⁷	CL33-224-3 ⁷	N/A	834-16	3208	1046-KIT ⁴⁰	7833-16 ⁶²	940-16	744-16	603-16	504-16	
MAGNUM Hydraulic Flat Tappet Camshafts												
K33-226-4	SK33-226-4 ⁷	CL33-226-4 ⁷	N/A	834-16	2108 3108	1046-KIT ⁴⁰	7833-16 ⁶² 7530-16	926-16 924-16 ²	747-16 741-16	612-16	504-16 505-16 ²	
K33-230-4	SK33-230-4 ⁷	CL33-230-4 ⁷	N/A	834-16	2108 3108	1046-KIT ⁴⁰ 1046HD-KIT ⁶⁹	7833-16 ⁶² 7530-16	926-16 924-16 ²	747-16 741-16	612-16	504-16 505-16 ²	
K33-240-4	SK33-240-4 ⁷	CL33-240-4 ⁷	N/A	834-16	2108 3108	1046-KIT ⁴⁰ 1046HD-KIT ⁶⁹	7833-16 ⁶² 7530-16	924-16 ² 26120-16 ²	741-16 795-16	612-16 616-16	505-16 ²	
K33-241-4	SK33-241-4 ⁷	CL33-241-4 ⁷	N/A	834-16	2108 3108	1046-KIT ⁴⁰ 1046HD-KIT ⁶⁹	7833-16 ⁶² 7530-16	924-16 ² 26120-16 ²	741-16 795-16	612-16 616-16	505-16 ²	
XTREME ENERGY™ Hydraulic Flat Tappet Camshafts												
K33-234-4	SK33-234-4 ⁷	CL33-234-4 ⁷	N/A	834-16	2108 3108	1046-KIT ⁴⁰ 1046HD-KIT ⁶⁹	7833-16 ⁶² 7530-16	926-16 924-16 ²	747-16 741-16	612-16	504-16 505-16 ²	
K33-238-4	SK33-238-4 ⁷	CL33-238-4 ⁷	N/A	834-16	2108 3108	1046-KIT ⁴⁰ 1046HD-KIT ⁶⁹	7833-16 ⁶² 7530-16	926-16 924-16 ²	747-16 741-16	612-16	504-16 505-16 ²	
K33-248-4	SK33-248-4 ⁷	CL33-248-4 ⁷	N/A	834-16	2108 3108	1046-KIT ⁴⁰ 1046HD-KIT ⁶⁹	7833-16 ⁶² 7530-16	924-16 ² 26120-16 ²	741-16 795-16	612-16 616-16	505-16 ²	
K33-250-4	SK33-250-4 ⁷	CL33-250-4 ⁷	N/A	834-16	2108 3108	1046-KIT ⁴⁰ 1046HD-KIT ⁶⁹	7833-16 ⁶² 7530-16	924-16 ² 26120-16 ²	741-16 795-16	612-16 616-16	505-16 ²	

⁶⁹ Includes special rockers & shafts Part #1047-2

FORD 352-428 C.I. 8 CYL. 1963-1977 (CONTINUED)

APPLICATIONS/CAMSHAFTS	VALVE SETTING		RPM OPERATING RANGE	CAM PART #	CAM GRIND #	DURATION				VALVE LIFT		LOBE SEP. ANGLE
	IN.	EX.				ADVERTISED IN.	EX.	@ .050" IN.	EX.	W/ 1.73 ROCKER IN.	EX.	
THUMPR™ Hydraulic Flat Tappet Camshafts												
HYDRAULIC – Thumpr™ – High performance street, stock converter ok, best with 2000+ converter and gears. Choppy/thumping idle.	Hyd.	Hyd.	2000 to 5800	33-600-5	279TH7	278	296	226	241	.506	.493	107°
HYDRAULIC – Mutha' Thumpr™ – High performance street/strip, needs 9:1 compression, 2500+ stall, intake, gears and headers, rough idle.	Hyd.	Hyd.	2200 to 6100	33-601-5	287TH7	286	304	234	249	.519	.503	107°
HYDRAULIC – Big Mutha' Thumpr™ – Street/strip, needs 9.5:1 compression, 2800+ stall, intake, gears and headers, very rough idle.	Hyd.	Hyd.	2500 to 6400	33-602-5	295TH7	294	312	242	257	.531	.515	107°
DUAL ENERGY™ Hydraulic Flat Tappet Camshafts												
HYDRAULIC – Good torque and mileage. Good RV and towing camshaft. Works with stock exhaust.	Hyd.	Hyd.	1000 to 5500	33-206-3	255DEH	255	265	203	216	.469	.495	110°
HYDRAULIC – Very strong mid-range. Everyday performance with stock exhaust.	Hyd.	Hyd.	1500 to 5750	33-207-3	265DEH	265	275	211	223	.484	.510	110°
HYDRAULIC – High performance street. Superior high end power. Best w/ 1800+ converter. Choppy idle.	Hyd.	Hyd.	2000 to 6000	33-208-3	275DEH	275	285	219	232	.515	.541	110°
XTREME ENERGY™ Retro-Fit Hydraulic Roller Camshafts												
HYDRAULIC ROLLER – Great mid-range torque in performance street application, likes headers.	Hyd.	Hyd.	1800-5400	33-422-9	XR270HR	270	276	218	224	.521	.521	110°
HYDRAULIC ROLLER – High performance for street cars with 2200+ stall, 9:1+ compression, headers.	Hyd.	Hyd.	2200-5800	33-432-9	XR280HR	282	288	230	236	.521	.532	110°
HYDRAULIC ROLLER – Street/strip applications, 10:1 + compression, 3000+ stall, intake, headers, gear.	Hyd.	Hyd.	2800-6100	33-443-9	XR294HR	294	300	242	248	.553	.572	110°
THUMPR™ Retro-Fit Hydraulic Roller Camshafts												
HYDRAULIC ROLLER – Thumpr™ – High performance street, stock converter ok, best with 2000+ converter and gears, choppy/thumping idle.	Hyd.	Hyd.	1900 to 5600	33-600-9	283THR7	283	303	227	241	.557	.539	107°
HYDRAULIC ROLLER – Mutha' Thumpr™ – High performance street/strip, needs 9:1 compression, 2500+ stall, intake, gears and headers, rough idle.	Hyd.	Hyd.	2200 to 5900	33-601-9	291THR7	291	311	235	249	.567	.551	107°
HYDRAULIC ROLLER – Big Mutha' Thumpr™ – Street/strip, needs 9.5:1 compression, 2800+ stall, intake, gears and headers, very rough idle.	Hyd.	Hyd.	2500 to 6200	33-602-9	299THR7	299	319	243	257	.579	.563	107°
DRAG RACE Hydraulic Flat Tappet Camshafts												
HYDRAULIC – Good for automatic with 3500+ stall, 10:1 compression.	Hyd.	Hyd.	3500 to 6800	33-242-5	312H-10	312	312	260	260	.611	.611	110°

² Requires machining on cylinder heads
⁷ Stock springs cannot be used

⁴⁰ Includes special shafts
⁶² Part #7833 only works w/ non-adjustable factory rocker arms, use Part #7533 for adjustable rockers

⁶⁹ Includes special rockers & shafts Part #1047-2

FORD 352-428 C.I. 8 CYL. 1963-1977 (CONTINUED)

K-KIT	SK-KIT	CL-KIT	RP-KIT	LIFTERS	TIMING SET	ROCKER ARMS	PUSHRODS	VALVE SPRINGS	RETAINERS	VALVE LOCKS	VALVE SEALS
THUMPR™ Hydraulic Flat Tappet Camshafts											
K33-600-5	N/A	CL33-600-5 ⁷	N/A	834-16	2108 3108	1046-KIT ⁴⁰ 1046HD-KIT ⁶⁹	7833-16 ⁶² 7530-16	926-16 924-16 ²	747-16 741-16	612-16	504-16 505-16 ²
K33-601-5	N/A	CL33-601-5 ⁷	N/A	834-16	2108 3108	1046-KIT ⁴⁰ 1046HD-KIT ⁶⁹	7833-16 ⁶² 7530-16	926-16 924-16 ²	747-16 741-16	612-16	504-16 505-16 ²
K33-602-5	N/A	CL33-602-5 ⁷	N/A	834-16	2108 3108	1046-KIT ⁴⁰ 1046HD-KIT ⁶⁹	7833-16 ⁶² 7530-16	926-16 924-16 ²	747-16 741-16	612-16	504-16 505-16 ²
DUAL ENERGY™ Hydraulic Flat Tappet Camshafts											
K33-206-3	SK33-206-3 ⁷	CL33-206-3 ⁷	N/A	834-16	2108 3108	1046-KIT ⁴⁰ 1046HD-KIT ⁶⁹	7833-16 ⁶² 7530-16	940-16 926-16	744-16 747-16	603-16 612-16	504-16 505-16 ²
K33-207-3	SK33-207-3 ⁷	CL33-207-3 ⁷	N/A	834-16	2108 3108	1046-KIT ⁴⁰ 1046HD-KIT ⁶⁹	7833-16 ⁶² 7530-16	926-16 924-16 ²	747-16 741-16	612-16	504-16 505-16 ²
K33-208-3	SK33-208-3 ⁷	CL33-208-3 ⁷	N/A	834-16	2108 3108	1046-KIT ⁴⁰ 1046HD-KIT ⁶⁹	7833-16 ⁶² 7530-16	926-16 924-16 ²	747-16 741-16	612-16	504-16 505-16 ²
XTREME ENERGY™ Retro-Fit Hydraulic Roller Camshafts											
K33-422-9	N/A	CL33-422-9 ⁷	N/A	8934-16	2108 3108	1046-KIT ⁴⁰ 1046HD-KIT ⁶⁹	N/A	924-16 ² 26120-16 ²	741-16 795-16	612-16 616-16	505-16 ²
K33-432-9	N/A	CL33-432-9 ⁷	N/A	8934-16	2108 3108	1046-KIT ⁴⁰ 1046HD-KIT ⁶⁹	N/A	924-16 ² 26120-16 ²	741-16 795-16	612-16 616-16	505-16 ²
K33-443-9	N/A	CL33-443-9 ⁷	N/A	8934-16	2108 3108	1046-KIT ⁴⁰ 1046HD-KIT ⁶⁹	N/A	924-16 ² 26120-16 ²	741-16 795-16	612-16 616-16	505-16 ²
THUMPR™ Retro-Fit Hydraulic Roller Camshafts											
K33-600-9	N/A	CL33-600-9 ⁷	N/A	8934-16	2108 3108	1046-KIT ⁴⁰ 1046HD-KIT ⁶⁹	N/A	924-16 ² 26120-16 ²	741-16 795-16	612-16 616-16	505-16 ²
K33-601-9	N/A	CL33-601-9 ⁷	N/A	8934-16	2108 3108	1046-KIT ⁴⁰ 1046HD-KIT ⁶⁹	N/A	924-16 ² 26120-16 ²	741-16 795-16	612-16 616-16	505-16 ²
K33-602-9	N/A	CL33-602-9 ⁷	N/A	8934-16	2108 3108	1046-KIT ⁴⁰ 1046HD-KIT ⁶⁹	N/A	924-16 ² 26120-16 ²	741-16 795-16	612-16 616-16	505-16 ²
LIFTERS	TIMING SET	ROCKER ARMS	PUSHRODS	VALVE SPRINGS	RETAINERS	VALVE LOCKS	VALVE SEALS	LASH CAPS	REV KIT	DIST. GEAR	STUD GIRDLES
DRAG RACE Hydraulic Flat Tappet Camshafts											
834-16	3108 3108KT	1046-KIT ⁴⁰ 1046HD-KIT ⁶⁹	7530-16	930-16 ² 928-16 ²	749-16 732-16	612-16	505-16 ²	622-16	N/A	N/A	N/A

RED NUMBERS DENOTE PREMIUM OPTION

FORD 352-428 C.I. 8 CYL. 1963-1977 (CONTINUED)

APPLICATIONS/CAMSHAFTS	VALVE SETTING		RPM OPERATING RANGE	CAM PART #	CAM GRIND #	DURATION				VALVE LIFT		LOBE SEP. ANGLE
	IN.	EX.				ADVERTISED IN.	EX.	@ .050" IN.	EX.	W/ 1.73 ROCKER IN.	EX.	
MAGNUM Mechanical Flat Tappet Camshafts												
SOLID – Good for street driving. Will work w/ stock manifolds & coverter, best w/ 1800+ stall. Mild rough idle.	.022	.022	1800 to 5800	33-244-4	270S	270	270	224	224	.540	.540	110°
SOLID – Use in street machine with 2400+ stall and lower gear. 9:1 compression & headers. Rough idle.	.022	.022	2000 to 6000	33-245-4	282S	282	282	236	236	.571	.571	110°
SOLID – Good for street/strip cars. Use 10:1+ compression, low gears, 3000+ stall or 4 speed. Very rough idle.	.022	.022	2500 to 6500	33-246-4	294S	294	294	248	248	.605	.605	110°
SOLID – Excellent for Pro Street cars. 3500+ stall or 4 speed 11.5:1 compression, low gears. Radical idle.	.022	.022	3000 to 7000	33-247-4	306S	306	306	260	260	.640	.640	110°

APPLICATIONS/CAMSHAFTS	VALVE SETTING		RPM OPERATING RANGE	CAM PART #	CAM GRIND #	DURATION				VALVE LIFT		LOBE SEP. ANGLE
	IN.	EX.				ADVERTISED IN.	EX.	@ .050" IN.	EX.	W/ 1.73 ROCKER IN.	EX.	
DRAG RACE Mechanical Flat Tappet Camshafts												
SOLID – Street/strip, 9.5:1+ compression, 3000+ stall.	.028	.030	3000 to 6000	33-638-5	284B-8	284	294	246	256	.564	.590	108°
SOLID – Great torque in heavy car with 3500+ stall, 10:1 compression.	.028	.030	3500 to 6500	33-648-5	294B-8	294	304	256	266	.600	.626	108°

APPLICATIONS/CAMSHAFTS	VALVE SETTING		RPM OPERATING RANGE	CAM PART #	CAM GRIND #	DURATION				VALVE LIFT		LOBE SEP. ANGLE
	IN.	EX.				ADVERTISED IN.	EX.	@ .050" IN.	EX.	W/ 1.73 ROCKER IN.	EX.	
MAGNUM Mechanical Roller Camshafts												
MECHANICAL ROLLER – Broad powerband. Manual or automatic with 3000+ and 9.5:1 compression. Low gears. Must use headers. Rough idle.	.020	.020	2200 to 6500	33-781-9⁵	288R	292	292	243	243	.645	.645	110°
MECHANICAL ROLLER – The ultimate street cam. 3500+ stall or manual. 10.5:1 compression ratio. 4.10 gear or lower. Radical idle.	.020	.020	3000 to 7000	33-782-9⁵	308R	312	312	262	262	.674	.674	110°

FORD 427 C.I. SOHC 8 CYL. 1963-1965

APPLICATIONS/CAMSHAFTS	VALVE SETTING		RPM OPERATING RANGE	CAM PART #	CAM GRIND #	DURATION				VALVE LIFT		LOBE SEP. ANGLE
	IN.	EX.				ADVERTISED IN.	EX.	@ .050" IN.	EX.	W/ 1.825 ROCKER IN.	EX.	
SOHC Mechanical Roller Camshafts												
MECHANICAL ROLLER - Strong upgrade from stock cam for power increase and responsiveness.	.020	.020	3000 to 7000	138100	VM287R-10	287	287	264	264	.543	.543	110°
MECHANICAL ROLLER - Hot street cam with very strong torque.	.020	.020	3500 to 7500	138200	VM296R-10	296	296	272	272	.598	.598	110°

* Stub shaft available (Part #138-101-9)

² Requires machining on cylinder heads
⁵ Requires distributor gear upgrade

⁷ Stock springs cannot be used
⁴⁰ Includes special shafts

⁶⁹ Includes special rockers & shafts Part #1047-2

FORD 352-428 C.I. 8 CYL. 1963-1977 (CONTINUED)

K-KIT	SK-KIT	CL-KIT	RP-KIT	LIFTERS	TIMING SET	ROCKER ARMS	PUSHRODS	VALVE SPRINGS	RETAINERS	VALVE LOCKS	VALVE SEALS
MAGNUM Mechanical Flat Tappet Camshafts											
K33-244-4	SK33-244-4 ⁷	CL33-244-4 ⁷	N/A	835-16	2108 3108	1046-KIT ⁴⁰ 1046HD-KIT ⁶⁹	7530-16	972-16 924-16 ²	747-16 741-16	612-16	504-16 505-16 ²
K33-245-4	SK33-245-4 ⁷	CL33-245-4 ⁷	N/A	835-16	2108 3108	1046-KIT ⁴⁰ 1046HD-KIT ⁶⁹	7530-16	972-16 924-16 ²	747-16 741-16	612-16	504-16 505-16 ²
K33-246-4	SK33-246-4 ⁷	CL33-246-4 ⁷	N/A	835-16	2108 3108	1046-KIT ⁴⁰ 1046HD-KIT ⁶⁹	7530-16	924-16 ² 930-16 ²	741-16 732-16	612-16	505-16 ²
K33-247-4	SK33-247-4 ⁷	CL33-247-4 ⁷	N/A	835-16	2108 3108	1046-KIT ⁴⁰ 1046HD-KIT ⁶⁹	7530-16	924-16 ² 930-16 ²	741-16 732-16	612-16	505-16 ²

LIFTERS	TIMING SET	ROCKER ARMS	PUSHRODS	VALVE SPRINGS	RETAINERS	VALVE LOCKS	VALVE SEALS	LASH CAPS	REV KIT	DIST. GEAR	STUD GIRDLES
DRAG RACE Mechanical Flat Tappet Camshafts											
835-16	3108 3108KT	1046-KIT ⁴⁰ 1046HD-KIT ⁶⁹	7530-16	930-16 ² 928-16 ²	749-16 732-16	612-16	505-16 ²	622-16	N/A	N/A	N/A
835-16	3108 3108KT	1046-KIT ⁴⁰ 1046HD-KIT ⁶⁹	7530-16	930-16 ² 928-16 ²	749-16 732-16	612-16	505-16 ²	622-16	N/A	N/A	N/A

K-KIT	SK-KIT	CL-KIT	RP-KIT	LIFTERS	TIMING SET	ROCKER ARMS	PUSHRODS	VALVE SPRINGS	RETAINERS	VALVE LOCKS	VALVE SEALS
MAGNUM Mechanical Roller Camshafts											
K33-781-9	SK33-781-9 ⁷	CL33-781-9 ⁷	N/A	839-16	2108 3108	1046HD-KIT ⁶⁹	N/A	929-16 ² 930-16 ²	741-16 732-16	612-16	505-16 ²
K33-782-9	SK33-782-9 ⁷	CL33-782-9 ⁷	N/A	839-16	2108 3108	1046HD-KIT ⁶⁹	N/A	929-16 ² 930-16 ²	741-16 732-16	612-16	505-16 ²

FORD 427 C.I. SOHC 8 CYL. 1963-1965

K-KIT	SK-KIT	CL-KIT	RP-KIT	LIFTERS	TIMING SET	ROCKER ARMS	PUSHRODS	VALVE SPRINGS	RETAINERS	VALVE LOCKS	VALVE SEALS
SOH Mechanical Roller Camshafts											
N/A	N/A	N/A	N/A	N/A	N/A	N/A	N/A	928-16 26120-16	1732-16 1795-16	612-16	N/A
N/A	N/A	N/A	N/A	N/A	N/A	N/A	N/A	928-16 943-16	1732-16 731-16	612-16	N/A

RED NUMBERS DENOTE PREMIUM OPTION

FORD 429, 460 C.I. 8 CYL. 1968-1995

APPLICATIONS/CAMSHAFTS	VALVE SETTING		RPM OPERATING RANGE	CAM PART #	CAM GRIND #	DURATION				VALVE LIFT		LOBE SEP. ANGLE
	IN.	EX.				ADVERTISED IN.	EX.	@ .050" IN.	EX.	W/ 1.73 ROCKER IN.	EX.	
HIGH ENERGY™ Hydraulic Flat Tappet Camshafts												
HYDRAULIC – Performance upgrade for stock cam. Strong torque and mileage. Very smooth idle. Great for family sedans.	Hyd.	Hyd.	800 to 4800	34-224-4	252H	252	252	206	206	.468	.468	110°
HYDRAULIC – Great cam for trucks & towing. Strong mid-range torque & good mileage. Smooth idle.	Hyd.	Hyd.	1200 to 5200	34-225-4	260H	260	260	212	212	.484	.484	110°
HYDRAULIC – Good for everyday performance driving or heavy towing w/ low gears. Broad power, noticeable idle.	Hyd.	Hyd.	1500 to 5500	34-227-4	268H	268	268	218	218	.494	.494	110°
MAGNUM Hydraulic Flat Tappet Camshafts												
HYDRAULIC – Daily use in street machine. Largest cam with stock but will perform even better with 1800+ converter. Likes headers. Mild rough idle.	Hyd.	Hyd.	1800 to 5800	34-229-4	270H	270	270	224	224	.519	.519	110°
HYDRAULIC – Great cam for street machines. Needs 2500+ converter, headers and 9:1 compression.	Hyd.	Hyd.	2000 to 6000	34-331-4	280H	280	280	230	230	.530	.530	110°
HYDRAULIC – Street/strip use. Good power. 3000+ stall and raised compression. Very rough idle.	Hyd.	Hyd.	2500 to 6500	34-336-4	292H	292	292	244	244	.560	.560	110°
HYDRAULIC – Bracket racing or limited street use. Strong top end power. 10.5:1 compression, 3500+ stall. Radical racy idle.	Hyd.	Hyd.	3000 to 6800	34-337-4	305H	305	305	253	253	.585	.585	110°
XTREME ENERGY™ Hydraulic Flat Tappet Camshafts												
HYDRAULIC – Very strong torque through low end and mid-range. Good idle.	Hyd.	Hyd.	1000 to 5200	34-234-4	XE256H	256	268	212	218	.487	.493	110°
HYDRAULIC – Strong torque, excellent response heavy towing in 460 with 4:10 gears.	Hyd.	Hyd.	1300 to 5600	34-238-4	XE262H	262	270	218	224	.513	.520	110°
HYDRAULIC – High performance street, very strong mid-range, 2400+ stall with headers.	Hyd.	Hyd.	1800 to 6000	34-247-4	XE274H	274	286	230	236	.562	.565	110°
HYDRAULIC – Street/strip, 2800+ stall, 9.5:1 compression, lower gears, rough idle.	Hyd.	Hyd.	2300 to 6500	34-250-4	XE284H	284	296	240	246	.584	.588	110°
THUMPR™ Hydraulic Flat Tappet Camshafts												
HYDRAULIC – Thumpr™ – High performance street, stock converter ok, best with 2000+ converter and gears. Choppy/thumping idle.	Hyd.	Hyd.	2000 to 5800	34-600-5	279TH7	278	296	226	241	.506	.493	107°
HYDRAULIC – Mutha' Thumpr™ – High performance street/strip, needs 9:1 compression, 2500+ stall, intake, gears and headers, rough idle.	Hyd.	Hyd.	2200 to 6100	34-601-5	287TH7	286	304	234	249	.519	.503	107°
HYDRAULIC – Big Mutha' Thumpr™ – Street/strip, needs 9.5:1 compression, 2800+ stall, intake, gears and headers, very rough idle.	Hyd.	Hyd.	2500 to 6400	34-602-5	295TH7	294	312	242	257	.531	.515	107°

² Requires machining on cylinder heads
⁷ Stock springs cannot be used

³⁷ Adjustable valve train required

⁴¹ Use screw-in studs & guide plates. May require longer pushrods.

FORD 429, 460 C.I. 8 CYL. 1968-1995

K-KIT	SK-KIT	CL-KIT	RP-KIT	LIFTERS	TIMING SET	ROCKER ARMS	PUSHRODS	VALVE SPRINGS	RETAINERS	VALVE LOCKS	VALVE SEALS
HIGH ENERGY™ Hydraulic Flat Tappet Camshafts											
K34-224-4	SK34-224-4	CL34-224-4	N/A	832-16	3222	1411-16 ⁴¹	7834-16	940-16	743-16	601-16	502-16
K34-225-4	SK34-225-4 ⁷	CL34-225-4 ⁷	N/A	832-16	3222	1411-16 ⁴¹	7834-16	940-16	743-16	601-16	502-16
K34-227-4	SK34-227-4 ⁷	CL34-227-4 ⁷	N/A	832-16	3222	1411-16 ⁴¹	7834-16	940-16 926-16	743-16	601-16	502-16
MAGNUM Hydraulic Flat Tappet Camshafts											
K34-229-4	SK34-229-4	CL34-229-4 ⁷	N/A	832-16 862-16 ³⁷	2122 3122	1411-16 ⁴¹ 1630-16 ⁴¹	7651-16 7934-16	926-16 924-16 ²	747-16 741-16	611-16	502-16 503-16 ²
K34-331-4	SK34-331-4	CL34-331-4 ⁷	N/A	832-16 862-16 ³⁷	2122 3122	1411-16 ⁴¹ 1630-16 ⁴¹	7651-16 7934-16	926-16 924-16 ²	747-16 741-16	611-16	502-16 503-16 ²
K34-336-4	SK34-336-4 ⁷	CL34-336-4 ⁷	N/A	832-16 862-16 ³⁷	2122 3122	1411-16 ⁴¹ 1630-16 ⁴¹	7651-16 7934-16	924-16 ² 26120-16	741-16 795-16	611-16 614-16	503-16 ²
K34-337-4	SK34-337-4 ⁷	CL34-337-4 ⁷	N/A	832-16 862-16 ³⁷	2122 3122	1411-16 ⁴¹ 1630-16 ⁴¹	7651-16 7934-16	924-16 ² 26120-16	741-16 795-16	611-16 614-16	503-16 ²
XTREME ENERGY™ Hydraulic Flat Tappet Camshafts											
K34-234-4	SK34-234-4 ⁷	CL34-234-4 ⁷	N/A	832-16 862-16 ³⁷	2122 3122	1411-16 ⁴¹ 1630-16 ⁴¹	7651-16 7934-16	926-16 924-16 ²	747-16 741-16	611-16	502-16 503-16 ²
K34-238-4	SK34-238-4 ⁷	CL34-238-4 ⁷	N/A	832-16 862-16 ³⁷	2122 3122	1411-16 ⁴¹ 1630-16 ⁴¹	7651-16 7934-16	926-16 924-16 ²	747-16 741-16	611-16	502-16 503-16 ²
K34-247-4	SK34-247-4 ⁷	CL34-247-4 ⁷	N/A	832-16 862-16 ³⁷	2122 3122	1411-16 ⁴¹ 1630-16 ⁴¹	7651-16 7934-16	924-16 ² 26120-16	741-16 795-16	611-16 614-16	503-16 ²
K34-250-4	SK34-250-4 ⁷	CL34-250-4 ⁷	N/A	832-16 862-16 ³⁷	2122 3122	1411-16 ⁴¹ 1630-16 ⁴¹	7651-16 7934-16	924-16 ² 26120-16	741-16 795-16	611-16 614-16	503-16 ²
THUMPR™ Hydraulic Flat Tappet Camshafts											
K34-600-5	N/A	CL34-600-5 ⁷	N/A	832-16 862-16 ³⁷	2122 3122	1411-16 ⁴¹ 1630-16 ⁴¹	7651-16 7934-16	926-16 924-16 ²	747-16 741-16	611-16	502-16 503-16 ²
K34-601-5	N/A	CL34-601-5 ⁷	N/A	832-16 862-16 ³⁷	2122 3122	1411-16 ⁴¹ 1630-16 ⁴¹	7651-16 7934-16	926-16 924-16 ²	747-16 741-16	611-16	502-16 503-16 ²
K34-602-5	N/A	CL34-602-5 ⁷	N/A	832-16 862-16 ³⁷	2122 3122	1411-16 ⁴¹ 1630-16 ⁴¹	7651-16 7934-16	926-16 924-16 ²	747-16 741-16	611-16	502-16 503-16 ²

RED NUMBERS DENOTE PREMIUM OPTION

FORD 429, 460 C.I. 8 CYL. 1968-1995 (CONTINUED)

APPLICATIONS/CAMSHAFTS	VALVE SETTING		RPM OPERATING RANGE	CAM PART #	CAM GRIND #	DURATION				VALVE LIFT		LOBE SEP. ANGLE
	IN.	EX.				ADVERTISED IN.	EX.	@ .050" IN.	EX.	W/ 1.73 ROCKER IN.	EX.	
XTREME 4X4™ Hydraulic Flat Tappet Camshafts												
HYDRAULIC – Strong low end and mid-range torque, good idle.	Hyd.	Hyd.	1000 to 5000	34-231-4	X4256H	256	262	210	218	.514	.514	111°
HYDRAULIC – Good mid-range, largest for stock converter, heavy towing, noticeable idle. Good for daily driver.	Hyd.	Hyd.	1400 to 5600	34-235-4	X4262H	262	270	218	226	.514	.524	111°
HYDRAULIC – Likes improved intake, needs headers and 3.55-3.90 gear with 2000+ stall.	Hyd.	Hyd.	1600 to 5800	34-239-4	X4270H	270	278	226	234	.554	.574	111°
HYDRAULIC – Good top end power, needs intake, headers and gears. 9.5:1 compression w/ 2500+ stall.	Hyd.	Hyd.	2000 to 6200	34-243-5	X4278H	278	288	234	244	.574	.580	111°

APPLICATIONS/CAMSHAFTS	VALVE SETTING		RPM OPERATING RANGE	CAM PART #	CAM GRIND #	DURATION				VALVE LIFT		LOBE SEP. ANGLE
	IN.	EX.				ADVERTISED IN.	EX.	@ .050" IN.	EX.	W/ 1.6 ROCKER IN.	EX.	
XTREME MARINE™ Hydraulic Flat Tappet Camshafts												
HYDRAULIC – Strong low end and mid-range power, smooth idle.	Hyd.	Hyd.	1000 to 5200	34-232-4	XM262H	262	268	218	224	.514	.524	112°
HYDRAULIC – Strong mid-range with good throttle response, great for small blower, noticeable idle.	Hyd.	Hyd.	1600 to 5800	34-236-4	XM270H	270	286	226	236	.554	.557	112°
HYDRAULIC – Good for jet boats with A impeller. Needs good manifold, likes headers.	Hyd.	Hyd.	2000 to 6200	34-241-5	XM278H	278	292	234	244	.574	.576	112°
HYDRAULIC – Good for jet boat with A impeller. Great for skiing and performance use.	Hyd.	Hyd.	2200 to 6500	34-245-5	XM288H	288	304	244	254	.580	.585	112°
HYDRAULIC – Good for jet boat with A or B impeller. Good in bracket racing and high performance use.	Hyd.	Hyd.	2500 to 6800	34-254-5	XM298H	298	316	254	264	.585	.588	112°

MARINE Hydraulic Flat Tappet Camshafts												
APPLICATIONS/CAMSHAFTS	VALVE SETTING		RPM OPERATING RANGE	CAM PART #	CAM GRIND #	DURATION				VALVE LIFT		LOBE SEP. ANGLE
	IN.	EX.				ADVERTISED IN.	EX.	@ .050" IN.	EX.	W/ 1.6 ROCKER IN.	EX.	
HYDRAULIC – Jet boat w/ A impeller or Inboard-Outboard, good for skiing & economy. Mild idle.	Hyd.	Hyd.	1500 to 5500	34-227-4	268H	268	268	218	218	.494	.494	110°
HYDRAULIC – Jet boat with A or B impeller. Good for pleasure, skiing or performance. Rough idle.	Hyd.	Hyd.	2000 to 6000	34-331-4	280H	280	280	230	230	.530	.530	110°
HYDRAULIC – Jet boat with B impeller. Flat bottom or hydro for skiing or performance.	Hyd.	Hyd.	2500 to 6500	34-336-4	292H	292	292	244	244	.560	.560	110°
HYDRAULIC – Jet boat with B impeller. Flat bottom or hydro bracket racer. Likes tunnel ram.	Hyd.	Hyd.	3000 to 6800	34-337-4	305H	305	305	253	253	.585	.585	110°

² Requires machining on cylinder heads
⁷ Stock springs cannot be used

³⁷ Adjustable valve train required

⁴¹ Use screw-in studs & guide plates. May require longer pushrods.

FORD 429, 460 C.I. 8 CYL. 1968-1995 (CONTINUED)

K-KIT	SK-KIT	CL-KIT	RP-KIT	LIFTERS	TIMING SET	ROCKER ARMS	PUSHRODS	VALVE SPRINGS	RETAINERS	VALVE LOCKS	VALVE SEALS
XTREME 4X4™ Hydraulic Flat Tappet Camshafts											
K34-231-4	SK34-231-4 ⁷	CL34-231-4 ⁷	N/A	832-16 862-16 ³⁷	2122 3122	1411-16 ⁴¹ 1630-16 ⁴¹	7651-16 7934-16	926-16 924-16 ²	747-16 741-16	611-16	502-16 503-16 ²
K34-235-4	SK34-235-4 ⁷	CL34-235-4 ⁷	N/A	832-16 862-16 ³⁷	2122 3122	1411-16 ⁴¹ 1630-16 ⁴¹	7651-16 7934-16	926-16 924-16 ²	747-16 741-16	611-16	502-16 503-16 ²
K34-239-4	SK34-239-4 ⁷	CL34-239-4 ⁷	N/A	832-16 862-16 ³⁷	2122 3122	1411-16 ⁴¹ 1630-16 ⁴¹	7651-16 7934-16	924-16 ² 26120-16	741-16 795-16	611-16 614-16	503-16 ²
K34-243-5	SK34-243-5 ⁷	CL34-243-5 ⁷	N/A	832-16 862-16 ³⁷	2122 3122	1411-16 ⁴¹ 1630-16 ⁴¹	7651-16 7934-16	924-16 ² 26120-16	741-16 795-16	611-16 614-16	503-16 ²

K-KIT	SK-KIT	CL-KIT	RP-KIT	LIFTERS	TIMING SET	ROCKER ARMS	PUSHRODS	VALVE SPRINGS	RETAINERS	VALVE LOCKS	VALVE SEALS
XTREME MARINE™ Hydraulic Flat Tappet Camshafts											
K34-232-4	SK34-232-4 ⁷	CL34-232-4 ⁷	N/A	832-16 862-16 ³⁷	2122 3122	1411-16 ⁴¹ 1630-16 ⁴¹	7651-16 7934-16	926-16 924-16 ²	747-16 741-16	611-16	502-16 503-16 ²
K34-236-4	SK34-236-4 ⁷	CL34-236-4 ⁷	N/A	832-16 862-16 ³⁷	2122 3122	1411-16 ⁴¹ 1630-16 ⁴¹	7651-16 7934-16	924-16 ² 26120-16	741-16 795-16	611-16 614-16	503-16 ²
K34-241-5	SK34-241-5 ⁷	CL34-241-5 ⁷	N/A	832-16 862-16 ³⁷	2122 3122	1411-16 ⁴¹ 1630-16 ⁴¹	7651-16 7934-16	924-16 ² 26120-16	741-16 795-16	611-16 614-16	503-16 ²
K34-245-5	SK34-245-5 ⁷	CL34-245-5 ⁷	N/A	832-16 862-16 ³⁷	2122 3122	1411-16 ⁴¹ 1630-16 ⁴¹	7651-16 7934-16	924-16 ² 26120-16	741-16 795-16	611-16 614-16	503-16 ²
K34-254-5	SK34-254-5 ⁷	CL34-254-5 ⁷	N/A	832-16 862-16 ³⁷	2122 3122	1411-16 ⁴¹ 1630-16 ⁴¹	7651-16 7934-16	924-16 ² 26120-16	741-16 795-16	611-16 614-16	503-16 ²

MARINE Hydraulic Flat Tappet Camshafts											
K34-227-4	SK34-227-4 ⁷	CL34-227-4 ⁷	N/A	832-16 862-16 ³⁷	3222 2122	1411-16 ⁴¹ 1630-16 ⁴¹	7651-16 7934-16	940-16 926-16	747-16	611-16	502-16 503-16 ²
K34-331-4	SK34-331-4 ⁷	CL34-331-4 ⁷	N/A	832-16 862-16 ³⁷	2122 3122	1411-16 ⁴¹ 1630-16 ⁴¹	7651-16 7934-16	926-16 924-16 ²	747-16 741-16	611-16	502-16 503-16 ²
K34-336-4	SK34-336-4 ⁷	CL34-336-4 ⁷	N/A	832-16 862-16 ³⁷	2122 3122	1411-16 ⁴¹ 1630-16 ⁴¹	7651-16 7934-16	924-16 ² 26120-16	741-16 795-16	611-16 614-16	503-16 ²
K34-337-4	SK34-337-4 ⁷	CL34-337-4 ⁷	N/A	832-16 862-16 ³⁷	2122 3122	1411-16 ⁴¹ 1630-16 ⁴¹	7651-16 7934-16	924-16 ² 26120-16	741-16 795-16	611-16 614-16	503-16 ²

RED NUMBERS DENOTE PREMIUM OPTION

FORD 429, 460 C.I. 8 CYL. 1968-1995 (CONTINUED)

APPLICATIONS/CAMSHAFTS	VALVE SETTING		RPM OPERATING RANGE	CAM PART #	CAM GRIND #	DURATION				VALVE LIFT		LOBE SEP. ANGLE
	IN.	EX.				ADVERTISED IN.	EX.	@ .050" IN.	EX.	W/ 1.6 ROCKER IN.	EX.	
DUAL ENERGY™ Hydraulic Flat Tappet Camshafts												
HYDRAULIC – Good torque and mileage. Good RV and towing cam. Works with stock exhaust.	Hyd.	Hyd.	1200 to 5500	34-223-4	255DEH	255	265	203	216	.469	.495	110°
HYDRAULIC – Very strong mid-range. Everyday performance with stock exhaust.	Hyd.	Hyd.	1500 to 5750	34-226-4	265DEH	265	275	211	223	.484	.510	110°
HYDRAULIC – High performance street cam. Superior high end power. Works with stock converter, but best with 2000+ stall. Choppy idle.	Hyd.	Hyd.	2000 to 6000	34-330-4	275DEH	275	285	219	232	.515	.541	110°
XTREME ENERGY™ Computer Controlled Hydraulic Flat Tappet Camshaft (FOR EFI)												
HYDRAULIC – EFI speed density, works with stock computer. Very strong torque, excellent mileage, good idle quality.	Hyd.	Hyd.	1000 to 5200	34-255-5	XE256H-14	256	268	212	219	.490	.495	114°

APPLICATIONS/CAMSHAFTS	VALVE SETTING		RPM OPERATING RANGE	CAM PART #	CAM GRIND #	DURATION				VALVE LIFT		LOBE SEP. ANGLE
	IN.	EX.				ADVERTISED IN.	EX.	@ .050" IN.	EX.	W/ 1.73 ROCKER IN.	EX.	
DRAG RACE Hydraulic Flat Tappet Camshaft												
HYDRAULIC – Great for heavy car with 3500+ stall and 10.5:1+ compression.	Hyd.	Hyd.	3800 to 6800	34-338-5	312H-10	312	312	260	260	.610	.610	110°

APPLICATIONS/CAMSHAFTS	VALVE SETTING		RPM OPERATING RANGE	CAM PART #	CAM GRIND #	DURATION				VALVE LIFT		LOBE SEP. ANGLE
	IN.	EX.				ADVERTISED IN.	EX.	@ .050" IN.	EX.	W/ 1.73 ROCKER IN.	EX.	
XTREME ENERGY™ Retro-Fit Hydraulic Roller Camshafts												
HYDRAULIC ROLLER – Great mid-range torque in performance street application, likes headers.	Hyd.	Hyd.	1800-5400	34-422-9	XR270HR	270	276	218	224	.521	.521	110°
HYDRAULIC ROLLER – High performance for street cars with 2200+ stall, 9:1+ compression, headers.	Hyd.	Hyd.	2200-5800	34-432-9	XR280HR	282	288	230	236	.521	.532	110°
HYDRAULIC ROLLER – Street/strip applications, 10:1+ compression, 3000+ stall, intake, headers, gear.	Hyd.	Hyd.	2800-6100	34-443-9	XR294HR	294	300	242	248	.553	.572	110°

APPLICATIONS/CAMSHAFTS	VALVE SETTING		RPM OPERATING RANGE	CAM PART #	CAM GRIND #	DURATION				VALVE LIFT		LOBE SEP. ANGLE
	IN.	EX.				ADVERTISED IN.	EX.	@ .050" IN.	EX.	W/ 1.6 ROCKER IN.	EX.	
THUMPR™ Retro-Fit Hydraulic Roller Camshafts												
HYDRAULIC ROLLER – Thumpr™ – High performance street, stock converter ok, best with 2000+ converter and gears, choppy/thumping idle.	Hyd.	Hyd.	1900 to 5600	34-600-9	283THR7	283	303	227	241	.557	.539	107°
HYDRAULIC ROLLER – Mutha' Thumpr™ – High performance street/strip, needs 9:1 compression, 2500+ stall, intake, gears and headers, rough idle.	Hyd.	Hyd.	2200 to 5900	34-601-9	291THR7	291	311	235	249	.567	.551	107°
HYDRAULIC ROLLER – Big Mutha' Thumpr™ – Street/ strip, needs 9.5:1 compression, 2800+ stall, intake, gears and headers, very rough idle.	Hyd.	Hyd.	2500 to 6200	34-602-9	299THR7	299	319	243	257	.579	.563	107°

² Requires machining on cylinder heads
⁷ Stock springs cannot be used

³⁷ Adjustable valve train required

⁴¹ Use screw-in studs & guide plates. May require longer pushrods.

FORD 429, 460 C.I. 8 CYL. 1968-1995 (CONTINUED)

K-KIT	SK-KIT	CL-KIT	RP-KIT	LIFTERS	TIMING SET	ROCKER ARMS	PUSHRODS	VALVE SPRINGS	RETAINERS	VALVE LOCKS	VALVE SEALS
DUAL ENERGY™ Hydraulic Flat Tappet Camshafts											
K34-223-4	SK34-223-4 ⁷	CL34-223-4 ⁷	N/A	832-16 862-16 ³⁷	2122 3122	1411-16 ⁴¹ 1630-16 ⁴¹	7651-16 7934-16	926-16 924-16 ²	747-16 741-16	611-16	502-16 503-16 ²
K34-226-4	SK34-226-4 ⁷	CL34-226-4 ⁷	N/A	832-16 862-16 ³⁷	2122 3122	1411-16 ⁴¹ 1630-16 ⁴¹	7651-16 7934-16	926-16 924-16 ²	747-16 741-16	611-16	502-16 503-16 ²
K34-330-4	SK34-330-4 ⁷	CL34-330-4 ⁷	N/A	832-16 862-16 ³⁷	2122 3122	1411-16 ⁴¹ 1630-16 ⁴¹	7651-16 7934-16	926-16 924-16 ²	747-16 741-16	611-16	502-16 503-16 ²
XTREME ENERGY™ Computer Controlled Hydraulic Flat Tappet Camshaft (FOR EFI)											
N/A	N/A	N/A	N/A	832-16 862-16 ³⁷	2122 3122	1411-16 ⁴¹ 1630-16 ⁴¹	7651-16 7934-16	926-16 924-16 ²	747-16 741-16	611-16	502-16 503-16 ²

LIFTERS	TIMING SET	ROCKER ARMS	PUSHRODS	VALVE SPRINGS	RETAINERS	VALVE LOCKS	VALVE SEALS	LASH CAPS	REV KIT	DIST. GEAR	STUD GIRDLES
DRAG RACE Hydraulic Flat Tappet Camshaft											
862-16 ³⁷	3122	1630-16 ⁴¹	7934-16	928-16 ²	741-16	611-16	503-16 ²	621-16	N/A	432	4034 ⁷²

K-KIT	SK-KIT	CL-KIT	RP-KIT	LIFTERS	TIMING SET	ROCKER ARMS	PUSHRODS	VALVE SPRINGS	RETAINERS	VALVE LOCKS	VALVE SEALS
XTREME ENERGY™ Retro-Fit Hydraulic Roller Camshafts											
K34-422-9	N/A	CL34-422-9 ⁷	N/A	8934-16	2122 3122	1411-16 ⁴¹ 1630-16 ⁴¹	7740-16	924-16 ² 26120-16	741-16 795-16	611-16 614-16	503-16 ²
K34-432-9	N/A	CL34-432-9 ⁷	N/A	8934-16	2122 3122	1411-16 ⁴¹ 1630-16 ⁴¹	7740-16	924-16 ² 26120-16	741-16 795-16	611-16 614-16	503-16 ²
K34-443-9	N/A	CL34-443-9 ⁷	N/A	8934-16	2122 3122	1411-16 ⁴¹ 1630-16 ⁴¹	7740-16	924-16 ² 26120-16	741-16 795-16	611-16 614-16	503-16 ²

K-KIT	SK-KIT	CL-KIT	RP-KIT	LIFTERS	TIMING SET	ROCKER ARMS	PUSHRODS	VALVE SPRINGS	RETAINERS	VALVE LOCKS	VALVE SEALS
THUMPR™ Retro-Fit Hydraulic Roller Camshafts											
K34-600-9	N/A	CL34-600-9 ⁷	N/A	8934-16	2122 3122	1411-16 ⁴¹ 1630-16 ⁴¹	N/A	924-16 ² 26120-16	741-16 795-16	611-16 614-16	503-16 ²
K34-601-9	N/A	CL34-601-9 ⁷	N/A	8934-16	2122 3122	1411-16 ⁴¹ 1630-16 ⁴¹	N/A	924-16 ² 26120-16	741-16 795-16	611-16 614-16	503-16 ²
K34-602-9	N/A	CL34-602-9 ⁷	N/A	8934-16	2122 3122	1411-16 ⁴¹ 1630-16 ⁴¹	N/A	924-16 ² 26120-16	741-16 795-16	611-16 614-16	503-16 ²

⁷² Fits only certain heads

FORD 429, 460 C.I. 8 CYL. 1968-1995 (CONTINUED)

APPLICATIONS/CAMSHAFTS	VALVE SETTING		RPM OPERATING RANGE	CAM PART #	CAM GRIND #	DURATION				VALVE LIFT		LOBE SEP. ANGLE
	IN.	EX.				ADVERTISED IN.	EX.	@ .050" IN.	EX.	W/ 1.73 ROCKER IN.	EX.	
MAGNUM Mechanical Flat Tappet Camshafts												
SOLID – Great for daily use. Good mid-range power. Stock converter and compression. Noticeable idle.	.022	.022	1800 to 5800	34-340-4	270S	270	270	224	224	.540	.540	110°
SOLID – Good for street machine w/ 2000+ converter and headers. 9:1+ compression. Mild rough idle.	.022	.022	2000 to 6000	34-341-4	282S	282	282	236	236	.570	.570	110°
SOLID – Good street/strip cam. Excellent power. 3000+ stall w/ manifolds & 9.5:1+ compression. Radical idle.	.022	.022	2500 to 6500	34-342-4	294S	294	294	248	248	.605	.605	110°
SOLID – Bracket race or limited street use. Must have low gear w/ 3500+ stall. 10.5:1 compression. Racy idle.	.022	.022	3000 to 6800	34-343-4	306S	306	306	260	260	.640	.640	110°

APPLICATIONS/CAMSHAFTS	VALVE SETTING		RPM OPERATING RANGE	CAM PART #	CAM GRIND #	DURATION				VALVE LIFT		LOBE SEP. ANGLE
	IN.	EX.				ADVERTISED IN.	EX.	@ .050" IN.	EX.	W/ 1.73 ROCKER IN.	EX.	
MARINE Mechanical Flat Tappet Camshafts												
SOLID – Jet boat A impeller, hydro or flat bottom river racer. Use tunnel ram.	.030	.030	4000 to 7000	34-653-5	310B-8	310	314	270	276	.649	.642	108°
SOLID – Hydro or flat bottom with two 4 BBL on tunnel ram. Good for bracket racing.	.030	.030	5000 to 7500	34-661-5	320B-8	320	324	280	286	.645	.666	108°

DRAG RACE Mechanical Flat Tappet Camshafts												
SOLID – Excellent torque. Works well with 4000 stall, heavy car. 10:1+ compression.	.030	.030	3500 to 6500	34-652-5	294B-8	294	304	256	266	.589	.615	108°
SOLID – 4 speed or 4500 stall in 460c.i. and 5000 stall in 429. 11:1+ compression.	.030	.030	4000 to 6800	34-653-5	310B-8	310	314	270	276	.649	.642	108°

APPLICATIONS/CAMSHAFTS	VALVE SETTING		RPM OPERATING RANGE	CAM PART #	CAM GRIND #	DURATION				VALVE LIFT		LOBE SEP. ANGLE
	IN.	EX.				ADVERTISED IN.	EX.	@ .050" IN.	EX.	W/ 1.6 ROCKER IN.	EX.	
MAGNUM Mechanical Roller Camshafts												
MECHANICAL ROLLER – Street/strip performance, 10:1+ compression, 2200+ stall, headers, choppy idle.	.020	.020	2500 to 6500	34-700-9⁵	280A-R10	280	280	236	236	.634	.634	110°
MECHANICAL ROLLER – Ultimate Pro Street cam 4000+ stall/4 speed, 11:1+ compression, radical idle.	.020	.020	3200 to 7200	34-710-9⁵	300A-R10	300	300	255	255	.663	.663	110°
XTREME ENERGY™ Mechanical Roller Camshafts												
MECHANICAL ROLLER – Great for reliable power touring. 2500+ stall, easy on parts, rough idle.	.016	.018	2200 to 6200	34-770-9⁵	XR274R-10	274	280	236	242	.650	.657	110°
MECHANICAL ROLLER – Best in street machines, 2800 stall, 10:1+ compression, 3.73-3.90 gears.	.016	.018	2500 to 6500	34-771-9⁵	XR280R-10	280	286	242	248	.657	.664	110°
MECHANICAL ROLLER – Great for weekend warrior, 3000+ stall, needs intake, exhaust, gears.	.016	.018	3000 to 7000	34-772-9⁵	XR286R-10	286	292	248	254	.664	.671	110°
MECHANICAL ROLLER – Best for Pro Street, 3500+ stall. Needs good intake and exhaust, 11:1+ compression.	.016	.018	3200 to 7200	34-773-9⁵	XR292R-10	292	298	254	260	.671	.678	110°

² Requires machining on cylinder heads
⁵ Requires distributor gear upgrade

⁷ Stock springs cannot be used

⁴¹ Use screw-in studs & guide plates. May require longer pushrods.

FORD 429, 460 C.I. 8 CYL. 1968-1995 (CONTINUED)

K-KIT	SK-KIT	CL-KIT	RP-KIT	LIFTERS	TIMING SET	ROCKER ARMS	PUSHRODS	VALVE SPRINGS	RETAINERS	VALVE LOCKS	VALVE SEALS	
MAGNUM Mechanical Flat Tappet Camshafts												
K34-340-4	SK34-340-4 ⁷	CL34-340-4 ⁷	N/A	833-16 817-16	2122 3122	1411-16 ⁴¹ 1630-16 ⁴¹	7651-16 7934-16	926-16 924-16 ²	747-16 741-16	611-16	502-16 503-16 ²	
K34-341-4	SK34-341-4 ⁷	CL34-341-4 ⁷	N/A	833-16 817-16	2122 3122	1411-16 ⁴¹ 1630-16 ⁴¹	7651-16 7934-16	924-16 ² 26120-16	741-16 795-16	611-16 614-16	503-16 ²	
K34-342-4	SK34-342-4 ⁷	CL34-342-4 ⁷	N/A	833-16 817-16	2122 3122	1411-16 ⁴¹ 1630-16 ⁴¹	7651-16 7934-16	924-16 ² 930-16 ²	741-16 732-16	611-16	503-16 ²	
K34-343-4	SK34-343-4 ⁷	CL34-343-4	N/A	833-16 817-16	2122 3122	1411-16 ⁴¹ 1630-16 ⁴¹	7651-16 7934-16	924-16 ² 930-16 ²	741-16 732-16	611-16	503-16 ²	

LIFTERS	TIMING SET	ROCKER ARMS	PUSHRODS	VALVE SPRINGS	RETAINERS	VALVE LOCKS	VALVE SEALS	LASH CAPS	REV KIT	DIST. GEAR	STUD GIRDLES
MARINE Mechanical Flat Tappet Camshafts											
833-16 817-16	3122	1630-16 ⁴¹ 1830-16 ⁴¹	7934-16	930-16 ²	741-16 732-16	611-16	503-16 ²	621-16	N/A	432	4034
833-16 817-16	3122	1630-16 ⁴¹ 1830-16 ⁴¹	7934-16	930-16 ²	741-16 732-16	611-16	503-16 ²	621-16	N/A	432	4034

DRAG RACE Mechanical Flat Tappet Camshafts											
833-16 817-16	3122	1630-16 ⁴¹ 1830-16 ⁴¹	7934-16	930-16 ²	741-16 732-16	611-16	503-16 ²	621-16	N/A	432	4034
833-16 817-16	3122	1630-16 ⁴¹ 1830-16 ⁴¹	7934-16	930-16 ²	741-16 732-16	611-16	503-16 ²	621-16	N/A	432	4034

K-KIT	SK-KIT	CL-KIT	DIST. GEAR	LIFTERS	TIMING SET	ROCKER ARMS	PUSHRODS	VALVE SPRINGS	RETAINERS	VALVE LOCKS	VALVE SEALS
MAGNUM Mechanical Roller Camshafts											
K34-700-9	N/A	CL34-700-9 ⁷	432	836-16	2122 3122	1630-16 ⁴¹ 1830-16 ⁴¹	7934-16	954-16	741-16 732-16	611-16	503-16 ²
K34-710-9	N/A	CL34-710-9 ⁷	432	836-16	2122 3122	1630-16 ⁴¹ 1830-16 ⁴¹	7934-16	954-16	741-16 732-16	611-16	503-16 ²
XTREME ENERGY™ Mechanical Roller Camshafts											
K34-770-9	N/A	CL34-770-9 ⁷	432	836-16	2122 3122	1630-16 ⁴¹ 1830-16 ⁴¹	7934-16	954-16	741-16 732-16	611-16	503-16 ²
K34-771-9	N/A	CL34-771-9 ⁷	432	836-16	2122 3122	1630-16 ⁴¹ 1830-16 ⁴¹	7934-16	954-16	741-16 732-16	611-16	503-16 ²
K34-772-9	N/A	CL34-772-9 ⁷	432	836-16	2122 3122	1630-16 ⁴¹ 1830-16 ⁴¹	7934-16	954-16	741-16 732-16	611-16	503-16 ²
K34-773-9	N/A	CL34-773-9 ⁷	432	836-16	2122 3122	1630-16 ⁴¹ 1830-16 ⁴¹	7934-16	954-16	741-16 732-16	611-16	503-16 ²

RED NUMBERS DENOTE PREMIUM OPTION

FORD 429, 460 C.I. 8 CYL. 1968-1995 (CONTINUED)

APPLICATIONS/CAMSHAFTS	VALVE SETTING		RPM OPERATING RANGE	CAM PART #	CAM GRIND #	DURATION				VALVE LIFT		LOBE SEP. ANGLE
	IN.	EX.				ADVERTISED IN.	EX.	@ .050" IN.	EX.	W/ 1.73 ROCKER IN.	EX.	
MARINE Mechanical Roller Camshafts												
MECHANICAL ROLLER – Blown alcohol or blown gas. Use in 500c.i. or larger engine.	.028	.030	4400 to 7200	34-850-9⁵	308AR-12	308	316	272	279	.727	.727	112°
MECHANICAL ROLLER – Good for unblown gas or alcohol. Two 4 BBL or injection.	.030	.030	5500 to 7500	34-746-9⁵	319CR-10	319	326	285	288	.796	.726	110°
MECHANICAL ROLLER – Pro Stock style engine, 500c.i. or larger, Boss, SVO or TFS heads.	.028	.030	6000 to 8500	34-803-9⁵	327DR-12	327	342	290	302	.796	.796	112°
PULLER & MUD RACE Mechanical Roller Camshafts												
MECHANICAL ROLLER – Great torque and power in 429-460, single carb., 10:1+ compression.	.028	.030	3500 to 6500	34-711-9⁵	288BR-8	288	296	252	260	.726	.726	108°
MECHANICAL ROLLER – Works best in 460 or larger engine with 11:1 compression and tunnel ram.	.028	.030	3800 to 7200	34-720-9⁵	306AR-8	306	306	271	271	.692	.692	108°
DRAG RACE Mechanical Roller Camshafts												
MECHANICAL ROLLER – Excellent torque for heavy car, 4000+ stall, 10:1+ compression.	.028	.030	3800 to 6800	34-713-9⁵	296BR-8	296	304	260	268	.726	.726	108°
MECHANICAL ROLLER – Great power, 11:1+ compression with 4500+ stall.	.028	.030	3800 to 6800	34-715-9⁵	304BR-8	304	312	268	276	.726	.726	108°
MECHANICAL ROLLER – 500c.i., use with good heads and large carb.	.030	.030	4800 to 7500	34-740-9⁵	313CR-10	313	319	275	284	.806	.763	110°
MECHANICAL ROLLER – Use in large engine with 11.5+ compression and 5000+ stall.	.028	.030	4800 to 7500	34-703-9⁵	312BR-10	312	319	276	280	.726	.692	110°
MECHANICAL ROLLER – 5500+ stall or 4 speed in light car. 460 and larger engine.	.030	.030	5500-7500	34-746-9⁵	319CR-10	319	326	285	288	.796	.726	110°
MECHANICAL ROLLER – 650+ c.i., 2500+ lbs with Lenco, works with nitrous.	.028	.030	5500 to 8500	34-814-9⁵	324FR-120	326	360	292	320	.882	.830	120°
MECHANICAL ROLLER – 550+ c.i., engines 2300+ lbs, manual transmission.	.028	.030	6000 to 8500	34-812-9⁵	324FR-18	324	360	289	320	.882	.830	118°
MECHANICAL ROLLER – Top Sportsman 500c.i. with all best components.	.026	.028	7000 to 9000	34-810-9⁵	324DR-14	324	352	289	312	.882	.825	114°
MECHANICAL ROLLER – Top Sportsman 500c.i. with manual transmission in light car.	.028	.030	7000 to 9000	34-789-9⁵	328OR-16	328	356	288	316	.836	.830	116°

² Requires machining on cylinder heads
⁵ Requires distributor gear upgrade

⁴¹ Use screw-in studs & guide plates. May require longer pushrods.

⁷² Fits only certain heads

FORD 429, 460 C.I. 8 CYL. 1968-1995 (CONTINUED)

LIFTERS	TIMING SET	ROCKER ARMS	PUSHRODS	VALVE SPRINGS	RETAINERS	VALVE LOCKS	VALVE SEALS	LASH CAPS	REV KIT	DIST. GEAR	STUD GIRDLES	
MARINE Mechanical Roller Camshafts												
836-16	3122 7122	1630-16 ⁴¹ 1830-16 ⁴¹	7934-16	959-16 947-16 ²	733-16 739-16	611-16	503-16 ² 506-16 ²	621-16	N/A	432	4034	
836-16	3122 7122	1630-16 ⁴¹ 1830-16 ⁴¹	7934-16	959-16 947-16 ²	733-16 739-16	611-16	503-16 ² 506-16 ²	621-16	N/A	432	4034	
836-16	3122 7122	1630-16 ⁴¹ 1830-16 ⁴¹	7934-16	959-16 947-16 ²	733-16 739-16	611-16	503-16 ² 506-16 ²	621-16	N/A	432	4034	
PULLER & MUD RACE Mechanical Roller Camshafts												
836-16	3122 7122	1630-16 ⁴¹ 1830-16 ⁴¹	7934-16	959-16 947-16 ²	733-16 739-16	611-16	503-16 ² 506-16 ²	621-16	N/A	432	4034	
836-16	3122 7122	1630-16 ⁴¹ 1830-16 ⁴¹	7934-16	959-16 947-16 ²	733-16 739-16	611-16	503-16 ² 506-16 ²	621-16	N/A	432	4034	
DRAG RACE Mechanical Roller Camshafts												
836-16	3122 7122	1630-16 ⁴¹ 1830-16 ⁴¹	7934-16	947-16 ²	739-16	611-16	503-16 ² 506-16 ²	621-16	N/A	432	4034	
836-16	3122 7122	1630-16 ⁴¹ 1830-16 ⁴¹	7934-16	959-16 947-16 ²	739-16	611-16	503-16 ² 506-16 ²	621-16	N/A	432	4034	
836-16	3122 7122	1630-16 ⁴¹ 1830-16 ⁴¹	7934-16	947-16 ²	739-16	611-16	503-16 ² 506-16 ²	621-16	N/A	432	4034	
836-16	3122 7122	1630-16 ⁴¹ 1830-16 ⁴¹	7934-16	959-16 947-16 ²	739-16	611-16	503-16 ² 506-16 ²	621-16	N/A	432	4034	
836-16	3122 7122	1630-16 ⁴¹ 1830-16 ⁴¹	7934-16	947-16 ²	739-16	611-16	503-16 ² 506-16 ²	621-16	N/A	432	4034 4017 ⁷²	
836-16	3122 7122	1630-16 ⁴¹ 1830-16 ⁴¹	7934-16	947-16 ²	739-16	611-16	503-16 ² 506-16 ²	621-16	N/A	432	4034 4017 ⁷²	
836-16	3122 7122	1630-16 ⁴¹ 1830-16 ⁴¹	7934-16	947-16 ²	739-16	611-16	503-16 ² 506-16 ²	621-16	N/A	432	4034 4017 ⁷²	
836-16	3122 7122	1630-16 ⁴¹ 1830-16 ⁴¹	7934-16	947-16 ²	739-16	611-16	503-16 ² 506-16 ²	621-16	N/A	432	4034 4017 ⁷²	

RED NUMBERS DENOTE PREMIUM OPTION

Small Block and Big Block Chevrolet engines have become legendary since they were introduced over 50 years ago. COMP Cams®, along with the help of top engine builders, has spent many years improving these and other Chevrolet power plants. We know the basics. And the basics are important. If you require assistance or have any questions, there are several ways we can be reached.

ENGINE TYPES

V6 90°

V6, Uses "18", "09" & "56" Prefixes

The 4.3L V6 90° engines produced since 1985 are equipped with two types of camshafts and three types of cam drive systems. Early 1985 and 1986 engines (Prefix "18") were produced with flat tappet cams. Hydraulic roller cams were first introduced in 1987 (Prefix "09"). These two cam types require different timing chain sets, because the hydraulic roller cams have a stepped nose like the LT1 engine as described later in this section. In 1992, a balance shaft was incorporated in this engine, which necessitated a third timing chain setup to drive both the cam and the balance shaft. The cam (Prefix "56") in this balance shaft engine is also shorter than the earlier model and does not have a fuel pump lobe.

SMALL BLOCK V8

There are several varieties of small block engines currently in use in the aftermarket. Although most use the same block, the cylinder heads are very different and require totally different camshafts. The valve arrangements in the heads are different, and therefore the lobe placement on the camshafts must coincide with the head you are using.

the block to accommodate a cam retention thrust plate and the anti-rotation mechanism for the hydraulic roller lifters. These blocks are identifiable by bolt holes for a cam retention plate behind the upper timing sprocket, as well as bosses and tapped holes in the lifter valley for the lifter retention hardware. The camshafts on these engines have a step nose and smaller bolt pattern on the front of them cam. An earlier model camshaft may be used in these blocks by using the appropriate timing chain set and adding a thrust button when using a roller cam.

LT1 & LT4 Engines, Use "07" Prefix

These engines are, as far as the camshaft is concerned, essentially the same as the hydraulic roller engines, with one exception. The distributor is driven from the front of the cam, requiring some changes in the cam core. There is a deeper pilot hole in the front of the cam, as well as a longer dowel pin to locate this drive. These engines require a special timing chain set, and they utilize a self-aligning rocker arm. COMP Cams® LT1 and LT4 Magnum Rocker Arms can be found on page 271.



The nose of the standard early model cam "12" is very different from the later model hydraulic roller "08". The nose of the hydraulic roller "08" is necked down to accommodate the cam retention plate. The "07" is an LT1/LT4 shaft, which has a longer dowel pin and a center hole for the distributor. Be sure to check the diameter and depth of the hole in the front, as well as the length of the dowel pin.

COMP Cams® Standard Small Block, Uses "12" Prefix

This design is the same basic small block that everyone is accustomed to. This engine configuration is found on all small blocks from 1955 until 1987, when Chevrolet introduced the roller cam. Based on the original 1955 version, with the exception of the 1955-1957 versions, which had an oiling groove in the rear journal, the camshafts are interchangeable.

Hydraulic Roller, Uses "08" Prefix

Beginning in 1987, most of the small block, (both V6 and V8) engines were equipped with hydraulic roller camshafts. There are differences in

Other Variations

Buick made a small block cylinder head with a different valve arrangement in the early 1980s, "19" prefix. It is still used in some drag racing and circle track applications today. GM also produced a true race engine called the SB2. It also has a different valve arrangement. When using this head with a standard GM block use prefix "03". There is also a special SB2 block design that would require the "04" prefix.

LS SERIES, USES "54," "146," "646," "156," "656," "189" AND "689" PREFIXES

This series of engines is the first real departure from GM's original small block design. Almost none of the parts carry over from previous engines. There are many new parts available in the aftermarket. The camshaft is a steel roller cam, approximately 4" shorter and .300" larger in diameter, so there should be no problem distinguishing these cams from the older style GM cams. There are several different core designs that vary based on bolt holes, Variable Valve Timing (VVT) and AFM (Active Fuel Management) and cam actuator part numbers. See our GM LS Application Chart on pages 162-165 if you need assistance in identifying your LS engine type.



GEN III/IV THREE-BOLT CAM

GEN IV SINGLE-BOLT W/O VVT CAM

GEN IV SINGLE-BOLT W/ VVT CAM



CAMSHAFTS GENERAL MOTORS

BIG BLOCK V8

Big Block, Uses "11" Prefix

Gen VI Big Block, Uses "01" Prefix

8.1L Big Block, Uses "46" Prefix

This engine was introduced in 1965 and with the exception of some of the very early 1965-1966 models that had an oiling groove in the rear journal, the camshafts are interchangeable. This includes all of the big blocks, including the Mark V, with nearly every style cylinder head until the Gen VI was introduced in 1996.

The Gen VI version 454-502 Big Block is very similar to the earlier standard big block engine. The heads are interchangeable, but there is a non-adjustable valve train. It is equipped with a hydraulic roller camshaft. There is also a positive camshaft retaining plate on the front, and the nose of the cam is stepped down to accept this plate. The lifter bosses are taller to accommodate the lifter anti-rotation plates, and the engine requires a special timing chain set.

The 8.1L Big Block has many differences from the previous designs. The parts are not interchangeable and it utilizes a different firing order as well.

OLDER ENGINES

The very first 1955-1957 265c.i. Small Blocks had a unique oiling system. The same holds true for the first 1965 and 1966 396/427 Big Blocks. When one of these blocks is used, it is necessary to machine a small groove in the rear journal of the cam to allow oil flow to the top of the engine.

COMP Cams® camshafts come without this groove, so it is important to check the vintage of your block prior to camshaft installation. COMP Cams® can perform this operation or supply the specs to you for local machining.

GENERAL TIPS

HYDRAULIC ROLLER CAMS

When installing a hydraulic roller cam in an early model block, it is necessary to use a special hydraulic roller lifter with a link bar attached to keep the lifters properly located within the block. In addition, special length pushrods must also be used. A thrust button must also be used to keep the cam from "walking" in the block.

When installing a flat tappet cam in a block originally equipped with a hydraulic roller, it is necessary to change the entire system. The cam, lifters, pushrods and timing chain set must all be changed in this case; none of the old parts will interchange.



HAVE QUESTIONS?
WE CAN HELP YOU

Just Call Our
Toll Free Tech Line

CAMHELP®
800.999.0853

BUICK 181-252 C.I. EVEN FIRE 6 CYL. 1978-1988

APPLICATIONS/CAMSHAFTS	VALVE SETTING		RPM OPERATING RANGE	CAM PART #	CAM GRIND #	DURATION				VALVE LIFT		LOBE SEP. ANGLE
	IN.	EX.				ADVERTISED IN.	EX.	@ .050" IN.	EX.	W/ 1.55 ROCKER IN.	EX.	
HIGH ENERGY™ Hydraulic Flat Tappet Camshafts												
HYDRAULIC – Excellent performance upgrade for stock camshaft. Good mileage & torque. Smooth idle.	Hyd.	Hyd.	800 to 4200	69-115-4	240H	240	248	192	200	.403	.403	110°
HYDRAULIC – Good power for light towing or use with high gear ratios. Smooth idle.	Hyd.	Hyd.	1000 to 4800	69-234-4	252H	252	252	206	206	.425	.425	110°
HYDRAULIC – Ideal for towing. Strong mid-range power, especially at highway speeds.	Hyd.	Hyd.	1400 to 5400	69-235-4	260H	260	260	212	212	.456	.456	110°
HYDRAULIC – Performance cam for the street. Mild choppy idle. Likes lower gears.	Hyd.	Hyd.	1800 to 5800	69-246-4	268H	268	268	218	218	.469	.469	110°

BUICK 198-225 C.I. ODD FIRE 6 CYL. 1962-1967

APPLICATIONS/CAMSHAFTS	VALVE SETTING		RPM OPERATING RANGE	CAM PART #	CAM GRIND #	DURATION				VALVE LIFT		LOBE SEP. ANGLE
	IN.	EX.				ADVERTISED IN.	EX.	@ .050" IN.	EX.	W/ 1.55 ROCKER IN.	EX.	
HIGH ENERGY™ Hydraulic Flat Tappet Camshafts												
HYDRAULIC – Excellent torque & economy. Good performance upgrade for stock cam. Smooth idle.	Hyd.	Hyd.	1000 to 4800	63-234-4	252H	252	252	206	206	.438	.438	110°
HYDRAULIC – Great for towing. Good power at highway speeds. Near smooth idle.	Hyd.	Hyd.	1400 to 5400	63-235-4	260H	260	260	212	212	.454	.454	110°
HYDRAULIC – Performance street cam with broad powerband. Slightly rough idle.	Hyd.	Hyd.	1800 to 5800	63-246-4	268H	268	268	218	218	.468	.468	110°

BUICK GRAND NATIONAL 231 C.I. 6 CYL. 1977½-1987, 1988-1989 TRANS AM

APPLICATIONS/CAMSHAFTS	VALVE SETTING		RPM OPERATING RANGE	CAM PART #	CAM GRIND #	DURATION				VALVE LIFT		LOBE SEP. ANGLE
	IN.	EX.				ADVERTISED IN.	EX.	@ .050" IN.	EX.	W/ 1.55 ROCKER IN.	EX.	
HIGH ENERGY™ Hydraulic Flat Tappet Turbo Camshafts												
HYDRAULIC – Good replacement for turbo charged Grand National.	Hyd.	Hyd.	1200 to 5500	69-248-4	260H	260	260	212	212	.459	.459	112°
HIGH ENERGY™ Hydraulic Roller Turbo Camshafts												
HYDRAULIC ROLLER – Good performance upgrade for stock camshaft. Works with stock computer.	Hyd.	Hyd.	800 to 5200	69-200-8	258HR	258	258	206	206	.496	.496	110°
HYDRAULIC ROLLER – Stock or aftermarket turbo. Downpipe and computer modifications.	Hyd.	Hyd.	1200 to 5800	69-300-8	264HR	264	264	212	212	.504	.504	110°
HYDRAULIC ROLLER – Performance upgrade for use with aftermarket turbo. Downpipe, intercooler preferred. Needs computer modifications or aftermarket computer.	Hyd.	Hyd.	1500 to 6200	69-400-8	269HR	269	264	218	212	.511	.504	112°

² Requires machining on cylinder heads

⁷ Stock springs cannot be used

⁸¹ Some early applications use larger diameter lifters and non-oiling pushrods

BUICK 181-252 C.I. EVEN FIRE 6 CYL. 1978-1988

K-KIT	SK-KIT	CL-KIT	RP-KIT	LIFTERS	TIMING SET	ROCKER ARMS	PUSHRODS	VALVE SPRINGS	RETAINERS	VALVE LOCKS	VALVE SEALS
HIGH ENERGY™ Hydraulic Flat Tappet Camshafts											
K69-115-4*	SK69-115-4	CL69-115-4	N/A	869-12	3226	N/A	7869-12	980-12	742-12	601-12	502-12
K69-234-4*	SK69-234-4	CL69-234-4	N/A	869-12	3226	N/A	7869-12	980-12	742-12	601-12	502-12
K69-235-4*	SK69-235-4 ⁷	CL69-235-4 ⁷	N/A	869-12	3226	N/A	7869-12	980-12	742-12	601-12	502-12
K69-246-4*	SK69-246-4 ⁷	CL69-246-4 ⁷	N/A	869-12	3226	N/A	7869-12	980-12	742-12	601-12	502-12

* K-Kit only includes cam, lifters, valve springs, timing set and seals.

BUICK 198-225 C.I. ODD FIRE 6 CYL. 1962-1967

K-KIT	SK-KIT	CL-KIT	RP-KIT	LIFTERS	TIMING SET	ROCKER ARMS	PUSHRODS	VALVE SPRINGS	RETAINERS	VALVE LOCKS	VALVE SEALS
HIGH ENERGY™ Hydraulic Flat Tappet Camshafts											
K63-234-4*	SK63-234-4	CL63-234-4	N/A	869-12 ⁸¹	3215	N/A	7869-12 ⁸¹	980-12	742-12	601-12	502-12
K63-235-4*	SK63-235-4 ⁷	CL63-235-4 ⁷	N/A	869-12 ⁸¹	3215	N/A	7869-12 ⁸¹	980-12	742-12	601-12	502-12
K63-246-4*	SK63-246-4 ⁷	CL63-246-4 ⁷	N/A	869-12 ⁸¹	3215	N/A	7869-12 ⁸¹	980-12	742-12	601-12	502-12

* K-Kit only includes cam, lifters, valve springs, timing set and seals.

BUICK GRAND NATIONAL 231 C.I. 6 CYL. 1977½-1987, 1988-1989 TRANS AM

K-KIT	SK-KIT	CL-KIT	RP-KIT	LIFTERS	TIMING SET	ROCKER ARMS	PUSHRODS	VALVE SPRINGS	RETAINERS	VALVE LOCKS	VALVE SEALS
HIGH ENERGY™ Hydraulic Flat Tappet Turbo Camshafts											
K69-248-4*	SK69-248-4 ⁷	CL69-248-4 ⁷	N/A	869-12	3226	N/A	7869-12	980-12	742-12	601-12	502-12
HIGH ENERGY™ Hydraulic Roller Turbo Camshafts											
K69-200-8	SK69-200-8 ⁷	CL69-200-8 ⁷	N/A	6853-12	3129	N/A	7966-12	26915-12 26918-12	787-12 1787-12	601-12 648-12	502-12 503-12 ²
K69-300-8	SK69-300-8 ⁷	CL69-300-8 ⁷	N/A	6853-12	3129	N/A	7966-12	26915-12 26918-12	787-12 1787-12	601-12 648-12	502-12 503-12 ²
K69-400-8	SK69-400-8 ⁷	CL69-400-8 ⁷	N/A	6853-12	3129	N/A	7966-12	26918-12	787-12 1787-12	601-12 648-12	502-12 503-12 ²

* K-Kit only includes cam, lifters, valve springs, timing set and seals.

BUICK 350 C.I. 8 CYL. 1968-1980

APPLICATIONS/CAMSHAFTS	VALVE SETTING		RPM OPERATING RANGE	CAM PART #	CAM GRIND #	DURATION				VALVE LIFT		LOBE SEP. ANGLE
	IN.	EX.				ADVERTISED IN.	EX.	@ .050" IN.	EX.	W/ 1.55 ROCKER IN.	EX.	
HIGH ENERGY™ Hydraulic Flat Tappet Camshafts												
HYDRAULIC – Excellent torque and mileage for family sedans. Good performance upgrade for stock camshaft. Smooth idle.	Hyd.	Hyd.	800 to 4800	92-200-4	252H	252	252	206	206	.439	.439	110°
HYDRAULIC – Excellent mid-range torque. Great for towing. Works well w/ stock manifolds. Smooth idle.	Hyd.	Hyd.	1200 to 5200	92-202-4	260H	260	260	212	212	.454	.454	110°
HYDRAULIC – Good performance camshaft in daily driven vehicles. Slightly choppy idle. Likes headers and 3.40-3.70 gears.	Hyd.	Hyd.	1500 to 5500	92-203-4	268H	268	268	218	218	.469	.469	110°
THUMPR™ Hydraulic Flat Tappet Camshafts												
HYDRAULIC – Thumpr™ – High performance street, stock converter ok, best with 2000+ converter and gears. Choppy/thumping idle.	Hyd.	Hyd.	2000 to 5800	92-600-5	279TH7	279	297	227	241	.494	.480	107°
HYDRAULIC – Mutha' Thumpr™ – High performance street/strip, needs 9:1 compression, 2500+ stall, intake, gears and headers, rough idle.	Hyd.	Hyd.	2200 to 6100	92-601-5	287TH7	287	305	235	249	.506	.491	107°
HYDRAULIC – Big Mutha' Thumpr™ – Street/strip, needs 9.5:1 compression, 2800+ stall, intake, gears and headers, very rough idle.	Hyd.	Hyd.	2500 to 6400	92-602-5	295TH7	295	313	243	257	.517	.502	107°

BUICK NAILHEAD 364, 401, 425 C.I. 8 CYL. 1957-1966

APPLICATIONS/CAMSHAFTS	VALVE SETTING		RPM OPERATING RANGE	CAM PART #	CAM GRIND #	DURATION				VALVE LIFT		LOBE SEP. ANGLE
	IN.	EX.				ADVERTISED IN.	EX.	@ .050" IN.	EX.	W/ 1.5 ROCKER IN.	EX.	
CLASSIC THUMPR™ Hydraulic Flat Tappet Camshafts												
HYDRAULIC – Classic Thumpr™ – Performance street with strong torque, stock converter ok. Choppy/thumping idle.	Hyd.	Hyd.	1500-5000	91-600-5	279TH7	279	297	227	241	.478	.465	107°
HYDRAULIC – Classic Mutha' Thumpr™ – High performance street/strip, head modification recommended to raise RPM limit, 2200+ stall, rough idle.	Hyd.	Hyd.	1700-5500	91-601-5	287TH7	287	305	235	249	.490	.475	107°
HYDRAULIC – Classic Big Mutha' Thumpr™ – Street/strip, must have head modification, 2500+ stall, very rough idle.	Hyd.	Hyd.	2000-6000	91-602-5	295TH7	295	313	243	257	.501	.486	107°

BUICK 400, 430, 455 C.I. 8 CYL. 1967-1976

APPLICATIONS/CAMSHAFTS	VALVE SETTING		RPM OPERATING RANGE	CAM PART #	CAM GRIND #	DURATION				VALVE LIFT		LOBE SEP. ANGLE
	IN.	EX.				ADVERTISED IN.	EX.	@ .050" IN.	EX.	W/ 1.55 ROCKER IN.	EX.	
HIGH ENERGY™ Hydraulic Flat Tappet Camshafts												
HYDRAULIC – Good performance upgrade for stock camshaft. Great torque and mileage in 400 with stock gear ratio, smooth idle.	Hyd.	Hyd.	800 to 4600	96-200-4	252H	252	252	206	206	.439	.439	110°
HYDRAULIC – Best all-around cam. Great torque and power in mid-range. Smooth idle. Best cam for towing or highway use in 455c.i.	Hyd.	Hyd.	1000 to 5000	96-202-4	260H	260	260	212	212	.454	.454	110°
HYDRAULIC – High performance cam for everyday driving. Broad powerband. Slightly rough idle in 400, smooth to noticeable idle in 455.	Hyd.	Hyd.	1200 to 5200	96-203-4	268H	268	268	218	218	.469	.469	110°

² Requires machining on cylinder heads⁷ Stock springs cannot be used

BUICK 350 C.I. 8 CYL. 1968-1980

K-KIT	SK-KIT	CL-KIT	RP-KIT	LIFTERS	TIMING SET	ROCKER ARMS	PUSHRODS	VALVE SPRINGS	RETAINERS	VALVE LOCKS	VALVE SEALS
HIGH ENERGY™ Hydraulic Flat Tappet Camshafts											
K92-200-4	SK92-200-4	CL92-200-4	N/A	869-16	3215	N/A	7861-16	942-16	N/A	N/A	505-16 ²
K92-202-4	SK92-202-4 ⁷	CL92-202-4 ⁷	N/A	869-16	3215	N/A	7861-16	942-16	N/A	N/A	505-16 ²
K92-203-4	SK92-203-4 ⁷	CL92-203-4 ⁷	N/A	869-16	3215	N/A	7861-16	942-16	N/A	N/A	505-16 ²
THUMPR™ Hydraulic Flat Tappet Camshafts											
K92-600-5	N/A	CL92-600-5 ⁷	N/A	869-16	3215	N/A	7861-16	942-16 926-16	N/A	N/A	505-16 ²
K92-601-5	N/A	CL92-601-5 ⁷	N/A	869-16	3215	N/A	7861-16	942-16 926-16	N/A	N/A	505-16 ²
K92-602-5	N/A	CL92-602-5 ⁷	N/A	869-16	3215	N/A	7861-16	942-16 926-16	N/A	N/A	505-16 ²

BUICK NAILHEAD 364, 401, 425 C.I. 8 CYL. 1957-1966

K-KIT	SK-KIT	CL-KIT	LIFTERS	DIST. GEAR	TIMING SET	ROCKER ARMS	PUSHRODS	VALVE SPRINGS	RETAINERS	VALVE LOCKS	VALVE SEALS
CLASSIC THUMPR™ Hydraulic Flat Tappet Camshafts											
N/A	N/A	N/A	852-16	N/A	N/A	N/A	N/A	N/A	N/A	N/A	N/A
N/A	N/A	N/A	852-16	N/A	N/A	N/A	N/A	N/A	N/A	N/A	N/A
N/A	N/A	N/A	852-16	N/A	N/A	N/A	N/A	N/A	N/A	N/A	N/A

BUICK 400, 430, 455 C.I. 8 CYL. 1967-1976

K-KIT	SK-KIT	CL-KIT	RP-KIT	LIFTERS	TIMING SET	ROCKER ARMS	PUSHRODS	VALVE SPRINGS	RETAINERS	VALVE LOCKS	VALVE SEALS
HIGH ENERGY™ Hydraulic Flat Tappet Camshafts											
K96-200-4	SK96-200-4	CL96-200-4	N/A	869-16	3217	N/A	7896-16	910-16	N/A	N/A	505-16 ²
K96-202-4	SK96-202-4 ⁷	CL96-202-4 ⁷	N/A	869-16	3217	N/A	7896-16	910-16	N/A	N/A	505-16 ²
K96-203-4	SK96-203-4 ⁷	CL96-203-4 ⁷	N/A	869-16	3217	N/A	7896-16	910-16	N/A	N/A	505-16 ²

RED NUMBERS DENOTE PREMIUM OPTION

BUICK 400, 430, 455 C.I. 8 CYL. 1967-1976 (CONTINUED)

APPLICATIONS/CAMSHAFTS	VALVE SETTING		RPM OPERATING RANGE	CAM PART #	CAM GRIND #	DURATION				VALVE LIFT		LOBE SEP. ANGLE
	IN.	EX.				ADVERTISED IN.	EX.	@ .050" IN.	EX.	W/ 1.55 ROCKER IN.	EX.	
XTREME ENERGY™ Hydraulic Flat Tappet Camshafts												
HYDRAULIC – Good mid-range power. Needs headers and 2200 stall.	Hyd.	Hyd.	2000 to 6000	96-210-4	XE274H	274	286	230	236	.506	.506	110°
THUMPR™ Hydraulic Flat Tappet Camshafts												
HYDRAULIC – Thumpr™ – High performance street, stock converter ok, best with 2000+ converter and gears. Choppy/thumping idle.	Hyd.	Hyd.	2000-5800	96-600-5	279TH7	279	297	227	241	.494	.480	107°
HYDRAULIC – Mutha' Thumpr™ – High performance street/strip, needs 9:1 compression, 2500+ stall, intake, gears and headers, rough idle.	Hyd.	Hyd.	2200-6100	96-601-5	287TH7	287	305	235	249	.506	.491	107°
HYDRAULIC – Big Mutha' Thumpr™ – Street/strip, needs 9.5:1 compression, 2800+ stall, intake, gears and headers, very rough idle.	Hyd.	Hyd.	2500-6400	96-602-5	295TH7	295	313	243	257	.517	.502	107°

CADILLAC 425, 472, 500 C.I. 8 CYL. 1963-1979

APPLICATIONS/CAMSHAFTS	VALVE SETTING		RPM OPERATING RANGE	CAM PART #	CAM GRIND #	DURATION				VALVE LIFT		LOBE SEP. ANGLE
	IN.	EX.				ADVERTISED IN.	EX.	@ .050" IN.	EX.	W/ 1.73 ROCKER IN.	EX.	
HIGH ENERGY™ Hydraulic Flat Tappet Camshafts												
HYDRAULIC – Very strong torque, good mileage. Good performance upgrade for stock cam. Very smooth idle.	Hyd.	Hyd.	800 to 4800	94-300-5	252H	252	252	206	206	.465	.465	110°
HYDRAULIC – Strong torque through low and mid-range, smooth idle.	Hyd.	Hyd.	1000 to 5000	94-302-5	260H	260	260	212	212	.481	.481	110°
HYDRAULIC – Good everyday performance cam, broad power, slightly noticeable idle.	Hyd.	Hyd.	1200 to 5200	94-304-5	268H	268	268	218	218	.490	.490	110°
MAGNUM Hydraulic Flat Tappet Camshafts												
HYDRAULIC – Performance street, strong mid-range, best w/ upgraded exhaust & 2000+ stall. Choppy idle.	Hyd.	Hyd.	1500 to 5500	94-306-5	270H	270	270	224	224	.516	.516	110°
THUMPR™ Hydraulic Flat Tappet Camshafts												
HYDRAULIC – Thumpr™ – High performance street, stock converter ok, best with 2000+ converter and gears. Choppy/thumping idle.	Hyd.	Hyd.	2000 to 5800	94-600-5	279TH7	278	296	226	241	.503	.490	107°
HYDRAULIC – Mutha' Thumpr™ – High performance street/strip, needs 9:1 compression, 2500+ stall, intake, gears and headers, rough idle.	Hyd.	Hyd.	2200 to 6100	94-601-5	287TH7	286	304	234	249	.516	.500	107°
HYDRAULIC – Big Mutha' Thumpr™ – Street/strip, needs 9.5:1 compression, 2800+ stall, intake, gears and headers, very rough idle.	Hyd.	Hyd.	2500 to 6400	94-602-5	295TH7	294	312	242	257	.528	.512	107°
XTREME ENERGY™ Hydraulic Roller Camshafts												
HYDRAULIC ROLLER - Perfect all around performance grind for heavy vehicles w/o major mods. Almost stock idle, but noticeable in lower compression engines.	Hyd.	Hyd.	1200-4800	94-800-10	XE270HR-10	270	276	218	224	.555	.555	110°
HYDRAULIC ROLLER - Best all around high performance hyd roller camshaft for modified 500 c.i. engines with high compression, converter and gears.	Hyd.	Hyd.	1800-5400	94-801-10	XE285HR-10	285	291	230	236	.558	.558	110°

² Requires machining on cylinder heads

⁷ Stock springs cannot be used

BUICK 400, 430, 455 C.I. 8 CYL. 1967-1976 (CONTINUED)

K-KIT	SK-KIT	CL-KIT	RP-KIT	LIFTERS	TIMING SET	ROCKER ARMS	PUSHRODS	VALVE SPRINGS	RETAINERS	VALVE LOCKS	VALVE SEALS
XTREME ENERGY™ Hydraulic Flat Tappet Camshafts											
N/A	N/A	N/A	N/A	869-16	3217	N/A	7896-16	26120-16 ²	N/A	N/A	505-16 ²
THUMPR™ Hydraulic Flat Tappet Camshafts											
K96-600-5	N/A	CL96-600-5 ⁷	N/A	869-16	3217	N/A	7896-16	910-16 26120-16 ²	N/A	N/A	505-16 ²
K96-601-5	N/A	CL96-601-5 ⁷	N/A	869-16	3217	N/A	7896-16	26120-16 ²	N/A	N/A	505-16 ²
K96-602-5	N/A	CL96-602-5 ⁷	N/A	869-16	3217	N/A	7896-16	26120-16 ²	N/A	N/A	505-16 ²

CADILLAC 425, 472, 500 C.I. 8 CYL. 1963-1979

K-KIT	SK-KIT	CL-KIT	RP-KIT	LIFTERS	TIMING SET	ROCKER ARMS	PUSHRODS	VALVE SPRINGS	RETAINERS	VALVE LOCKS	VALVE SEALS
HIGH ENERGY™ Hydraulic Flat Tappet Camshafts											
N/A	N/A	CL94-300-5 ⁷	N/A	869-16	N/A	N/A	N/A	981-16 ² 26981-16 ²	742-16 787-16	601-16	503-16 ²
N/A	N/A	CL94-302-5 ⁷	N/A	869-16	N/A	N/A	N/A	981-16 ² 26981-16 ²	742-16 787-16	601-16	503-16 ²
N/A	N/A	CL94-304-5 ⁷	N/A	869-16	N/A	N/A	N/A	981-16 ² 26981-16 ²	742-16 787-16	601-16	503-16 ²
MAGNUM Hydraulic Flat Tappet Camshafts											
N/A	N/A	CL94-306-5 ⁷	N/A	869-16	N/A	N/A	N/A	986-16 ² 26986-16 ²	740-16 795-16	611-16 614-16	503-16 ²
THUMPR™ Hydraulic Flat Tappet Camshafts											
N/A	N/A	CL94-600-5 ⁷	N/A	869-16	2139	N/A	N/A	986-16 ² 26986-16 ²	740-16 795-16	611-16 614-16	503-16 ²
N/A	N/A	CL94-601-5 ⁷	N/A	869-16	2139	N/A	N/A	986-16 ² 26986-16 ²	740-16 795-16	611-16 614-16	503-16 ²
N/A	N/A	CL94-602-5 ⁷	N/A	869-16	2139	N/A	N/A	986-16 ² 26986-16 ²	740-16 795-16	611-16 614-16	503-16 ²
XTREME ENERGY™ Hydraulic Roller Camshafts											
N/A	SK94-800-10	CL-94-800-10	N/A	8962-16	2139	N/A	N/A	26918-16	795-16	613-16	503-16
N/A	SK94-801-10	CL94-801-10	N/A	8962-16	2139	N/A	N/A	26918-16	795-16	613-16	503-16

RED NUMBERS DENOTE PREMIUM OPTION



CADILLAC 425, 472, 500 C.I. 8 CYL. 1963-1979 (CONTINUED)

APPLICATIONS/CAMSHAFTS	VALVE SETTING		RPM OPERATING RANGE	CAM PART #	CAM GRIND #	DURATION				VALVE LIFT		LOBE SEP. ANGLE
	IN. EX.					ADVERTISED		@ .050"		W/ 1.75 ROCKER		
	IN.	EX.				IN.	EX.	IN.	EX.	IN.	EX.	
THUMPR™ Hydraulic Roller Camshafts												
HYDRAULIC ROLLER – Thumpr™ – High performance street, stock converter ok, best with 2000+ converter and gears. Choppy/thumping idle.	Hyd.	Hyd.	2000-5400	94-600-10	283THR7	283	303	227	241	.555	.538	107°
HYDRAULIC ROLLER – Mutha' Thumpr™ – High performance street/strip, needs 9:1 compression, 2500+ stall, intake, gears and headers, rough idle.	Hyd.	Hyd.	2200-5600	94-601-10	291THR7	291	311	235	249	.566	.550	107°
HYDRAULIC ROLLER – Big Mutha' Thumpr™ – Street/strip, needs 9.5:1 compression, 2800+ stall, intake, gears and headers, very rough idle.	Hyd.	Hyd.	2500-5800	94-602-10	299THR7	299	319	243	257	.578	.562	107°

CHEVROLET 153 C.I. CHEVY II 4 CYL. 1962-1970

APPLICATIONS/CAMSHAFTS	VALVE SETTING		RPM OPERATING RANGE	CAM PART #	CAM GRIND #	DURATION				VALVE LIFT		LOBE SEP. ANGLE
	IN. EX.					ADVERTISED		@ .050"		W/ 1.75 ROCKER		
	IN.	EX.				IN.	EX.	IN.	EX.	IN.	EX.	
HIGH ENERGY™ Hydraulic Flat Tappet Camshafts												
HYDRAULIC – Good torque and power with smooth idle. Strong increase over stock.	Hyd.	Hyd.	800 to 4800	14-119-4	252H	252	252	206	206	.460	.460	110°
HYDRAULIC – Good combination of torque and power. Performance street and marine.	Hyd.	Hyd.	1200 to 5200	14-123-4	260H	260	260	212	212	.475	.475	110°

GM ECOTEC 2.2L 4 CYL.

APPLICATIONS/CAMSHAFTS	VALVE SETTING		RPM OPERATING RANGE	CAM PART #	CAM GRIND #	DURATION				VALVE LIFT		LOBE SEP. ANGLE
	IN. EX.					ADVERTISED		@ .050"		W/ 1.75 ROCKER		
	IN.	EX.				IN.	EX.	IN.	EX.	IN.	EX.	
XTREME ENERGY™ Hydraulic Roller Cast Core Camshafts												
HYDRAULIC ROLLER – Turbo applications, wide power range, good power with few modifications.	Hyd.	Hyd.	2200 to 7000	113150	XE246THR-13	248	244	204	200	.423	.419	113°
HYDRAULIC ROLLER – Street applications, wide power range, strong torque, works best with programmer or computer modifications.	Hyd.	Hyd.	2600 to 6800	113200	XE252HR-11	252	256	210	212	.423	.419	111°
HYDRAULIC ROLLER – Blower applications, excellent for performance street applications w/ programmers.	Hyd.	Hyd.	2800 to 7000	113250 113260*	XE252BHR-13	252	262	210	218	.423	.436	113°
HYDRAULIC ROLLER – Street/strip applications, requires programmer or computer modifications.	Hyd.	Hyd.	3000 to 7500	113300 113350*	XE258HR-11	258	262	216	218	.440	.436	111°
HYDRAULIC ROLLER – Street/strip high RPM applications, requires computer modifications, very strong power over 5000 RPM.	Hyd.	Hyd.	3500 to 8000	113400 113450*	XE264HR-13	264	268	222	224	.456	.453	113°

NOTE: 2.0L available upon request

*Steel Core Version

² Requires machining on cylinder heads

⁷ Stock springs cannot be used

CADILLAC 425, 472, 500 C.I. 8 CYL. 1963-1979 (CONTINUED)

K-KIT	SK-KIT	CL-KIT	RP-KIT	LIFTERS	TIMING SET	ROCKER ARMS	PUSHRODS	VALVE SPRINGS	RETAINERS	VALVE LOCKS	VALVE SEALS	
XTREME ENERGY™ Hydraulic Roller Camshafts												
N/A	SK94-600-10	CL94-600-10	N/A	8962-16	2139	N/A	N/A	26918-16	795-16	613-16	503-16	
N/A	SK94-601-10	CL94-601-10	N/A	8962-16	2139	N/A	N/A	26918-16	795-16	613-16	503-16	
N/A	SK94-602-10	CL94-602-10	N/A	8962-16	2139	N/A	N/A	26918-16	795-16	613-16	503-16	

CHEVROLET 153 C.I. CHEVY II 4 CYL. 1962-1970

K-KIT	SK-KIT	CL-KIT	RP-KIT	LIFTERS	TIMING SET	ROCKER ARMS	PUSHRODS	VALVE SPRINGS	RETAINERS	VALVE LOCKS	VALVE SEALS	
HIGH ENERGY™ Hydraulic Flat Tappet Camshafts												
K14-119-4	SK14-119-4 ⁷	CL14-119-4 ⁷	N/A	812-8	3211	1261-8	7861-8	981-8 ² 26981-8 ²	742-8 787-8	601-8	501-8	
K14-123-4	SK14-123-4 ⁷	CL14-123-4 ⁷	N/A	812-8	3211	1261-8	7861-8	981-8 ² 26981-8 ²	742-8 787-8	601-8	501-8	

GM ECOTEC 2.2L 4 CYL.

K-KIT	SK-KIT	CL-KIT	RP-KIT	LIFTERS	TIMING SET	ROCKER ARMS	PUSHRODS	VALVE SPRINGS	RETAINERS	VALVE LOCKS	VALVE SEALS	
XTREME ENERGY™ Hydraulic Roller Cast Core Camshafts												
N/A	N/A	N/A	N/A	N/A	N/A	N/A	N/A	N/A	N/A	N/A	N/A	
N/A	N/A	N/A	N/A	N/A	N/A	N/A	N/A	N/A	N/A	N/A	N/A	
N/A	N/A	N/A	N/A	N/A	N/A	N/A	N/A	N/A	N/A	N/A	N/A	
N/A	N/A	N/A	N/A	N/A	N/A	N/A	N/A	N/A	N/A	N/A	N/A	
N/A	N/A	N/A	N/A	N/A	N/A	N/A	N/A	N/A	N/A	N/A	N/A	

CAMSHAFTS GENERAL MOTORS

CHEVROLET 173-207 C.I. (2.8L-3.4L) 60° 6 CYL. 1979-1994

APPLICATIONS/CAMSHAFTS	VALVE SETTING		RPM OPERATING RANGE	CAM PART #	CAM GRIND #	DURATION				VALVE LIFT		LOBE SEP. ANGLE
	IN.	EX.				ADVERTISED IN.	EX.	@ .050"		W/ 1.5 ROCKER IN.	EX.	
								IN.	EX.			
HIGH ENERGY™ Hydraulic Flat Tappet Camshafts												
HYDRAULIC – Works with stock computer and fuel injection. Good performance upgrade for stock cam.	Hyd.	Hyd.	500 to 4500	16-115-4	240H	240	248	192	200	.390	.390	108°
HYDRAULIC – Good power for 2 or 4 wheel drive S-10, S-15 or Blazer. Works well in mild towing applications. Smooth idle.	Hyd.	Hyd.	800 to 4800	16-232-4	252H	252	252	206	206	.425	.425	110°
HYDRAULIC – Good performance cam for 2.8L engine. Lope at idle w/ extremely good top end power.	Hyd.	Hyd.	1000 to 5000	16-233-4	260H	260	260	212	212	.440	.440	110°

CHEVROLET 194-250 C.I. 6 CYL. 1963-1984

APPLICATIONS/CAMSHAFTS	VALVE SETTING		RPM OPERATING RANGE	CAM PART #	CAM GRIND #	DURATION				VALVE LIFT		LOBE SEP. ANGLE
	IN.	EX.				ADVERTISED IN.	EX.	@ .050"		W/ 1.75 ROCKER IN.	EX.	
								IN.	EX.			
HIGH ENERGY™ Hydraulic Flat Tappet Camshafts												
HYDRAULIC – Good performance upgrade for stock cam. Excellent torque & mileage. Very smooth idle.	Hyd.	Hyd.	500 to 4500	61-113-4	240H	240	248	192	200	.455	.455	108°
HYDRAULIC – Good city & highway driving, strong vacuum. Works w/ stock computer. Good torque & mileage.	Hyd.	Hyd.	800 to 4800	61-232-4	252H	252	252	206	206	.474	.474	110°
HYDRAULIC – Best for towing, off-road and 4WD trucks. Noticeable idle. Good for highway driving.	Hyd.	Hyd.	1000 to 5000	61-233-4	260H	260	260	212	212	.489	.489	110°

MAGNUM Hydraulic Flat Tappet Camshafts

HYDRAULIC – Good street performance with stock converter or 2000+ stall, choppy idle.	Hyd.	Hyd.	1200 to 5200	61-244-4	268H	268	268	218	218	.499	.499	110°
HYDRAULIC – Great for street machines. Needs 2500+ stall, headers and gears. Rough idle.	Hyd.	Hyd.	1500 to 5500	61-246-4	280H	280	280	230	230	.536	.536	110°

APPLICATIONS/CAMSHAFTS	VALVE SETTING		RPM OPERATING RANGE	CAM PART #	CAM GRIND #	DURATION				VALVE LIFT		LOBE SEP. ANGLE
	IN.	EX.				ADVERTISED IN.	EX.	@ .050"		W/ 1.75 ROCKER IN.	EX.	
								IN.	EX.			
HI-TECH™ Mechanical Flat Tappet Camshafts												
SOLID – Good for mini-stock with stock engine, when solid lifters can be used.	.022	.024	1500 to 5500	61-238-5	264S-8	264	264	220	220	.513	.513	108°
SOLID – Good for 1/8 mile drag or 1/4 to 3/8 mile oval track. Broad torque range.	.022	.024	3500 to 6500	61-662-5	280B-6	280	284	242	246	.591	.570	106°
SOLID – For 1/4 mile drag or 3/8 to 5/8 mile oval track. Needs good cylinder heads, carb and intake.	.022	.024	4000 to 7000	61-664-5	294A-8	294	294	256	256	.596	.596	108°

CHEVROLET 200-229 C.I. (3.8L) 90° 6 CYL. 1978-1984

APPLICATIONS/CAMSHAFTS	VALVE SETTING		RPM OPERATING RANGE	CAM PART #	CAM GRIND #	DURATION				VALVE LIFT		LOBE SEP. ANGLE
	IN.	EX.				ADVERTISED IN.	EX.	@ .050"		W/ 1.5 ROCKER IN.	EX.	
								IN.	EX.			
HIGH ENERGY™ Hydraulic Flat Tappet Camshafts												
HYDRAULIC – Great torque, good mileage. Works well w/ high gear ratios & overdrive transmissions. Good city driving.	Hyd.	Hyd.	500 to 4500	15-115-4	240H	240	248	192	200	.390	.390	108°
HYDRAULIC – Strong torque, good for trucks, 4WD & mild towing. Works w/ stock computer. Smooth idle & good mileage.	Hyd.	Hyd.	800 to 4800	15-200-4	252H	252	252	206	206	.425	.425	110°
HYDRAULIC – Good cam for highway use, off-road and towing. Good for trucks with low gear ratios.	Hyd.	Hyd.	1000 to 5000	15-201-4	260H	260	260	212	212	.440	.440	110°

¹ Requires screw-in studs & guide plates

² Requires machining on cylinder heads

⁷ Stock springs cannot be used

CHEVROLET 173-207 C.I. (2.8L-3.4L) 60° 6 CYL. 1979-1994

K-KIT	SK-KIT	CL-KIT	RP-KIT	LIFTERS	TIMING SET	ROCKER ARMS	PUSHRODS	VALVE SPRINGS	RETAINERS	VALVE LOCKS	VALVE SEALS
HIGH ENERGY™ Hydraulic Flat Tappet Camshafts											
K16-115-4	SK16-115-4	CL16-115-4	RP1413-12	802-12	3201	1413-12	7816-12	980-12	742-12	601-12	501-12
K16-232-4	SK16-232-4	CL16-232-4	RP1413-12	802-12	3201	1413-12	7816-12	980-12	742-12	601-12	501-12
K16-233-4	SK16-233-4 ⁷	CL16-233-4 ⁷	RP1413-12	802-12	3201	1413-12	7816-12	980-12	742-12	601-12	501-12

CHEVROLET 194-250 C.I. 6 CYL. 1963-1984

K-KIT	SK-KIT	CL-KIT	RP-KIT	LIFTERS	TIMING SET	ROCKER ARMS	PUSHRODS	VALVE SPRINGS	RETAINERS	VALVE LOCKS	VALVE SEALS
HIGH ENERGY™ Hydraulic Flat Tappet Camshafts											
K61-113-4	SK61-113-4	CL61-113-4	N/A	812-12	3211	1261-12	7861-12	981-12 26981-12	742-12 787-12	601-12	501-12
K61-232-4	SK61-232-4 ⁷	CL61-232-4 ⁷	N/A	812-12	3211	1261-12	7861-12	981-12 26981-12	742-12 787-12	601-12	501-12
K61-233-4	SK61-233-4 ⁷	CL61-233-4 ⁷	N/A	812-12	3211	1261-12	7861-12	981-12 26981-12	742-12 787-12	601-12	501-12

MAGNUM Hydraulic Flat Tappet Camshafts

K61-244-4	SK61-244-4 ⁷	CL61-244-4 ⁷	N/A	812-12 858-12	3211	1261-12	7861-12	986-12 ² 26986-12 ²	740-12 795-12	611-12 614-12	503-12 ²
K61-246-4	SK61-246-4 ⁷	CL61-246-4 ⁷	N/A	812-12 858-12	3211	1261-12	7861-12	986-12 ² 26986-12 ²	740-12 795-12	611-12 614-12	503-12 ²

K-KIT	SK-KIT	CL-KIT	RP-KIT	LIFTERS	TIMING SET	ROCKER ARMS	PUSHRODS	VALVE SPRINGS	RETAINERS	VALVE LOCKS	VALVE SEALS
HI-TECH™ Mechanical Flat Tappet Camshafts											
N/A	N/A	N/A	N/A	813-12	3161	1261-12 ¹	7861-12	986-12 ² 26986-12 ²	740-12 795-12	611-12 614-12	503-12 ²
N/A	N/A	N/A	N/A	813-12	3161	1261-12 ¹	7861-12	987-12 ² 26918-12 ²	740-12 795-12	611-12 614-12	503-12 ²
N/A	N/A	N/A	N/A	813-12	3161	1261-12 ¹	7861-12	987-12 ² 26918-12 ²	740-12 795-12	611-12 614-12	503-12 ²

CHEVROLET 200-229 C.I. (3.8L) 90° 6 CYL. 1978-1984

K-KIT	SK-KIT	CL-KIT	RP-KIT	LIFTERS	TIMING SET	ROCKER ARMS	PUSHRODS	VALVE SPRINGS	RETAINERS	VALVE LOCKS	VALVE SEALS
HIGH ENERGY™ Hydraulic Flat Tappet Camshafts											
K15-115-4	SK15-115-4	CL15-115-4	RP1412-12	812-12	3200	1412-12 ⁹	7812-12	980-12	742-12	601-12	501-12
K15-200-4	SK15-200-4	CL15-200-4	RP1412-12	812-12	3200	1412-12 ⁹	7812-12	980-12	742-12	601-12	501-12
K15-201-4	SK15-201-4	CL15-201-4	RP1412-12	812-12	3200	1412-12 ⁹	7812-12	980-12	742-12	601-12	501-12

⁹ 50-State legal for 1993 & earlier Chevrolet V6 200-229c.i. C.A.R.B. E.O. #D-279-4

RED NUMBERS DENOTE PREMIUM OPTION



GM 3800/3.8 6 CYL. 1996-PRESENT

APPLICATIONS/CAMSHAFTS	VALVE SETTING		RPM OPERATING RANGE	CAM PART #	CAM GRIND #	DURATION				VALVE LIFT		LOBE SEP. ANGLE
	IN.	EX.				ADVERTISED		@ .050"		W/ 1.6 ROCKER		
						IN.	EX.	IN.	EX.	IN.	EX.	
XTREME ENERGY™ Hydraulic Roller Camshafts												
HYDRAULIC ROLLER – Performance upgrade for stock cam. Naturally aspirated, daily usage. Significant improvement over stock. Must replace springs.	Hyd.	Hyd.	800 to 4800	76-800-9⁷	246 HR10	246	256	191	201	.480	.496	110°
HYDRAULIC ROLLER – Naturally aspirated performance cam. Best w/ intake improvements. Must replace springs.	Hyd.	Hyd.	1000 to 5500	76-801-9⁷	255 HR12	255	262	201	205	.496	.480	112°
HYDRAULIC ROLLER – Blower performance cam. Best with pulley change for increased boost. Must replace springs.	Hyd.	Hyd.	1000 to 5500	76-802-9⁷	264 HR15	264	274	210	220	.512	.512	115°

CHEVROLET 4.3L 262 C.I. 90° 6 CYL. 1980-1997

APPLICATIONS/CAMSHAFTS	VALVE SETTING		RPM OPERATING RANGE	CAM PART #	CAM GRIND #	DURATION				VALVE LIFT		LOBE SEP. ANGLE
	IN.	EX.				ADVERTISED		@ .050"		W/ 1.5 ROCKER		
						IN.	EX.	IN.	EX.	IN.	EX.	
XTREME ENERGY™ Hydraulic Flat Tappet Camshafts												
HYDRAULIC – Excellent torque/good mileage. Works well with high gear ratios and overdrive transmissions. Good city driving.	Hyd.	Hyd.	500 to 4500	18-115-4³⁷	240H	240	248	192	200	.390	.390	108°
HYDRAULIC – Good power for trucks, 4WD and mild towing. Works well with stock computer. Smooth idle and good economy.	Hyd.	Hyd.	800 to 4800	18-119-4³⁷	252H	252	252	206	206	.425	.425	110°
HYDRAULIC – Good cam for highway use, off-road and towing. Good for trucks with low gear ratios.	Hyd.	Hyd.	1000 to 5000	18-123-4³⁷	260H	260	260	212	212	.444	.444	110°
HYDRAULIC – High performance, non-computer, low gears, 2000+ stall suggested.	Hyd.	Hyd.	1000 to 5000	18-124-4³⁷	268H	268	268	218	218	.454	.454	110°

MAGNUM Retro-Fit Hydraulic Roller Camshafts

(For Non-Computer Controlled)

HYDRAULIC ROLLER – Performance upgrade for stock camshaft. Good mileage, smooth idle. Vans, pickups & towing. Stock gear ratios & torque converter.	Hyd.	Hyd.	1200 to 4500	18-410-8^{10,37}	260HR	260	260	206	206	.500	.500	110°
HYDRAULIC ROLLER – Mild street performance, slightly noticeable lobe at idle. Stock converter, aftermarket intake and headers. 3.40-4.10 gears.	Hyd.	Hyd.	1800 to 5000	18-420-8^{10,37}	270HR	270	270	215	215	.500	.500	110°
HYDRAULIC ROLLER – Limited high performance street use. Aftermarket intake, headers and 2500+ stall, 3.40-4.10 gears. Mild rough idle.	Hyd.	Hyd.	2000 to 5500	18-430-8^{10,37}	280HR	280	280	224	224	.525	.525	110°

MAGNUM Computer Controlled Retro-Fit Hydraulic Roller Camshafts

HYDRAULIC ROLLER – Works with stock computer, fuel injection. Good low end torque and gas mileage.	Hyd.	Hyd.	1200 to 4500	18-412-8^{10,37}	260AHR	260	266	206	210	.500	.500	112°
HYDRAULIC ROLLER – Works with throttle body and sequential port injection with aftermarket chip. Good low end, mid-range.	Hyd.	Hyd.	1800 to 5000	18-415-8^{10,37}	266HR	266	270	210	215	.500	.500	112°
HYDRAULIC ROLLER – Performance cam for computer cars. Needs aftermarket chip and exhaust. Strong mid-range and top end.	Hyd.	Hyd.	2000 to 5500	18-422-8^{10,37}	270AHR	270	276	215	220	.500	.510	114°

² Requires machining on cylinder heads
⁷ Stock springs cannot be used

⁹ 50-State legal for 1993 & earlier Chevrolet V6 200-229c.i. C.A.R.B. E.O. #D-279-4

¹⁰ Requires thrust button & wear plate

GM 3800/3.8 6 CYL. 1996-PRESENT

LIFTERS	TIMING SET	ROCKER ARMS	PUSHRODS	VALVE SPRINGS	RETAINERS	VALVE LOCKS	VALVE SEALS	LASH CAPS	REV KIT	DIST. GEAR	STUD GIRDLES	
XTREME ENERGY™ Hydraulic Roller Camshafts												
850-12 ¹¹ 875-12 ¹¹	N/A	N/A	7937-12	26915-12 26918-12	774-12 772-12	623-12	511-12 ²	N/A	N/A	N/A	N/A	
850-12 ¹¹ 875-12 ¹¹	N/A	N/A	7937-12	26915-12 26918-12	774-12 772-12	623-12	511-12 ²	N/A	N/A	N/A	N/A	
850-12 ¹¹ 875-12 ¹¹	N/A	N/A	7937-12	26915-12 26918-12	774-12 772-12	623-12	511-12 ²	N/A	N/A	N/A	N/A	

CHEVROLET 4.3L 262 C.I. 90° 6 CYL. 1980-1997

K-KIT	SK-KIT	CL-KIT	RP-KIT	LIFTERS	TIMING SET	ROCKER ARMS	PUSHRODS	VALVE SPRINGS	RETAINERS	VALVE LOCKS	VALVE SEALS
XTREME ENERGY™ Flat Tappet Camshafts											
K18-115-4	SK18-115-4	CL18-115-4	RP1412-12	812-12	3200	1412-12 ⁹	7812-12	980-12	742-12	601-12	501-12
K18-119-4	SK18-119-4	CL18-119-4	RP1412-12	812-12	3200	1412-12 ⁹	7812-12	980-12	742-12	601-12	501-12
K18-123-4	SK18-123-4	CL18-123-4	RP1412-12	812-12	3200	1412-12 ⁹	7812-12	980-12	742-12	601-12	501-12
K18-124-4	SK18-124-4 ⁷	CL18-124-4 ⁷	RP1412-12	812-12	3200	1412-12 ⁹	7812-12	981-12 26981-12	742-12 787-12	601-12	501-12

MAGNUM Retro-Fit Hydraulic Roller Camshafts

K18-410-8	SK18-410-8 ^{7,10}	CL18-410-8 ^{7,10}	RPR200-12	853-12 15853-12	2100 3100	1412-12 ⁹ 1601-12 ⁹	7809-12 7949-12	986-12 ² 26986-12 ²	740-12 795-12	611-12 614-12	503-12 ²
K18-420-8	SK18-420-8 ^{7,10}	CL18-420-8 ^{7,10}	RPR200-12	853-12 15853-12	2100 3100	1412-12 ⁹ 1601-12 ⁹	7809-12 7949-12	986-12 ² 26986-12 ²	740-12 795-12	611-12 614-12	503-12 ²
K18-430-8	SK18-430-8 ^{7,10}	CL18-430-8 ^{7,10}	RPR200-12	853-12 15853-12	2100 3100	1412-12 ⁹ 1601-12 ⁹	7809-12 7949-12	986-12 ² 26986-12 ²	740-12 795-12	611-12 614-12	503-12 ²

MAGNUM Computer Controlled Retro-Fit Hydraulic Roller Camshafts

K 18-412-8	SK18-412-8 ^{7,10}	CL 18-412-8 ^{7,10}	RPR200-12	853-12 15853-12	2100 3100	1412-12 ⁹ 1601-12 ⁹	7809-12 7949-12	986-12 ² 26986-12 ²	740-12 795-12	611-12 614-12	503-12 ²
K18-415-8	SK18-415-8 ^{7,10}	CL18-415-8 ^{7,10}	RPR200-12	853-12 15853-12	2100 3100	1412-12 ⁹ 1601-12 ⁹	7809-12 7949-12	986-12 ² 26986-12 ²	740-12 795-12	611-12 614-12	503-12 ²
K18-422-8	SK18-422-8 ^{7,10}	CL18-422-8 ^{7,10}	RPR200-12	853-12 15853-12	2100 3100	1412-12 ⁹ 1601-12 ⁹	7809-12 7949-12	986-12 ² 26986-12 ²	740-12 795-12	611-12 614-12	503-12 ²

¹¹ Lifters only, does not include lifter retainers or guides

⁹⁷ Adjustable valve train required

CHEVROLET 4.3L 262 C.I. 90° 6 CYL. 1980-1997 (CONTINUED)

APPLICATIONS/CAMSHAFTS	VALVE SETTING		RPM OPERATING RANGE	CAM PART #	CAM GRIND #	DURATION				VALVE LIFT		LOBE SEP. ANGLE
	IN.	EX.				ADVERTISED IN.	EX.	@ .050" IN.	EX.	W/ 1.5 ROCKER IN.	EX.	
MAGNUM Hydraulic Roller Camshafts (NON-BALANCE SHAFT)												
1987-Present Engines												
HYDRAULIC ROLLER – Performance upgrade for stock camshaft. Good mileage, smooth idle. Works with vans, pickups & towing. Stock gear ratios & converter.	Hyd.	Hyd.	1200 to 4500	09-410-8³⁷	260HR	260	260	206	206	.500	.500	110°
HYDRAULIC ROLLER – Mild street performance. Slight lobe at idle. Stock converter, aftermarket intake and headers. 3.40 to 4.10 gears.	Hyd.	Hyd.	1800 to 5000	09-420-8³⁷	270HR	270	270	215	215	.500	.500	110°
HYDRAULIC ROLLER – Limited high performance street use. Needs intake, headers and 2500+ stall, 3.73 to 4.10 gears. Mild rough idle.	Hyd.	Hyd.	2000 to 5500	09-430-8³⁷	280HR	280	280	224	224	.525	.525	110°
MAGNUM Computer Controlled Hydraulic Roller Camshafts (NON-BALANCE SHAFT)												
1987-Present Engines												
HYDRAULIC ROLLER – Works w/ stock computer & fuel injection. Low lift for non-modified cylinder heads.	Hyd.	Hyd.	1000 to 4300	09-435-8	251HR	251	257	200	206	.428	.459	114°
HYDRAULIC ROLLER – Works with stock computer and fuel injection. Good low end torque and mileage.	Hyd.	Hyd.	1200 to 4500	09-412-8³⁷	260AHR	260	266	206	210	.500	.500	112°
HYDRAULIC ROLLER – Works with throttle body and sequential port injection with aftermarket chip. Good low end and mid-range.	Hyd.	Hyd.	1800 to 5000	09-415-8³⁷	266HR	266	270	210	215	.500	.500	112°
HYDRAULIC ROLLER – Performance cam for computer cars. Needs aftermarket chip, exhaust and mild stall. Strong mid-range and top end.	Hyd.	Hyd.	2000 to 5500	09-422-8³⁷	270AHR	270	276	215	220	.500	.510	114°

CHEVROLET 4.3L 262 C.I. 90° WITH BALANCE SHAFT 6 CYL. 1992-PRESENT

APPLICATIONS/CAMSHAFTS	VALVE SETTING		RPM OPERATING RANGE	CAM PART #	CAM GRIND #	DURATION				VALVE LIFT		LOBE SEP. ANGLE
	IN.	EX.				ADVERTISED IN.	EX.	@ .050" IN.	EX.	W/ 1.5 ROCKER IN.	EX.	
MAGNUM Hydraulic Roller Camshafts (W/ BALANCE SHAFT)												
HYDRAULIC ROLLER – Great torque for trucks, 4WD and light towing. Has smooth idle. Works with stock components, small carburetor.	Hyd.	Hyd.	1200 to 4500	56-410-8³⁷	260HR	260	260	206	206	.500	.500	110°
HYDRAULIC ROLLER – Mild street performance with slight idle for stock converters with aftermarket intake and headers.	Hyd.	Hyd.	1800 to 5000	56-420-8³⁷	270HR	270	270	215	215	.500	.500	110°
HYDRAULIC ROLLER – Limited high performance with rough idle. Needs intake, headers and 2500+ stall with 3.73 to 4.10 gears.	Hyd.	Hyd.	2000 to 5500	56-430-8³⁷	280HR	280	280	224	224	.525	.525	110°
MAGNUM Computer Controlled Hydraulic Roller Camshafts (W/ BALANCE SHAFT)												
HYDRAULIC ROLLER – Works with stock computer and fuel injection. Good low end torque and mileage.	Hyd.	Hyd.	1200 to 4500	56-440-8³⁷	260AHR	260	266	206	210	.500	.500	112°
HYDRAULIC ROLLER – Works with throttle body and sequential port injection with aftermarket chip. Good low end and mid-range.	Hyd.	Hyd.	1800 to 5000	56-450-8³⁷	266HR	266	270	210	215	.500	.500	112°
HYDRAULIC ROLLER – Performance cam for computer cars. Needs aftermarket chip and exhaust. Strong mid-range and top end.	Hyd.	Hyd.	2000 to 5500	56-460-8³⁷	270AHR	270	276	215	220	.500	.510	114°

² Requires machining on cylinder heads

⁷ Stock springs cannot be used

⁹ 50-State legal for 1993 & earlier Chevrolet V6 200-229c.i. C.A.R.B. E.O. #D-279-4

CHEVROLET 4.3L 262 C.I. 90° 6 CYL. 1980-1997 (CONTINUED)

K-KIT	SK-KIT	CL-KIT	RP-KIT	LIFTERS	TIMING SET	ROCKER ARMS	PUSHRODS	VALVE SPRINGS	RETAINERS	VALVE LOCKS	VALVE SEALS
MAGNUM Hydraulic Roller Camshafts (NON-BALANCE SHAFT)											
K09-410-8	SK09-410-8 ⁷	CL09-410-8 ⁷	RPH300-12	850-12 ¹¹ 875-12 ¹¹	3136	1417-12 ⁹ 1617-12 ⁹	7808-12 7940-12	986-12 ² 26986-12 ²	740-12 795-12	611-12 614-12	503-12 ²
K09-420-8	SK09-420-8 ⁷	CL09-420-8 ⁷	RPH300-12	850-12 ¹¹ 875-12 ¹¹	3136	1417-12 ⁹ 1617-12 ⁹	7808-12 7940-12	986-12 ² 26986-12 ²	740-12 795-12	611-12 614-12	503-12 ²
K09-430-8	SK09-430-8 ⁷	CL09-430-8 ⁷	RPH300-12	850-12 ¹¹ 875-12 ¹¹	3136	1417-12 ⁹ 1617-12 ⁹	7808-12 7940-12	986-12 ² 26986-12 ²	740-12 795-12	611-12 614-12	503-12 ²
MAGNUM Computer Controlled Hydraulic Roller Camshafts (NON-BALANCE SHAFT)											
K09-435-8	SK09-435-8	CL09-435-8	RPH300-12	850-12 ¹¹ 875-12 ¹¹	3136	1417-12 ⁹ 1617-12 ⁹	7808-12 7940-12	986-12 ² 26986-12 ²	740-12 795-12	611-12 614-12	501-12
K09-412-8	SK09-412-8 ⁷	CL09-412-8 ⁷	RPH300-12	850-12 ¹¹ 875-12 ¹¹	3136	1417-12 ⁹ 1617-12 ⁹	7808-12 7940-12	986-12 ² 26986-12 ²	740-12 795-12	611-12 614-12	503-12 ²
K09-415-8	SK09-415-8 ⁷	CL09-415-8 ⁷	RPH300-12	850-12 ¹¹ 875-12 ¹¹	3136	1417-12 ⁹ 1617-12 ⁹	7808-12 7940-12	986-12 ² 26986-12 ²	740-12 795-12	611-12 614-12	503-12 ²
K09-422-8	SK09-422-8 ⁷	CL09-422-8 ⁷	RPH300-12	850-12 ¹¹ 875-12 ¹¹	3136	1417-12 ⁹ 1617-12 ⁹	7808-12 7940-12	986-12 ² 26986-12 ²	740-12 795-12	611-12 614-12	503-12 ²

CHEVROLET 4.3L 262 C.I. 90° WITH BALANCE SHAFT 6 CYL. 1992-PRESENT

K-KIT	SK-KIT	CL-KIT	RP-KIT	LIFTERS	TIMING SET	ROCKER ARMS	PUSHRODS	VALVE SPRINGS	RETAINERS	VALVE LOCKS	VALVE SEALS
MAGNUM Hydraulic Roller Camshafts (W/ BALANCE SHAFT)											
N/A	N/A	N/A	N/A	850-12 ¹¹ 875-12 ¹¹	3202	1417-12 ⁹ 1617-12 ⁹	7808-12 7940-12	983-12 986-12 ²	751-12 740-12	611-12	502-12 503-12 ²
N/A	N/A	N/A	N/A	850-12 ¹¹ 875-12 ¹¹	3202	1417-12 ⁹ 1617-12 ⁹	7808-12 7940-12	983-12 986-12 ²	751-12 740-12	611-12	502-12 503-12 ²
N/A	N/A	N/A	N/A	850-12 ¹¹ 875-12 ¹¹	3202	1417-12 ⁹ 1617-12 ⁹	7808-12 7940-12	983-12 986-12 ²	751-12 740-12	611-12 614-12	503-12 ²
MAGNUM Computer Controlled Hydraulic Roller Camshafts (W/ BALANCE SHAFT)											
N/A	N/A	N/A	N/A	850-12 ¹¹ 875-12 ¹¹	3202	1417-12 ⁹ 1617-12 ⁹	7808-12 7940-12	983-12 986-12 ²	751-12 740-12	611-12	502-12 503-12 ²
N/A	N/A	N/A	N/A	850-12 ¹¹ 875-12 ¹¹	3202	1417-12 ⁹ 1617-12 ⁹	7808-12 7940-12	983-12 986-12 ²	751-12 740-12	611-12	502-12 503-12 ²
N/A	N/A	N/A	N/A	850-12 ¹¹ 875-12 ¹¹	3202	1417-12 ⁹ 1617-12 ⁹	7808-12 7940-12	986-12 26986-12	750-12 795-12	611-12 614-12	503-12 ²

¹¹ Lifters only, does not include lifter retainers or guides

³⁷ Adjustable valve train required



CHEVROLET 262-400 C.I. 8 CYL. 1958-1998

APPLICATIONS/CAMSHAFTS	VALVE SETTING		RPM OPERATING RANGE	CAM PART #	CAM GRIND #	DURATION				VALVE LIFT		LOBE SEP. ANGLE
	IN.	EX.				ADVERTISED IN.	EX.	@ .050" IN.	EX.	W/ 1.5 ROCKER IN.	EX.	
PURE ENERGY™ Hydraulic Flat Tappet Camshaft (C.A.R.B. Approved See Footnote #49 Below)												
HYDRAULIC – 50-State legal performance upgrade for 1987 & earlier carbureted V8 Small Block Chevy.	Hyd.	Hyd.	1200 to 5200	12-305-2⁴⁹	246PE	246	263	203	212	.429	.438	110°
HIGH ENERGY™ Hydraulic Flat Tappet Camshafts (C.A.R.B. Approved See Footnote #49 Below)												
HYDRAULIC – Strong torque, excellent mileage for 262-305c.i. with high axle ratios, smooth idle.	Hyd.	Hyd.	600 to 4600	12-300-4⁴⁹	240H	240	248	192	200	.390	.390	108°
HYDRAULIC – Strong torque, excellent mileage for 327-400c.i., has smooth idle, likes high axle ratios.	Hyd.	Hyd.	800 to 4800	12-205-2⁴⁹	252H	252	252	206	206	.425	.425	110°
HYDRAULIC – Vans, pickups, 4WD and towing in 350c.i., good idle, strong mid-range torque.	Hyd.	Hyd.	1200 to 5200	12-206-2⁴⁹	260H	260	260	212	212	.440	.440	110°
HYDRAULIC – Good street performance with stock converter, choppy idle.	Hyd.	Hyd.	1500 to 5500	12-210-2⁴⁹	268H	268	268	218	218	.454	.454	110°
HIGH ENERGY MARINE™ Hydraulic Flat Tappet Camshafts												
HYDRAULIC – Single or dual engine with inboard/outboard drive for ski and economy.	Hyd.	Hyd.	1800 to 4900	12-206-2⁴⁹	260H	260	260	212	212	.440	.440	110°
HYDRAULIC – Biggest cam for inboard/outboard. Good for ski, economy and some performance.	Hyd.	Hyd.	2200 to 5200	12-210-2⁴⁹	268H	268	268	218	218	.454	.454	110°
HYDRAULIC – Good for jet boat with A impeller, strong mid-range power.	Hyd.	Hyd.	2400 to 5400	12-318-4	268AH	268	276	222	226	.464	.464	110°
HYDRAULIC – High performance in 350-400 engines, strong off-shore cam.	Hyd.	Hyd.	2600 to 5700	12-324-4	280AH	280	288	232	237	.483	.483	110°
MAGNUM Hydraulic Flat Tappet Camshafts												
HYDRAULIC – High performance. Biggest cam w/ stock converter but better w/ 2000+ stall. Use lower gears. Mild rough idle.	Hyd.	Hyd.	1800 to 5800	12-211-2	270H	270	270	224	224	.470	.470	110°
HYDRAULIC – Great for street machines. Needs 2500+stall, headers and gears. Rough idle.	Hyd.	Hyd.	2000 to 6000	12-212-2	280H	280	280	230	230	.480	.480	110°
HYDRAULIC – Needs 9:1 compression, 2800+ stall, headers, gears. Choppy idle.	Hyd.	Hyd.	2200 to 6200	12-326-4	286H	286	286	236	236	.490	.490	110°
HYDRAULIC – Street/strip special, 3000 stall, headers, gears, 9.5:1 compression. Very rough idle.	Hyd.	Hyd.	2500 to 6500	12-213-3	292H	292	292	244	244	.501	.501	110°
HYDRAULIC – Pro Street/bracket, limited street driving. Intake, gears, 3500+ stall. Racy idle. 10.5:1 comp.	Hyd.	Hyd.	3000 to 7000	12-214-4	305H	305	305	253	253	.525	.525	110°
XTREME ENERGY™ Hydraulic Flat Tappet Camshafts												
HYDRAULIC – Very strong torque, excellent mileage, smooth idle.	Hyd.	Hyd.	600 to 4600	12-230-2	XE250H	250	260	206	212	.432	.444	110°
HYDRAULIC – Strong torque thru low end and mid-range, good idle.	Hyd.	Hyd.	1000 to 5200	12-234-2	XE256H	256	268	212	218	.447	.454	110°
HYDRAULIC – Excellent response, good mid-range, noticeable idle.	Hyd.	Hyd.	1300 to 5600	12-238-2	XE262H	262	270	218	224	.462	.469	110°
HYDRAULIC – Great for street machines, largest cam for stock converter, better with 2000+ stall.	Hyd.	Hyd.	1600 to 5800	12-242-2	XE268H	268	280	224	230	.477	.480	110°

² Requires machining on cylinder heads
⁷ Stock springs cannot be used

¹⁵ 50-State legal on 1993 & earlier SB Chevrolet V8, 262-400c.i. C.A.R.B. E.O. #D-279-410

CHEVROLET 262-400 C.I. 8 CYL. 1958-1998

CAMSHAFTS GENERAL MOTORS

K-KIT	SK-KIT	CL-KIT	RP-KIT	LIFTERS	TIMING SET	ROCKER ARMS	PUSHRODS	VALVE SPRINGS	STEEL RETAINERS	VALVE LOCKS	VALVE SEALS
PURE ENERGY™ Hydraulic Flat Tappet Camshaft (C.A.R.B. Approved See Footnote #49 Below)											
K12-305-2	SK12-305-2	CL12-305-2	RP1412-16 RPM1601-16	812-16 858-16	3200 2100	1412-16 ^{15,52} 1601-16 ^{15,52}	7812-16 7372-16	980-16 981-16	742-16 750-16	601-16 613-16	501-16
HIGH ENERGY™ Hydraulic Flat Tappet Camshafts (C.A.R.B. Approved See Footnote #49 Below)											
K12-300-4	SK12-300-4	CL12-300-4	RP1412-16 RPM1601-16	812-16 858-16	3200 2100	1412-16 ^{15,52} 1601-16 ^{15,52}	7812-16 7372-16	980-16 981-16	742-16 750-16	601-16 613-16	501-16
K12-205-2	SK12-205-2	CL12-205-2	RP1412-16 RPM1601-16	812-16 858-16	3200 2100	1412-16 ^{15,52} 1601-16 ^{15,52}	7812-16 7372-16	980-16 981-16	742-16 750-16	601-16 613-16	501-16
K12-206-2	SK12-206-2	CL12-206-2	RP1412-16 RPM1601-16	812-16 858-16	3200 2100	1412-16 ^{15,52} 1601-16 ^{15,52}	7812-16 7372-16	980-16 981-16	742-16 750-16	601-16 613-16	501-16
K12-210-2	SK12-210-2 ⁷	CL12-210-2 ⁷	RP1412-16 RPM1601-16	812-16 858-16	3200 2100	1412-16 ^{15,52} 1601-16 ^{15,52}	7812-16 7372-16	981-16 26981-16	742-16 787-16	601-16 648-16	501-16
HIGH ENERGY MARINE™ Hydraulic Flat Tappet Camshafts											
K12-206-2	SK12-206-2	CL12-206-2	RP1412-16 RPM1601-16	812-16 858-16	3200 2100	1412-16 ^{15,52} 1601-16 ^{15,52}	7372-16 7972-16	981-16 26981-16	742-16 787-16	601-16 648-16	501-16
K12-210-2	SK12-210-2 ⁷	CL12-210-2 ⁷	RP1412-16 RPM1601-16	812-16 858-16	3200 2100	1412-16 ^{15,52} 1601-16 ^{15,52}	7372-16 7972-16	981-16 26981-16	742-16 787-16	601-16 648-16	501-16
N/A	N/A	N/A	RP1412-16 RPM1601-16	812-16 858-16	2100 3100	1412-16 ^{15,52} 1601-16 ^{15,52}	7372-16 7972-16	981-16 26981-16	742-16 787-16	601-16 648-16	501-16
N/A	N/A	N/A	RP1412-16 RPM1601-16	812-16 858-16	2100 3100	1412-16 ^{15,52} 1601-16 ^{15,52}	7372-16 7972-16	981-16 26981-16	742-16 787-16	601-16 648-16	501-16
MAGNUM Hydraulic Flat Tappet Camshafts											
K12-211-2	SK12-211-2 ⁷	CL12-211-2 ⁷	RP1412-16 RPM1601-16	812-16 858-16	2100 3100	1412-16 ^{15,52} 1601-16 ^{15,52}	7372-16 7972-16	981-16 26981-16	742-16 787-16	601-16 648-16	501-16
K12-212-2	SK12-212-2 ⁷	CL12-212-2 ⁷	RP1412-16 RPM1601-16	812-16 858-16	2100 3100	1412-16 ^{15,52} 1601-16 ^{15,52}	7372-16 7972-16	981-16 26981-16	742-16 787-16	601-16 648-16	501-16
K12-326-4	SK12-326-4 ⁷	CL12-326-4 ⁷	RP1412-16 RPM1601-16	812-16 858-16	2100 3100	1412-16 ^{15,52} 1601-16 ^{15,52}	7372-16 7972-16	981-16 26981-16	742-16 787-16	601-16 648-16	501-16
K12-213-3	SK12-213-3 ⁷	CL12-213-3 ⁷	RP1412-16 RPM1601-16	812-16 858-16	2100 3100	1412-16 ^{15,52} 1601-16 ^{15,52}	7372-16 7972-16	986-16 ² 26986-16 ²	740-16 795-16	611-16 614-16	503-16 ²
K12-214-4	SK12-214-4 ⁷	CL12-214-4 ⁷	RP1412-16 RPM1601-16	812-16 858-16	2100 3100	1412-16 ^{15,52} 1601-16 ^{15,52}	7372-16 7972-16	986-16 ² 26986-16 ²	740-16 795-16	611-16 614-16	503-16 ²
XTREME ENERGY™ Hydraulic Flat Tappet Camshafts											
K12-230-2	SK12-230-2	CL12-230-2	RP1412-16 RPM1601-16	812-16 858-16	2100 3100	1412-16 ^{15,52} 1601-16 ^{15,52}	7812-16 7372-16	981-16 26981-16	742-16 787-16	601-16 648-16	501-16
K12-234-2	SK12-234-2 ⁷	CL12-234-2 ⁷	RP1412-16 RPM1601-16	812-16 858-16	2100 3100	1412-16 ^{15,52} 1601-16 ^{15,52}	7812-16 7372-16	981-16 26981-16	742-16 787-16	601-16 648-16	501-16
K12-238-2	SK12-238-2 ⁷	CL12-238-2 ⁷	RP1412-16 RPM1601-16	812-16 858-16	2100 3100	1412-16 ^{15,52} 1601-16 ^{15,52}	7812-16 7372-16	981-16 26981-16	742-16 787-16	601-16 648-16	501-16
K12-242-2	SK12-242-2 ⁷	CL12-242-2 ⁷	RP1412-16 RPM1601-16	812-16 858-16	2100 3100	1412-16 ^{15,52} 1601-16 ^{15,52}	7812-16 7372-16	981-16 26981-16	742-16 787-16	601-16 648-16	501-16

⁴⁹ 50-State legal for 1987 & earlier carbureted V8 SB Chevrolet 262-400 C.A.R.B. E.O. #D-279-3, #D-279-5, #D-279-6

⁵² Engines with self-aligning rocker arms must use Part #1417-16 or #1617-16

RED NUMBERS DENOTE PREMIUM OPTION



CHEVROLET 262-400 C.I. 8 CYL. 1958-1998 (CONTINUED)

APPLICATIONS/CAMSHAFTS	VALVE SETTING		RPM OPERATING RANGE	CAM PART #	CAM GRIND #	DURATION				VALVE LIFT		LOBE SEP. ANGLE
	IN.	EX.				ADVERTISED IN.	EX.	@ .050" IN.	EX.	W/ 1.5 ROCKER IN.	EX.	
XTREME ENERGY™ Hydraulic Flat Tappet Camshafts (CONTINUED)												
HYDRAULIC – Very strong mid-range torque and throttle response, 2200+ stall.	Hyd.	Hyd.	1800 to 6000	12-246-3 12-246-20⁹⁴	XE274H	274	286	230	236	.490	.490	110°
HYDRAULIC – Street/strip, 2800+ stall, likes headers and gears, rough idle.	Hyd.	Hyd.	2300 to 6500	12-250-3 12-250-20⁹⁴	XE284H	284	296	240	246	.507	.510	110°
HYDRAULIC – Pro Street/bracket, needs good intake, headers, gear and 3300+ stall.	Hyd.	Hyd.	2800 to 7000	12-254-3 12-254-20⁹⁴	XE294H	294	306	250	256	.519	.523	110°
XTREME ENERGY™ Computer Controlled Hydraulic Flat Tappet Camshafts (1987-1998)												
HYDRAULIC – Great in throttle body, crossfire or carbureted engine and 305 TPI.	Hyd.	Hyd.	1000 to 5000	12-249-4	XE249H	249	260	206	212	.434	.444	112°
HYDRAULIC – Best in 305 or 350 tuned port injected engines.	Hyd.	Hyd.	1200 to 5200	12-256-4	XE256H	256	268	212	218	.449	.456	112°
HYDRAULIC – Good for TPI 305 or 350 with after-market chip and upgraded exhaust.	Hyd.	Hyd.	1500 to 5500	12-262-4	XE262H	262	270	218	224	.464	.470	114°
HYDRAULIC – Best cam for modified 350 TPI with improved chip, injectors, plenum, runners and exhaust.	Hyd.	Hyd.	1800 to 5800	12-268-4	XE268H	268	280	224	230	.477	.480	114°

APPLICATIONS/CAMSHAFTS	VALVE SETTING		RPM OPERATING RANGE	CAM PART #	CAM GRIND #	DURATION				VALVE LIFT		LOBE SEP. ANGLE
	IN.	EX.				ADVERTISED IN.	EX.	@ .050" IN.	EX.	W/ 1.5 ROCKER IN.	EX.	
THUMPR™ Hydraulic Flat Tappet Camshafts												
HYDRAULIC – Thumpr™ – High performance street, stock converter ok, best with 2000+ converter and gears. Choppy/thumping idle.	Hyd.	Hyd.	2000 to 5800	12-600-4 12-600-20⁹⁴	279TH7	279	297	227	241	.479	.465	107°
HYDRAULIC – Mutha' Thumpr™ – High performance street/strip, needs 9:1 compression, 2500+ stall, intake, gears and headers, rough idle.	Hyd.	Hyd.	2200 to 6100	12-601-4 12-601-20⁹⁴	287TH7	287	305	235	249	.489	.476	107°
HYDRAULIC – Big Mutha' Thumpr™ – Street/strip, needs 9.5:1 compression, 2800+ stall, intake, gears and headers, very rough idle.	Hyd.	Hyd.	2500 to 6400	12-602-4 12-602-20⁹⁴	295TH7	295	313	243	257	.500	.486	107°

APPLICATIONS/CAMSHAFTS	VALVE SETTING		RPM OPERATING RANGE	CAM PART #	CAM GRIND #	DURATION				VALVE LIFT		LOBE SEP. ANGLE
	IN.	EX.				ADVERTISED IN.	EX.	@ .050" IN.	EX.	W/ 1.5 ROCKER IN.	EX.	
XTREME 4X4™ Hydraulic Flat Tappet Camshafts												
HYDRAULIC – Very strong torque, smooth idle, excellent mileage.	Hyd.	Hyd.	600 to 4600	12-231-2	X4250H	250	258	206	214	.432	.453	111°
HYDRAULIC – Strong low end and mid-range torque, good idle.	Hyd.	Hyd.	1000 to 5200	12-235-2	X4254H	254	262	210	218	.447	.462	111°
HYDRAULIC – Excellent response, good mid-range, noticeable idle.	Hyd.	Hyd.	1300 to 5600	12-239-3	X4262H	262	270	218	226	.462	.480	111°
HYDRAULIC – Strong mid-range and throttle response, likes headers, gears, 2200+ stall.	Hyd.	Hyd.	1800 to 6000	12-243-3	X4270H	270	278	226	234	.480	.498	111°

² Requires machining on cylinder heads
⁷ Stock springs cannot be used

¹⁵ 50-State legal on 1993 & earlier SB Chevrolet V8, 262-400c.i. C.A.R.B. E.O. #D-279-4

⁵² Engines with self-aligning rocker arms must use Part #1417-16 or #1617-16

CHEVROLET 262-400 C.I. 8 CYL. 1958-1998 (CONTINUED)

CAMSHAFTS
GENERAL MOTORS

K-KIT	SK-KIT	CL-KIT	RP-KIT	LIFTERS	TIMING SET	ROCKER ARMS	PUSHRODS	VALVE SPRINGS	RETAINERS	VALVE LOCKS	VALVE SEALS
XTREME ENERGY™ Hydraulic Flat Tappet Camshafts (CONTINUED)											
K12-246-3	SK12-246-3 ⁷	CL12-246-3 ⁷	RP1412-16 RPM1601-16	812-16 858-16	2100 3100	1412-16 ^{15,52} 1601-16 ^{15,52}	7812-16 7372-16	981-16 26981-16	742-16 787-16	601-16 648-16	501-16
K12-250-3	SK12-250-3 ⁷	CL12-250-3 ⁷	RP1412-16 RPM1601-16	812-16 858-16	2100 3100	1412-16 ^{15,52} 1601-16 ^{15,52}	7812-16 7372-16	986-16 ² 26986-16 ²	740-16 795-16	611-16 614-16	503-16 ²
K12-254-3	SK12-254-3 ⁷	CL12-254-3 ⁷	RP1412-16 RPM1601-16	812-16 858-16	2100 3100	1412-16 ^{15,52} 1601-16 ^{15,52}	7812-16 7372-16	986-16 ² 26986-16 ²	740-16 795-16	611-16 614-16	503-16 ²
XTREME ENERGY™ Computer Controlled Hydraulic Flat Tappet Camshafts (1987-1998)											
K12-249-4	SK12-249-4	CL12-249-4	RP1412-16 RPM1601-16	812-16 858-16	2100 3100	1412-16 ^{15,52} 1601-16 ^{15,52}	7812-16 7372-16	981-16 26981-16	742-16 787-16	601-16 648-16	501-16
K12-256-4	SK12-256-4 ⁷	CL12-256-4 ⁷	RP1412-16 RPM1601-16	812-16 858-16	2100 3100	1412-16 ^{15,52} 1601-16 ^{15,52}	7812-16 7372-16	981-16 26981-16	742-16 787-16	601-16 648-16	501-16
K12-262-4	SK12-262-4 ⁷	CL12-262-4 ⁷	RP1412-16 RPM1601-16	812-16 858-16	2100 3100	1412-16 ^{15,52} 1601-16 ^{15,52}	7812-16 7372-16	981-16 26981-16	742-16 787-16	601-16 648-16	501-16
K12-268-4	SK12-268-4 ⁷	CL12-268-4 ⁷	RP1412-16 RPM1601-16	812-16 858-16	2100 3100	1412-16 ^{15,52} 1601-16 ^{15,52}	7812-16 7372-16	981-16 26981-16	742-16 787-16	601-16 648-16	501-16
K-KIT	GK-KIT	CL-KIT	LIFTERS	TIMING SET	GEAR DRIVE	ROCKER ARMS	PUSHRODS	VALVE SPRINGS	RETAINERS	VALVE LOCKS	VALVE SEALS
THUMPR™ Hydraulic Flat Tappet Camshafts											
K12-600-4	GK12-600-4 ^{7,93}	CL12-600-4 ⁷	812-16 858-16	2100 3100	4100	1412-16 ^{15,52} 1601-16 ^{15,52}	7372-16 7972-16	981-16 26981-16	742-16 795-16	601-16 611-16	501-16
K12-601-4	GK12-601-4 ^{7,93}	CL12-601-4 ⁷	812-16 858-16	2100 3100	4100	1412-16 ^{15,52} 1601-16 ^{15,52}	7372-16 7972-16	981-16 26981-16	742-16 795-16	601-16 611-16	501-16
K12-602-4	GK12-602-4 ^{7,93}	CL12-602-4 ⁷	812-16 858-16	2100 3100	4100	1412-16 ^{15,52} 1601-16 ^{15,52}	7372-16 7972-16	986-16 ² 26986-16 ²	742-16 795-16	601-16 611-16	503-16 ²
K-KIT	SK-KIT	CL-KIT	RP-KIT	LIFTERS	TIMING SET	ROCKER ARMS	PUSHRODS	VALVE SPRINGS	RETAINERS	VALVE LOCKS	VALVE SEALS
XTREME 4X4™ Hydraulic Flat Tappet Camshafts											
K12-231-2	SK12-231-2	CL12-231-2	RP1412-16 RPM1601-16	812-16 858-16	3200 2100	1412-16 ^{15,52} 1601-16 ^{15,52}	7812-16 7372-16	981-16 26981-16	742-16 787-16	601-16 648-16	501-16
K12-235-2	SK12-235-2 ⁷	CL12-235-2 ⁷	RP1412-16 RPM1601-16	812-16 858-16	3200 2100	1412-16 ^{15,52} 1601-16 ^{15,52}	7812-16 7372-16	981-16 26981-16	742-16 787-16	601-16 648-16	501-16
K12-239-3	SK12-239-3 ⁷	CL12-239-3 ⁷	RP1412-16 RPM1601-16	812-16 858-16	3200 2100	1412-16 ^{15,52} 1601-16 ^{15,52}	7812-16 7372-16	981-16 26981-16	742-16 787-16	601-16 648-16	501-16
K12-243-3	SK12-243-3 ⁷	CL12-243-3 ⁷	RP1412-16 RPM1601-16	812-16 858-16	3200 2100	1412-16 ^{15,52} 1601-16 ^{15,52}	7812-16 7372-16	981-16 26981-16	742-16 787-16	601-16 648-16	501-16

⁹³ GK-Kit contains cam, lifters & gear drive

⁹⁴ Nitrided version

CHEVROLET 262-400 C.I. 8 CYL. 1958-1998 (CONTINUED)

APPLICATIONS/CAMSHAFTS	VALVE SETTING		RPM OPERATING RANGE	CAM PART #	CAM GRIND #	DURATION				VALVE LIFT		LOBE SEP. ANGLE
	IN.	EX.				ADVERTISED IN.	EX.	@ .050" IN.	EX.	W/ 1.5 ROCKER IN.	EX.	
XTREME MARINE™ Hydraulic Flat Tappet Camshafts												
HYDRAULIC – Good for inboard/outboard pleasure boat, skiing and good economy.	Hyd.	Hyd.	1000 to 5000	12-232-3	XM256H	256	262	212	218	.447	.462	112°
HYDRAULIC – Biggest cam for inboard/outboard, good mid-range with excellent response, noticeable idle.	Hyd.	Hyd.	1300 to 5500	12-236-3	XM262H	262	268	218	224	.462	.477	112°
HYDRAULIC – Jet boat with A impeller, strong mid-range, good throttle response, noticeable idle.	Hyd.	Hyd.	1600 to 5800	12-240-4	XM270H	270	286	226	236	.480	.489	112°
HYDRAULIC – Jet boat with A or B impeller, good off-shore high performance cam, rough idle.	Hyd.	Hyd.	2000 to 6200	12-244-4	XM278H	278	292	234	244	.498	.500	112°
HYDRAULIC – Jet boat with A impeller, 9.5:1 compression, needs headers. Good for bracket racing and high performance.	Hyd.	Hyd.	2500 to 6500	12-248-4	XM290H	290	306	246	256	.516	.522	112°
DUAL ENERGY™ Hydraulic Flat Tappet Camshafts												
HYDRAULIC – Strong torque and mileage. Excellent RV and towing cam. Smooth idle.	Hyd.	Hyd.	1200 to 5500	12-207-2⁴⁹	255DEH	255	261	203	212	.421	.451	110°
HYDRAULIC – Very strong mid-range. Lopey idle. Everyday performance for stock exhaust.	Hyd.	Hyd.	1500 to 5750	12-208-2⁴⁹	265DEH	265	269	211	221	.442	.465	110°
HYDRAULIC – High performance street. Works with stock converter. Choppy idle.	Hyd.	Hyd.	2000 to 6000	12-209-2	275DEH	275	277	219	229	.462	.482	110°
NOSTALGIA PLUS™ Hydraulic Flat Tappet Camshafts												
HYDRAULIC – Sound of GM 300 HP camshaft with improved power and response.	Hyd.	Hyd.	1000 to 5500	12-670-4	N+300HP	258	265	211	218	.426	.420	112°
HYDRAULIC – Sound and character of the ever popular GM L79 cam with modern power	Hyd.	Hyd.	1800 to 6200	12-671-4	N+L79H	276	283	229	236	.468	.462	112°
HYDRAULIC – Exhaust note of GM 30-30 cam with increased performance.	Hyd.	Hyd.	2300 to 6500	12-672-4	N+30-30H	286	293	239	246	.483	.477	112°
FACTORY MUSCLE™ Hydraulic Flat Tappet Camshafts (Today's OEM Versions Of Yesterday's Muscle Car Cams)												
HYDRAULIC – Factory I.D. #3896929 for: 327c.i., 1965-68, factory 275/300 HP 350c.i., 1967-69, factory 295 HP 350c.i., 1970, factory 300 HP 350c.i., 1971, factory 270 HP 350c.i., 1972, factory 200 HP	Hyd.	Hyd.	600 to 4800	12-105-3	929H	319	320	195	202	.390	.410	112°
HYDRAULIC – Factory I.D. #3863151 for: 327c.i., 1965-68, factory 350 HP 327c.i., 1967-68, factory 325 HP	Hyd.	Hyd.	1800 to 5800	12-106-3	151H	342	342	222	222	.447	.447	114°

TECH TIP

If you have a 1955-1957 Small Block Chevy engine, please notify your sales person before ordering.

² Requires machining on cylinder heads
⁷ Stock springs cannot be used

¹⁵ 50-State legal on 1993 & earlier SB Chevrolet V8, 262-400c.i. C.A.R.B. E.O. #D-279-4

⁴⁹ 50-State legal for 1987 & earlier carbureted V8 SB Chevrolet 262-400 C.A.R.B. E.O. #D-279-3, #D-279-5, #D-279-6

CHEVROLET 262-400 C.I. 8 CYL. 1958-1998 (CONTINUED)

CAMSHAFTS
GENERAL MOTORS

K-KIT	SK-KIT	CL-KIT	RP-KITS	LIFTERS	TIMING SET	ROCKER ARMS	PUSHRODS	VALVE SPRINGS	RETAINERS	VALVE LOCKS	VALVE SEALS	
XTREME MARINE™ Hydraulic Flat Tappet Camshafts												
K12-232-3	SK12-232-3 ⁷	CL12-232-3 ⁷	RP1412-16 RPM1601-16	812-16 858-16	3200 2100	1412-16 ^{15,52} 1601-16 ^{15,52}	7372-16 7972-16	981-16 26981-16	742-16 787-16	601-16 648-16	501-16	
K12-236-3	SK12-236-3 ⁷	CL12-236-3 ⁷	RP1412-16 RPM1601-16	812-16 858-16	3200 2100	1412-16 ^{15,52} 1601-16 ^{15,52}	7372-16 7972-16	981-16 26981-16	742-16 787-16	601-16 648-16	501-16	
K12-240-4	SK12-240-4 ⁷	CL12-240-4 ⁷	RP1412-16 RPM1601-16	812-16 858-16	3200 2100	1412-16 ^{15,52} 1601-16 ^{15,52}	7372-16 7972-16	981-16 26981-16	742-16 787-16	601-16 648-16	501-16	
K12-244-4	SK12-244-4 ⁷	CL12-244-4 ⁷	RP1412-16 RPM1601-16	812-16 858-16	2100 3100	1412-16 ^{15,52} 1601-16 ^{15,52}	7372-16 7972-16	986-16 ² 26986-16 ²	740-16 795-16	611-16 614-16	503-16 ²	
K12-248-4	SK12-248-4 ⁷	CL12-248-4 ⁷	RP1412-16 RPM1601-16	812-16 858-16	2100 3100	1412-16 ^{15,52} 1601-16 ^{15,52}	7372-16 7972-16	986-16 ² 26986-16 ²	740-16 795-16	611-16 614-16	503-16 ²	
DUAL ENERGY™ Hydraulic Flat Tappet Camshafts												
K12-207-2	SK12-207-2	CL12-207-2	RP1412-16 RPM1601-16	812-16 858-16	3200 2100	1412-16 ^{15,52} 1601-16 ^{15,52}	7812-16 7372-16	980-16 981-16	742-16 750-16	601-16 613-16	501-16	
K12-208-2	SK12-208-2 ⁷	CL12-208-2 ⁷	RP1412-16 RPM1601-16	812-16 858-16	3200 2100	1412-16 ^{15,52} 1601-16 ^{15,52}	7812-16 7372-16	981-16 26981-16	742-16 787-16	601-16 648-16	501-16	
K12-209-2	SK12-209-2 ⁷	CL12-209-2 ⁷	RP1412-16 RPM1601-16	812-16 858-16	3200 2100	1412-16 ^{15,52} 1601-16 ^{15,52}	7812-16 7372-16	981-16 26981-16	742-16 787-16	601-16 648-16	501-16	
NOSTALGIA PLUS™ Hydraulic Flat Tappet Camshafts												
K12-670-4	SK12-670-4	CL12-670-4	RP1412-16 RPM1601-16	812-16 858-16	3200 2100	1412-16 ^{15,52} 1601-16 ^{15,52}	7812-16 7372-16	981-16 26981-16	742-16 787-16	601-16 648-16	501-16	
K12-671-4	SK12-671-4	CL12-671-4	RP1412-16 RPM1601-16	812-16 858-16	3200 2100	1412-16 ^{15,52} 1601-16 ^{15,52}	7812-16 7372-16	981-16 26981-16	742-16 787-16	601-16 648-16	501-16	
K12-672-4	SK12-672-4 ⁷	CL12-672-4 ⁷	RP1412-16 RPM1601-16	812-16 858-16	3200 2100	1412-16 ^{15,52} 1601-16 ^{15,52}	7812-16 7372-16	981-16 26981-16	742-16 787-16	601-16 648-16	501-16	
LIFTERS	TIMING SET	ROCKER ARMS	PUSHRODS	VALVE SPRINGS	RETAINERS	VALVE LOCKS	VALVE SEALS	LASH CAPS	REV KIT	DIST. GEAR	STUD GIRDLES	
FACTORY MUSCLE™ Hydraulic Flat Tappet Camshafts (Today's OEM Versions Of Yesterday's Muscle Car Cams)												
812-16 858-16	2100 3100	1412-16 ^{15,52} 1601-16 ^{15,52}	7812-16 7372-16	980-16 981-16	742-16 750-16	601-16 611-16	501-16 503-16 ²	621-16	N/A	12200	4001	
812-16 858-16	2100 3100	1412-16 ^{15,52} 1601-16 ^{15,52}	7812-16 7372-16	981-16 26981-16	750-16 795-16	613-16 611-16	501-16	621-16	N/A	12200	4001	

⁵² Engines with self-aligning rocker arms must use Part #1417-16 or #1617-16

CHEVROLET 262-400 C.I. 8 CYL. 1958-1998 (CONTINUED)

APPLICATIONS/CAMSHAFTS	VALVE SETTING		RPM OPERATING RANGE	CAM PART #	CAM GRIND #	DURATION				VALVE LIFT		LOBE SEP. ANGLE
	IN.	EX.				ADVERTISED IN.	EX.	@ .050" IN.	EX.	W/ 1.5 ROCKER IN.	EX.	
NITROUS HP™ Hydraulic Flat Tappet Camshafts												
HYDRAULIC – Works well in near stock engines with up to 125 hp nitrous kits.	Hyd.	Hyd.	1200 to 5600	12-552-4	NX256H	256	268	212	222	.434	.464	113°
HYDRAULIC – High performance street. With 100-150 hp nitrous kit or small blower.	Hyd.	Hyd.	1600 to 5900	12-556-4	NX262H	262	280	218	230	.462	.480	113°
HYDRAULIC – Street machines with 125+ hp kit, 2200+ stall, gears, choppy idle.	Hyd.	Hyd.	2000 to 6200	12-560-4	NX268H	268	286	224	236	.477	.490	113°
HYDRAULIC – Street/strip applications, 125+ hp kit or medium blower, 2500+ stall. Rough idle.	Hyd.	Hyd.	2400 to 6500	12-564-4	NX274H	274	292	230	244	.487	.501	113°
HYDRAULIC – Pro Street applications, excellent for multi-stage kits or 671 blower. 2800+ stall.	Hyd.	Hyd.	2800 to 6800	12-568-4	NX284H	284	305	240	253	.507	.525	113°
XTREME FUEL INJECTION (XFI™) Hydraulic Flat Tappet Camshafts (WITH 1.6 ROCKERS)												
HYDRAULIC – Excellent throttle body cam. Superb for crossfire or carbureted engines. Lots of torque.	Hyd.	Hyd.	1300 to 5300	12-364-4	252XFI H13	252	266	208	217	.477	.472	113°
HYDRAULIC – Good low end and mid-range for TPI 350 with aftermarket chip and upgraded exhaust.	Hyd.	Hyd.	1500 to 5500	12-365-4	260XFI H13	260	272	216	223	.499	.493	113°
HYDRAULIC – Excellent mid-range for TPI 350 with chip upgrade, injectors, plenum and exhaust system. 2000+ stall.	Hyd.	Hyd.	2000 to 6000	12-366-4	268XFI H13	268	280	224	231	.520	.515	113°
HYDRAULIC – Good mid-range with exceptional top end. Requires chip, gear, plenum and exhaust mods. 2500+ stall.	Hyd.	Hyd.	2400 to 6400	12-367-4	280XFI H13	280	290	236	241	.552	.547	113°
HYDRAULIC – Best results at wide-open throttle. All mods a must. 2800+ stall needed.	Hyd.	Hyd.	2800 to 6800	12-368-4	292XFI H13	292	302	248	253	.584	.579	113°
COMPUTER CONTROLLED Hydraulic Flat Tappet Camshafts												
HYDRAULIC – Good vacuum and mileage for any size computer engine.	Hyd.	Hyd.	700 to 4700	12-304-4	252BH-11	252	252	201	206	.406	.406	111°
HYDRAULIC – For use in throttle body injection, crossfire and TPI 305 and 350 engine.	Hyd.	Hyd.	1000 to 5000	12-388-4	252AH-12	252	260	206	212	.425	.440	112°
HYDRAULIC – For 350 tuned port injected engines with performance chip or programmer.	Hyd.	Hyd.	1200 to 5200	12-314-4	260AH-12	260	260	212	212	.444	.444	112°
HYDRAULIC – Good for stock TPI 350 or TPI 305 with modified computer or programmer.	Hyd.	Hyd.	1500 to 5500	12-402-4	260AH-14	260	268	212	218	.444	.444	114°
HYDRAULIC – Best cam for 350 TPI with programmer or modified computer.	Hyd.	Hyd.	1800 to 5800	12-404-4⁷	268AH-14	268	276	222	226	.464	.464	114°

² Requires machining on cylinder heads
⁷ Stock springs cannot be used

¹⁵ 50-State legal on 1993 & earlier SB Chevrolet V8, 262-400c.i. C.A.R.B. E.O. #D-279-4

⁵² Engines with self-aligning rocker arms must use Part #1417-16 or #1617-16

CHEVROLET 262-400 C.I. 8 CYL. 1958-1998 (CONTINUED)

CAMSHAFTS GENERAL MOTORS

K-KIT	SK-KIT	CL-KIT	RP-KIT	LIFTERS	TIMING SET	ROCKER ARMS	PUSHRODS	VALVE SPRINGS	RETAINERS	VALVE LOCKS	VALVE SEALS	
NITROUS HP™ Hydraulic Flat Tappet Camshafts												
K12-552-4	SK12-552-4 ⁷	CL12-552-4 ⁷	RP1412-16 RPM1601-16	812-16 858-16	2100 3100	1412-16 ^{15,52} 1601-16 ^{15,52}	7372-16 7972-16	981-16 26981-16	742-16 787-16	601-16 648-16	501-16	
K12-556-4	SK12-556-4 ⁷	CL12-556-4 ⁷	RP1412-16 RPM1601-16	812-16 858-16	2100 3100	1412-16 ^{15,52} 1601-16 ^{15,52}	7372-16 7972-16	981-16 26981-16	742-16 787-16	601-16 648-16	501-16	
K12-560-4	SK12-560-4 ⁷	CL12-560-4 ⁷	RP1412-16 RPM1601-16	812-16 858-16	2100 3100	1412-16 ^{15,52} 1601-16 ^{15,52}	7372-16 7972-16	981-16 26981-16	742-16 787-16	601-16 648-16	501-16	
K12-564-4	SK12-564-4 ⁷	CL12-564-4 ⁷	RP1412-16 RPM1601-16	812-16 858-16	2100 3100	1412-16 ^{15,52} 1601-16 ^{15,52}	7372-16 7972-16	986-16 ² 26986-16 ²	740-16 795-16	611-16 614-16	503-16 ²	
K12-568-4	SK12-568-4 ⁷	CL12-568-4 ⁷	RP1412-16 RPM1601-16	812-16 858-16	2100 3100	1412-16 ^{15,52} 1601-16 ^{15,52}	7372-16 7972-16	986-16 ² 26986-16 ²	740-16 795-16	611-16 614-16	503-16 ²	
XTREME FUEL INJECTION (XFI™) Hydraulic Flat Tappet Camshafts (WITH 1.6 ROCKERS)												
K12-364-4	SK12-364-4 ⁷	CL12-364-4 ⁷	RP1416-16	812-16 858-16	2100 3100	1412-16 ^{15,52} 1601-16 ^{15,52}	7812-16 7372-16	26981-16 26986-16 ²	787-16 1787-16	601-16 648-16	501-16 503-16 ²	
K12-365-4	SK12-365-4 ⁷	CL12-365-4 ⁷	RP1416-16	812-16 858-16	2100 3100	1412-16 ^{15,52} 1601-16 ^{15,52}	7812-16 7372-16	26981-16 26986-16 ²	787-16 1787-16	601-16 648-16	501-16 503-16 ²	
K12-366-4	SK12-366-4 ⁷	CL12-366-4 ⁷	RP1416-16	812-16 858-16	2100 3100	1412-16 ^{15,52} 1601-16 ^{15,52}	7812-16 7372-16	26981-16 26986-16 ²	787-16 1787-16	601-16 648-16	501-16 503-16 ²	
K12-367-4	SK12-367-4 ⁷	CL12-367-4 ⁷	RP1416-16	812-16 858-16	2100 3100	1412-16 ^{15,52} 1601-16 ^{15,52}	7812-16 7372-16	26986-16 ²	787-16 1787-16	601-16 648-16	501-16 503-16 ²	
K12-368-4	SK12-368-4 ⁷	CL12-368-4 ⁷	RP1416-16	812-16 858-16	2100 3100	1412-16 ^{15,52} 1601-16 ^{15,52}	7812-16 7372-16	26986-16 ²	787-16 1787-16	601-16 648-16	501-16 503-16 ²	

LIFTERS	TIMING SET	ROCKER ARMS	PUSHRODS	VALVE SPRINGS	RETAINERS	VALVE LOCKS	VALVE SEALS	LASH CAPS	REV KIT	DIST. GEAR	STUD GIRDLES
COMPUTER CONTROLLED Hydraulic Flat Tappet Camshafts											
812-16 858-16	2100 3100	1412-16 ^{15,52} 1601-16 ^{15,52}	7812-16 7372-16	981-16 26981-16	742-16 787-16	601-16 648-16	501-16	621-16	N/A	12200	4001
812-16 858-16	2100 3100	1412-16 ^{15,52} 1601-16 ^{15,52}	7812-16 7372-16	981-16 26981-16	742-16 787-16	601-16 648-16	501-16	621-16	N/A	12200	4001
812-16 858-16	2100 3100	1412-16 ^{15,52} 1601-16 ^{15,52}	7812-16 7372-16	981-16 26981-16	742-16 787-16	601-16 648-16	501-16	621-16	N/A	12200	4001
812-16 858-16	2100 3100	1412-16 ^{15,52} 1601-16 ^{15,52}	7812-16 7372-16	981-16 26981-16	742-16 787-16	601-16 648-16	501-16	621-16	N/A	12200	4001
858-16	2100 3100	1412-16 ^{15,52} 1601-16 ^{15,52}	7812-16 7372-16	981-16 26981-16	742-16 787-16	601-16 648-16	501-16	621-16	N/A	12200	4001

RED NUMBERS DENOTE PREMIUM OPTION

CHEVROLET 262-400 C.I. 8 CYL. 1958-1998 (CONTINUED)

APPLICATIONS/CAMSHAFTS	VALVE SETTING		RPM OPERATING RANGE	CAM PART #	CAM GRIND #	DURATION				VALVE LIFT		LOBE SEP. ANGLE
	IN.	EX.				IN.	EX.	@ .050"	IN.	EX.	W/ 1.5 ROCKER	
XTREME TURBO Hydraulic Flat Tappet Camshafts												
XTREME TURBO – Single turbo street applications with 5-10 lbs. of boost.	Hyd.	Hyd.	1200 to 5500	12-251-4	XT250H	250	257	206	206	.432	.426	110°
XTREME TURBO – Higher RPM street applications with 8-16 lbs. of boost.	Hyd.	Hyd.	1800 to 6000	12-252-4	XT256H	256	263	212	212	.447	.444	112°
XTREME TURBO – Street/strip applications. Single or dual turbos.	Hyd.	Hyd.	2200 to 6400	12-253-4	XT262H	262	269	218	218	.462	.455	114°
BLOWER & TURBO Hydraulic Flat Tappet Camshafts												
HYDRAULIC – Very mild street. Small under hood blower. Good torque.	Hyd.	Hyd.	1500 to 5500	12-402-4	260AH-14	260	268	212	218	.444	.444	114°
HYDRAULIC – Good upgrade for turbo charged OEM street engine. Good mid-range power.	Hyd.	Hyd.	1500 to 5500	12-400-4	268TH-15	268	260	218	212	.454	.444	115°
HYDRAULIC – Street machine using under hood blower with 10-12 lbs. of boost.	Hyd.	Hyd.	1800 to 5800	12-404-4	268AH-14	268	276	222	226	.464	.464	114°
XTREME ENERGY™ 4 & 7 SWAP FIRING ORDER Hydraulic Flat Tappet Camshafts												
18736542 Firing Order												
HYDRAULIC – Very strong mid-range torque and throttle response, 2500+ stall.	Hyd.	Hyd.	1800 to 6000	12-660-47	XE274H-10	274	286	230	236	.490	.490	110°
HYDRAULIC – Street/strip, 2800+ stall, needs headers and gear, rough idle.	Hyd.	Hyd.	2300 to 6500	12-661-47	XE284H-10	284	296	240	246	.507	.510	110°
HYDRAULIC – Pro Street/bracket, needs good intake, headers, gear and 3300+ stall.	Hyd.	Hyd.	2800 to 7000	12-662-47	XE294H-10	294	306	250	256	.519	.523	110°
DRAG RACE Hydraulic Flat Tappet Camshafts												
HYDRAULIC – 3000+ stall in heavy car, with 10:1+ compression.	Hyd.	Hyd.	2500 to 6500	12-213-3	292H-10	292	292	244	244	.501	.501	110°
HYDRAULIC – 10.5:1+ compression, 3500+ stall, good torque.	Hyd.	Hyd.	3000 to 6800	12-342-4	296AH-8	296	305	246	253	.510	.507	108°
HYDRAULIC – 4000+ stall, 11:1+ compression, medium weight car.	Hyd.	Hyd.	3500 to 6500	12-327-5	305H-6	305	305	253	253	.525	.525	106°
HYDRAULIC – 3500-4000 stall or 4 speed with 11:1+ compression.	Hyd.	Hyd.	3500 to 7000	12-214-4	305H-10	305	305	253	253	.525	.525	110°
OVAL TRACK Hydraulic Flat Tappet Camshafts												
HYDRAULIC – Best for heavy car, short track.	Hyd.	Hyd.	3000 to 6000	12-325-4	280AH-8	280	288	232	237	.483	.483	108°
HYDRAULIC – Best for 1/4 to 3/8 mile track, broad torque range.	Hyd.	Hyd.	3500 to 6300	12-330-4	286AH-8	286	292	236	244	.490	.485	108°
HYDRAULIC – Good for 3/8 to 1/2 mile track, 350 or larger engine.	Hyd.	Hyd.	3700 to 6500	12-344-5	296CH-6	296	305	246	253	.510	.525	106°
HYDRAULIC – Good for light cars on long tracks with fast corners.	Hyd.	Hyd.	4000 to 6800	12-327-5	305H-6	305	305	253	253	.525	.525	106°

² Requires machining on cylinder heads¹⁵ 50-State legal on 1993 & earlier SB Chevrolet V8, 262-400c.i. C.A.R.B. E.O. #D-279-4⁴⁸ Includes 3 cam bolts, thrust bearing, adjustable cam timing system, 2 machined steel gears & true roller chain

CHEVROLET 262-400 C.I. 8 CYL. 1958-1998 (CONTINUED)

CAMSHAFTS GENERAL MOTORS

LIFTERS	TIMING SET	ROCKER ARMS	PUSHRODS	VALVE SPRINGS	RETAINERS	VALVE LOCKS	VALVE SEALS	LASH CAPS	REV KIT	DIST. GEAR	STUD GIRDLES	
XTREME TURBO Hydraulic Flat Tappet Camshafts												
812-16 858-16	2100 3100	1412-16 ^{15,52} 1601-16 ^{15,52}	7812-16 7372-16	981-16 26981-16	742-16 787-16	601-16 648-16	501-16	621-16	N/A	12200	4001	
812-16 858-16	2100 3100	1412-16 ^{15,52} 1601-16 ^{15,52}	7812-16 7372-16	981-16 26981-16	742-16 787-16	601-16 648-16	501-16	621-16	N/A	12200	4001	
812-16 858-16	2100 3100	1412-16 ^{15,52} 1601-16 ^{15,52}	7812-16 7372-16	981-16 26981-16	742-16 787-16	601-16 648-16	501-16	621-16	N/A	12200	4001	
BLOWER & TURBO Hydraulic Flat Tappet Camshafts												
812-16 858-16	2100 3100	1412-16 ^{15,52} 1601-16 ^{15,52}	7372-16 7972-16	983-16 26981-16	751-16 795-16	611-16 614-16	501-16	621-16	N/A	12200	4001	
812-16 858-16	2100 3100	1412-16 ^{15,52} 1601-16 ^{15,52}	7372-16 7972-16	983-16 26981-16	751-16 795-16	611-16 614-16	501-16	621-16	N/A	12200	4001	
812-16 858-16	2100 3100	1412-16 ^{15,52} 1601-16 ^{15,52}	7372-16 7972-16	983-16 26981-16	751-16 795-16	611-16 614-16	501-16	621-16	N/A	12200	4001	
XTREME ENERGY™ 4 & 7 SWAP FIRING ORDER Hydraulic Flat Tappet Camshafts												
812-16 858-16	2100 7100	1601-16 ^{15,52} 1801-16 ¹⁵	7372-16 7972-16	986-16 ² 26986-16 ²	740-16 795-16	611-16 614-16	503-16 ²	621-16	N/A	12200	4001	
812-16 858-16	2100 7100	1601-16 ^{15,52} 1801-16 ¹⁵	7372-16 7972-16	986-16 ² 26986-16 ²	740-16 795-16	611-16 614-16	503-16 ²	621-16	N/A	12200	4001	
812-16 858-16	2100 7100	1601-16 ^{15,52} 1801-16 ¹⁵	7372-16 7972-16	986-16 ² 26986-16 ²	740-16 795-16	611-16 614-16	503-16 ²	621-16	N/A	12200	4001	
DRAG RACE Hydraulic Flat Tappet Camshafts												
858-16	3100 3100KT ⁴⁸	1601-16 ^{15,52} 1801-16 ¹⁵	7972-16	986-16 ² 26986-16 ²	740-16 795-16	611-16 614-16	503-16 ²	621-16	N/A	12200	4001	
858-16	3100 3100KT ⁴⁸	1601-16 ^{15,52} 1801-16 ¹⁵	7972-16	986-16 ² 26986-16 ²	740-16 795-16	611-16 614-16	503-16 ²	621-16	N/A	12200	4001	
858-16	3100 3100KT ⁴⁸	1601-16 ^{15,52} 1801-16 ¹⁵	7972-16	986-16 ² 26986-16 ²	740-16 795-16	611-16 614-16	503-16 ²	621-16	N/A	12200	4001	
858-16	3100 3100KT ⁴⁸	1601-16 ^{15,52} 1801-16 ¹⁵	7972-16	986-16 ² 26986-16 ²	740-16 795-16	611-16 614-16	503-16 ²	621-16	N/A	12200	4001	
OVAL TRACK Hydraulic Flat Tappet Camshafts												
858-16	3100 3100KT ⁴⁸	1601-16 ^{15,52} 1801-16 ¹⁵	7972-16	986-16 ² 26986-16 ²	740-16 795-16	611-16 614-16	503-16 ²	621-16	N/A	12200	4001	
858-16	3100 3100KT ⁴⁸	1601-16 ^{15,52} 1801-16 ¹⁵	7972-16	986-16 ² 26986-16 ²	740-16 795-16	611-16 614-16	503-16 ²	621-16	N/A	12200	4001	
858-16	3100 3100KT ⁴⁸	1601-16 ^{15,52} 1801-16 ¹⁵	7972-16	986-16 ² 26986-16 ²	740-16 795-16	611-16 614-16	503-16 ²	621-16	N/A	12200	4001	
858-16	3100 3100KT ⁴⁸	1601-16 ^{15,52} 1801-16 ¹⁵	7972-16	986-16 ² 26986-16 ²	740-16 795-16	611-16 614-16	503-16 ²	621-16	N/A	12200	4001	

⁵² Engines with self-aligning rocker arms must use Part #1417-16 or #1617-16



CHEVROLET 262-400 C.I. 8 CYL. 1958-1998 (CONTINUED)

APPLICATIONS/CAMSHAFTS	VALVE SETTING		RPM OPERATING RANGE	CAM PART #	CAM GRIND #	DURATION				VALVE LIFT		LOBE SEP. ANGLE
	IN.	EX.				IN.	EX.	IN.	EX.	IN.	EX.	
LOW LIFT OVAL TRACK Hydraulic Flat Tappet Camshafts												
HYDRAULIC – .400" lift rules. Rough idle. Low vacuum, under 10".	Hyd.	Hyd.	3000 to 6000	12-520-5	22/12 H-6	300	306	247	255	.399	.399	106°
HYDRAULIC – .420" lift rules. Rough idle. Low vacuum, under 10".	Hyd.	Hyd.	3000 to 6000	12-521-5	41/15 H-6	297	299	246	250	.420	.420	106°
HYDRAULIC – .450" lift rules. Rough idle. Low vacuum, under 10".	Hyd.	Hyd.	2500 to 6000	12-522-5	45/28 H-6	293	300	242	255	.450	.453	106°

APPLICATIONS/CAMSHAFTS	VALVE SETTING		RPM OPERATING RANGE	CAM PART #	CAM GRIND #	DURATION				VALVE LIFT		LOBE SEP. ANGLE
	IN.	EX.				IN.	EX.	IN.	EX.	IN.	EX.	
MAGNUM Retro-Fit Hydraulic Roller Camshafts												
HYDRAULIC ROLLER – Good mileage, smooth idle. Vans, pickups and towing. Stock rear gear ratios and torque converter.	Hyd.	Hyd.	1200 to 4500	12-410-8^{10,46}	260HR	260	260	206	206	.500	.500	110°
HYDRAULIC ROLLER – Mild street performance, slightly noticeable lobe at idle. Stock converter, aftermarket intake and headers. 3.40 to 4.10 rear gears.	Hyd.	Hyd.	1800 to 5000	12-420-8^{10,46}	270HR	270	270	215	215	.500	.500	110°
HYDRAULIC ROLLER – Limited high performance street. Aftermarket intake, headers, 2200+ stall, and 3.40 to 4.10 gears. Mild rough idle.	Hyd.	Hyd.	2000 to 5500	12-430-8^{10,46}	280HR	280	280	224	224	.525	.525	110°
HYDRAULIC ROLLER – Great for street machines. Best with headers and aftermarket intake. Rough idle. Limited vacuum. 2500+ stall.	Hyd.	Hyd.	2500 to 6000	12-450-8^{10,46}	286HR	286	286	230	230	.560	.560	110°
HYDRAULIC ROLLER – Street/strip applications. 3000+ stall. 3.90 lower gear ratio, intake and headers. Very rough idle.	Hyd.	Hyd.	3000 to 6500	12-460-8^{10,46}	304HR	304	304	244	244	.600	.600	110°
HYDRAULIC ROLLER – Limited street use and bracket racing. 10.5:1 compression 3500+ stall 4.10 gear. Needs headers and race intake. Radical idle.	Hyd.	Hyd.	3500 to 6500	12-470-8^{10,46}	314HR	314	314	252	252	.600	.600	110°

XTREME ENERGY™ Retro-Fit Hydraulic Roller Camshafts												
HYDRAULIC ROLLER – Good for mileage and for towing, smooth idle.	Hyd.	Hyd.	600 to 4600	12-407-8^{10,46}	XR252HR	252	258	200	206	.472	.480	110°
HYDRAULIC ROLLER – Strong torque, good mileage, stock to mildly modified combinations.	Hyd.	Hyd.	1000 to 5000	12-408-8^{10,46}	XR258HR	258	264	206	212	.480	.487	110°
HYDRAULIC ROLLER – Mild performance applications, very good mid-range, 3.23-3.73 gears.	Hyd.	Hyd.	1200 to 5200	12-412-8^{10,46}	XR264HR	264	270	212	218	.487	.495	110°
HYDRAULIC ROLLER – High performance application, largest with stock converter, noticeable idle.	Hyd.	Hyd.	1600 to 5400	12-422-8^{10,46}	XR270HR	270	276	218	224	.495	.502	110°
HYDRAULIC ROLLER – High performance street machines, 2000+ stall, gears, choppy idle.	Hyd.	Hyd.	1900 to 5600	12-423-8^{10,46}	XR276HR	276	282	224	230	.502	.510	110°

² Requires machining on cylinder heads
⁷ Stock springs cannot be used

¹⁰ Requires thrust button & wear plate

¹⁵ 50-State legal on 1993 & earlier SB Chevrolet V8, 262-400c.i. C.A.R.B. E.O. #D-279-4

CHEVROLET 262-400 C.I. 8 CYL. 1958-1998 (CONTINUED)

LIFTERS	TIMING SET	ROCKER ARMS	PUSHRODS	VALVE SPRINGS	RETAINERS	VALVE LOCKS	VALVE SEALS	LASH CAPS	REV KIT	DIST. GEAR	STUD GIRDLES	
LOW LIFT OVAL TRACK Hydraulic Flat Tappet Camshafts												
858-16	3100 3100KT ⁴⁸	1601-16 ^{15,52} 1801-16 ¹⁵	7972-16	983-16 ² 26986-16 ²	751-16 795-16	611-16 614-16	501-16 503-16 ²	621-16	N/A	12200	4001	
858-16	3100 3100KT ⁴⁸	1601-16 ^{15,52} 1801-16 ¹⁵	7972-16	983-16 ² 26986-16 ²	751-16 795-16	611-16 614-16	501-16 503-16 ²	621-16	N/A	12200	4001	
858-16	3100 3100KT ⁴⁸	1601-16 ^{15,52} 1801-16 ¹⁵	7972-16	983-16 ² 26986-16 ²	751-16 795-16	611-16 614-16	501-16 503-16 ²	621-16	N/A	12200	4001	

K-KIT	SK-KIT	CL-KIT	LIFTERS	DIST. GEAR	TIMING SET	ROCKER ARMS	PUSHRODS	VALVE SPRINGS	RETAINERS	VALVE LOCKS	VALVE SEALS
MAGNUM Retro-Fit Hydraulic Roller Camshafts											
K12-410-8	SK12-410-8 ^{7,10}	CL12-410-8 ^{7,10}	853-16 15853-16	412M	2100 7100	1412-16 ^{15,52} 1601-16 ^{15,52}	7809-16 7609-16	986-16 ² 26986-16 ²	740-16 795-16	611-16 614-16	503-16 ²
K12-420-8	SK12-420-8 ^{7,10}	CL12-420-8 ^{7,10}	853-16 15853-16	412M	2100 7100	1412-16 ^{15,52} 1601-16 ^{15,52}	7809-16 7609-16	986-16 ² 26986-16 ²	740-16 795-16	611-16 614-16	503-16 ²
K12-430-8	SK12-430-8 ^{7,10}	CL12-430-8 ^{7,10}	853-16 15853-16	412M	2100 7100	1412-16 ^{15,52} 1601-16 ^{15,52}	7809-16 7609-16	986-16 ² 26986-16 ²	740-16 795-16	611-16 614-16	503-16 ²
K12-450-8	SK12-450-8 ^{7,10}	CL12-450-8 ^{7,10}	853-16 15853-16	412M	2100 7100	1412-16 ^{15,52} 1601-16 ^{15,52}	7809-16 7609-16	987-16 ² 26986-16 ²	740-16 795-16	611-16 614-16	503-16 ²
K12-460-8	SK12-460-8 ^{7,10}	CL12-460-8 ^{7,10}	853-16 15853-16	412M	2100 7100	1412-16 ^{15,52} 1601-16 ^{15,52}	7809-16 7609-16	950-16 ² 26986-16 ²	740-16 795-16	611-16 614-16	503-16 ²
K12-470-8	SK12-470-8 ^{7,10}	CL12-470-8 ^{7,10}	853-16 15853-16	412M	2100 7100	1412-16 ^{15,52} 1601-16 ^{15,52}	7809-16 7609-16	950-16 ² 26986-16 ²	740-16 795-16	611-16 614-16	503-16 ²

XTREME ENERGY™ Retro-Fit Hydraulic Roller Camshafts											
K12-407-8	SK12-407-8 ^{7,10}	CL12-407-8 ^{7,10}	853-16 15853-16	412M	2100 7100	1412-16 ^{15,52} 1601-16 ^{15,52}	7809-16 7609-16	981-16 26981-16	742-16 787-16	601-16 648-16	501-16 503-16 ²
K12-408-8	SK12-408-8 ^{7,10}	CL12-408-8 ^{7,10}	853-16 15853-16	412M	2100 7100	1412-16 ^{15,52} 1601-16 ^{15,52}	7809-16 7609-16	981-16 26981-16	742-16 787-16	601-16 648-16	501-16 503-16 ²
K12-412-8	SK12-412-8 ^{7,10}	CL12-412-8 ^{7,10}	853-16 15853-16	412M	2100 7100	1412-16 ^{15,52} 1601-16 ^{15,52}	7809-16 7609-16	986-16 ² 26986-16 ²	740-16 795-16	611-16 614-16	503-16 ²
K12-422-8	SK12-422-8 ^{7,10}	CL12-422-8 ^{7,10}	853-16 15853-16	412M	2100 7100	1412-16 ^{15,52} 1601-16 ^{15,52}	7809-16 7609-16	986-16 ² 26986-16 ²	740-16 795-16	611-16 614-16	503-16 ²
K12-423-8	SK12-423-8 ^{7,10}	CL12-423-8 ^{7,10}	853-16 15853-16	412M	2100 7100	1412-16 ^{15,52} 1601-16 ^{15,52}	7809-16 7609-16	986-16 ² 26986-16 ²	740-16 795-16	611-16 614-16	503-16 ²

⁴⁶ Must use bronze tip fuel pump pushrod when using high pressure or high volume pump

⁴⁸ Includes 3 cam bolts, thrust bearing, adjustable cam timing system, 2 machined steel gears & true roller chain

⁵² Engines with self-aligning rocker arms must use Part #1417-16 or #1617-16



CHEVROLET 262-400 C.I. 8 CYL. 1958-1998 (CONTINUED)

APPLICATIONS/CAMSHAFTS	VALVE SETTING		RPM OPERATING RANGE	CAM PART #	CAM GRIND #	DURATION				VALVE LIFT		LOBE SEP. ANGLE
	IN.	EX.				ADVERTISED IN.	EX.	@ .050" IN.	EX.	W/ 1.5 ROCKER IN.	EX.	
XTREME ENERGY™ Retro-Fit Hydraulic Roller Camshafts (CONTINUED)												
HYDRAULIC ROLLER – Great for street machines, needs intake, headers, 2500+ stall, and gears. Mildly rough idle.	Hyd.	Hyd.	2200 to 5800	12-432-8 ^{10,46}	XR282HR	282	288	230	236	.510	.520	110°
HYDRAULIC ROLLER – Street/strip applications, 9:1 compression, rough idle intake, headers, 2800+ stall, gears.	Hyd.	Hyd.	2500 to 6000	12-433-8 ^{10,46}	XR288HR	288	294	236	242	.520	.540	110°
HYDRAULIC ROLLER – Street/strip applications, 9.5:1 compression, intake, headers, 3000+ stall, gears. Rough idle.	Hyd.	Hyd.	2800 to 6100	12-443-8 ^{10,46}	XR294HR	294	300	242	248	.540	.562	110°
HYDRAULIC ROLLER – Pro Street/bracket racing, 10:1 compression, 3500+ stall, good intake, headers. Very rough idle.	Hyd.	Hyd.	3200 to 6200	12-444-8 ^{10,46}	XR300HR	300	306	248	254	.562	.580	110°
THUMPR™ Retro-Fit Hydraulic Roller Camshafts												
HYDRAULIC ROLLER – Thumpr™ – High performance street, stock converter ok, best with 2000+ converter and gears, choppy/thumping idle.	Hyd.	Hyd.	1900 to 5600	12-600-8 ^{10,46}	283THR7	283	303	227	241	.513	.498	107°
HYDRAULIC ROLLER – Mutha' Thumpr™ – High performance street/strip, needs 9:1 compression, 2500+ stall, intake, gears and headers, rough idle.	Hyd.	Hyd.	2200 to 5900	12-601-8 ^{10,46}	291THR7	291	311	235	249	.522	.509	107°
HYDRAULIC ROLLER – Big Mutha' Thumpr™ – Street/strip, needs 9.5:1 compression, 2800+ stall, intake, gears and headers, very rough idle.	Hyd.	Hyd.	2500 to 6200	12-602-8 ^{10,46}	299THR7	299	319	243	257	.533	.519	107°
XTREME 4X4™ Retro-Fit Hydraulic Roller Camshafts												
HYDRAULIC ROLLER – Strong torque, good mileage, for stock to mildly modified engines.	Hyd.	Hyd.	1000 to 5000	12-409-8 ^{10,46}	X4258HR	258	262	206	210	.458	.458	111°
HYDRAULIC ROLLER – Good mid-range power, good performance increase. Largest with stock converter.	Hyd.	Hyd.	1200 to 5200	12-411-8 ^{10,46}	X4260HR	260	264	210	214	.474	.474	111°
HYDRAULIC ROLLER – Good mid-range power, needs headers, 3.55-4.10 gears, 2000+ stall. Noticeable idle.	Hyd.	Hyd.	1500 to 5500	12-413-8 ^{10,46}	X4270HR	270	274	220	224	.474	.474	111°
HYDRAULIC ROLLER – Strong mid-range power, needs headers, 3.73-4.10 gears, 2500+ stall, rough idle.	Hyd.	Hyd.	1800 to 5800	12-414-8 ^{10,46}	X4280HR	280	284	230	234	.474	.474	111°
XTREME MARINE™ Retro-Fit Hydraulic Roller Camshafts												
HYDRAULIC ROLLER – Good for inboard/outboard pleasure boat, skiing and good economy.	Hyd.	Hyd.	1200 to 5200	12-416-8 ^{10,46}	XM264HR	264	270	212	218	.488	.495	112°
HYDRAULIC ROLLER – Largest for inboard/outboard, good mid-range w/ excellent response, noticeable idle.	Hyd.	Hyd.	1500 to 5500	12-417-8 ^{10,46}	XM270HR	270	276	218	224	.495	.503	112°
HYDRAULIC ROLLER – Good for jet with A impeller, strong mid-range power, needs good exhaust.	Hyd.	Hyd.	1800 to 5800	12-418-8 ^{10,46}	XM276HR	276	282	224	230	.503	.510	112°

² Requires machining on cylinder heads

⁷ Stock springs cannot be used

¹⁰ Requires thrust button & wear plate

¹⁵ 50-State legal on 1993 & earlier SB Chevrolet V8, 262-400c.i. C.A.R.B. E.O. #D-279-4

⁴⁶ Must use bronze tip fuel pump pushrod when using high pressure or high volume pump

CHEVROLET 262-400 C.I. 8 CYL. 1958-1998 (CONTINUED)

CAMSHAFTS GENERAL MOTORS

K-KIT	SK-KIT	CL-KIT	LIFTERS	DIST. GEAR	TIMING SET	ROCKER ARMS	PUSHRODS	VALVE SPRINGS	RETAINERS	VALVE LOCKS	VALVE SEALS
XTREME ENERGY™ Retro-Fit Hydraulic Roller Camshafts (CONTINUED)											
K12-432-8	SK12-432-8 ^{7,10}	CL12-432-8 ^{7,10}	853-16 15853-16	412M	2100 7100	1412-16 ^{15,52} 1601-16 ^{15,52}	7809-16 7609-16	986-16 ² 26986-16 ²	740-16 795-16	611-16 614-16	503-16 ²
K12-433-8	SK12-433-8 ^{7,10}	CL12-433-8 ^{7,10}	853-16 15853-16	412M	2100 7100	1412-16 ^{15,52} 1601-16 ^{15,52}	7809-16 7609-16	986-16 ² 26986-16 ²	740-16 795-16	611-16 614-16	503-16 ²
K12-443-8	SK12-443-8 ^{7,10}	CL12-443-8 ^{7,10}	853-16 15853-16	412M	2100 7100	1412-16 ^{15,52} 1601-16 ^{15,52}	7809-16 7609-16	987-16 ² 26986-16 ²	740-16 795-16	611-16 614-16	503-16 ²
K12-444-8	SK12-444-8 ^{7,10}	CL12-444-8 ^{7,10}	853-16 15853-16	412M	2100 7100	1412-16 ^{15,52} 1601-16 ^{15,52}	7809-16 7609-16	987-16 ² 26986-16 ²	740-16 795-16	611-16 614-16	503-16 ²
THUMPR™ Retro-Fit Hydraulic Roller Camshafts											
K12-600-8	GK12-600-8 ^{7,93}	CL12-600-8 ⁷	853-16 15853-16	2100 3100	4100	1412-16 ^{15,52} 1601-16 ^{15,52}	7609-16 7940-16	26981-16 26918-16	787-16	648-16	501-16
K12-601-8	GK12-601-8 ^{7,93}	CL12-601-8 ⁷	853-16 15853-16	2100 3100	4100	1412-16 ^{15,52} 1601-16 ^{15,52}	7609-16 7940-16	26918-16 26986-16 ²	787-16 795-16	648-16 611-16	501-16
K12-602-8	GK12-602-8 ^{7,93}	CL12-602-8 ⁷	853-16 15853-16	2100 3100	4100	1412-16 ^{15,52} 1601-16 ^{15,52}	7609-16 7940-16	26918-16 26986-16 ²	787-16 795-16	648-16 611-16	501-16
XTREME 4X4™ Retro-Fit Hydraulic Roller Camshafts											
K12-409-8	SK12-409-8 ^{7,10}	CL12-409-8 ^{7,10}	853-16 15853-16	412M	2100 7100	1412-16 ^{15,52} 1601-16 ^{15,52}	7809-16 7609-16	981-16 26981-16	742-16 787-16	601-16 648-16	501-16 503-16 ²
K12-411-8	SK12-411-8 ^{7,10}	CL12-411-8 ^{7,10}	853-16 15853-16	412M	2100 7100	1412-16 ^{15,52} 1601-16 ^{15,52}	7809-16 7609-16	981-16 26981-16	742-16 787-16	601-16 648-16	501-16 503-16 ²
K12-413-8	SK12-413-8 ^{7,10}	CL12-413-8 ^{7,10}	853-16 15853-16	412M	2100 7100	1412-16 ^{15,52} 1601-16 ^{15,52}	7809-16 7609-16	981-16 26981-16	742-16 787-16	601-16 648-16	501-16 503-16 ²
K12-414-8	SK12-414-8 ^{7,10}	CL12-414-8 ^{7,10}	853-16 15853-16	412M	2100 7100	1412-16 ^{15,52} 1601-16 ^{15,52}	7809-16 7609-16	981-16 26981-16	742-16 787-16	601-16 648-16	501-16 503-16 ²
XTREME MARINE™ Retro-Fit Hydraulic Roller Camshafts											
K12-416-8	SK12-416-8 ^{7,10}	CL12-416-8 ^{7,10}	853-16 15853-16	412M	2100 7100	1412-16 ^{15,52} 1601-16 ^{15,52}	7809-16 7609-16	986-16 ² 26986-16 ²	740-16 795-16	611-16 614-16	503-16 ²
K12-417-8	SK12-417-8 ^{7,10}	CL12-417-8 ^{7,10}	853-16 15853-16	412M	2100 7100	1412-16 ^{15,52} 1601-16 ^{15,52}	7809-16 7609-16	986-16 ² 26986-16 ²	740-16 795-16	611-16 614-16	503-16 ²
K12-418-8	SK12-418-8 ^{7,10}	CL12-418-8 ^{7,10}	853-16 15853-16	412M	2100 7100	1412-16 ^{15,52} 1601-16 ^{15,52}	7809-16 7609-16	986-16 ² 26986-16 ²	740-16 795-16	611-16 614-16	503-16 ²

⁵² Engines with self-aligning rocker arms must use Part #1417-16 or #1617-16

⁹³ GK-Kit contains cam, lifters & gear drive

RED NUMBERS DENOTE PREMIUM OPTION



CHEVROLET 262-400 C.I. 8 CYL. 1958-1998 (CONTINUED)

APPLICATIONS/CAMSHAFTS	VALVE SETTING		RPM OPERATING RANGE	CAM PART #	CAM GRIND #	DURATION				VALVE LIFT		LOBE SEP. ANGLE
	IN.	EX.				ADVERTISED IN.	EX.	@ .050" IN.	EX.	W/ 1.5 ROCKER IN.	EX.	
NITROUS HP™ Retro-Fit Hydraulic Roller Camshafts												
HYDRAULIC ROLLER – Street machine with 125+ nitrous system or small supercharger. 2200+ Stall with lower gears.	Hyd.	Hyd.	2000 to 6000	12-415-8 ^{10,46}	NX276HR	276	288	224	236	.502	.520	113°
HYDRAULIC ROLLER – 175+ nitrous system. 2500+ Stall with lower gears and headers.	Hyd.	Hyd.	2400 to 6500	12-419-8 ^{10,46}	NX288HR	288	315	236	248	.520	.540	113°
XTREME FUEL INJECTION (XFI™) Retro-Fit Hydraulic Roller Camshafts (WITH 1.6 ROCKERS)												
HYDRAULIC ROLLER – Good for 305 or 350 TBI. Excellent off idle performance. Xtreme torque.	Hyd.	Hyd.	1000 to 5000	12-464-8 ^{10,46}	252XFI HR13	252	264	202	212	.550	.546	113°
HYDRAULIC ROLLER – Good low end and mid-range cam. Exhaust upgrade preferred. Smooth torque curve.	Hyd.	Hyd.	1200 to 5200	12-465-8 ^{10,46}	260XFI HR13	260	270	210	218	.560	.555	113°
HYDRAULIC ROLLER – Ample low end with very good mid-range. Gear and exhaust upgrade needed. Largest cam for stock converter.	Hyd.	Hyd.	1800 to 5800	12-466-8 ^{10,46}	268XFI HR13	268	276	218	224	.570	.565	113°
HYDRAULIC ROLLER – Great for "Hot Street". Must upgrade intake gear and exhaust for maximum performance. 2500+ Stall.	Hyd.	Hyd.	2000 to 5000	12-467-8 ^{10,46}	280XFI HR13	280	288	230	236	.576	.570	113°
HYDRAULIC ROLLER – Street/strip. Best at wide-open throttle. Need all upgrades with 2600+ converter. 9.5:1 compression.	Hyd.	Hyd.	2200 to 6200	12-468-8 ^{10,46}	292XFI HR13	292	300	242	248	.584	.579	113°

APPLICATIONS/CAMSHAFTS	VALVE SETTING		RPM OPERATING RANGE	CAM PART #	CAM GRIND #	DURATION				VALVE LIFT		LOBE SEP. ANGLE
	IN.	EX.				ADVERTISED IN.	EX.	@ .050" IN.	EX.	W/ 1.6 ROCKER IN.	EX.	
4-PATTERN Retro-Fit Hydraulic Roller Camshafts (WITH 1.6 ROCKERS)												
(Larger cam lobes for outboard cylinders)												
HYDRAULIC ROLLER – Best choice for smaller c.i. applications with very good heads. Extremely wide power range. 1800+ Stall.	Hyd.	Hyd.	1700-6300	12-471-44	269Q108	271 OB	283 OB	219 OB	229 OB	.603 OB	.590 OB	108.5 OB
						269 IB	281 IB	217 IB	227 IB	.600 IB	.587 IB	107.5 IB
HYDRAULIC ROLLER – Great all around choice for street applications in modified engines and 2500+ stall or manual transmissions	Hyd.	Hyd.	2300-6600	12-472-44	281Q108	283 OB	295 OB	231 OB	241 OB	.622 OB	.610 OB	108.5 OB
						281 IB	293 IB	229 IB	239 IB	.619 IB	.606 IB	107.5 IB
HYDRAULIC ROLLER – Excellent for street/strip applications with good heads and raised compression in high RPM engines. 3200+ Stall.	Hyd.	Hyd.	2900-7200	12-474-44	293Q108	295 OB	307 OB	243 OB	253 OB	.638 OB	.622 OB	108.5 OB
						293 IB	305 IB	241 IB	251 IB	.637 IB	.622 IB	107.5 IB
HYDRAULIC ROLLER – Recommended in larger c.i. and high compression applications. 3500+ Stall.	Hyd.	Hyd.	3300-7500	12-476-44	305Q108	307 OB	319 OB	255 OB	265 OB	.638 OB	.622 OB	108.5 OB
						305 IB	317 IB	253 IB	263 IB	.638 IB	.622 IB	107.5 IB

4-PATTERN Small Base Circle (.900") Retro-Fit Hydraulic Roller Camshafts (WITH 1.6 ROCKERS)												
(Larger cam lobes for outboard cylinders)												
HYDRAULIC ROLLER – Best choice for street 383 stroker engines with good cylinder heads. Very wide power range. 2600+ Stall.	Hyd.	Hyd.	2400-6700	12-473-44	287Q59	289 OB	301 OB	236 OB	246 OB	.630 OB	.618 OB	109.5 OB
						287 IB	299 IB	234 IB	244 IB	.627 IB	.614 IB	108.5 IB
HYDRAULIC ROLLER – Great in larger c.i. street to street/strip stroker small blocks w/ good heads.	Hyd.	Hyd.	2900-7200	12-475-44	299Q510	301 OB	313 OB	248 OB	258 OB	.637 OB	.621 OB	110.5 OB
						299 IB	311 IB	246 IB	256 IB	.637 IB	.621 IB	109.5 IB
HYDRAULIC ROLLER – Recommended in highly modified 420+ c.i. stroker applications with higher compression. 3500+ Stall.	Hyd.	Hyd.	3200-7500	12-477-44	311Q510	313 OB	325 OB	260 OB	270 OB	.637 OB	.621 OB	110.5 OB
						311 IB	323 IB	258 IB	268 IB	.637 IB	.621 IB	109.5 IB

² Requires machining on cylinder heads
⁷ Stock springs cannot be used

¹⁰ Requires thrust button & wear plate

⁴⁶ Must use bronze tip fuel pump pushrod when using high pressure or high volume pump

CHEVROLET 262-400 C.I. 8 CYL. 1958-1998 (CONTINUED)

CAMSHAFTS GENERAL MOTORS

K-KIT	SK-KIT	CL-KIT	LIFTERS	DIST. GEAR	TIMING SET	ROCKER ARMS	PUSHRODS	VALVE SPRINGS	RETAINERS	VALVE LOCKS	VALVE SEALS
NITROUS HP™ Retro-Fit Hydraulic Roller Camshafts											
K12-415-8	SK12-415-8 ^{7,10}	CL12-415-8 ^{7,10}	853-16 15853-16	412M	2100 7100	1412-16 ^{15,52} 1601-16 ^{15,52}	7809-16 7609-16	986-16 ² 26986-16 ²	740-16 795-16	611-16 614-16	503-16 ²
K12-419-8	SK12-419-8 ^{7,10}	CL12-419-8 ^{7,10}	853-16 15853-16	412M	2100 7100	1412-16 ^{15,52} 1601-16 ^{15,52}	7809-16 7609-16	986-16 ² 26986-16 ²	740-16 795-16	611-16 614-16	503-16 ²
XTREME FUEL INJECTION (XFI™) Retro-Fit Hydraulic Roller Camshafts (WITH 1.6 ROCKERS)											
K12-464-8	SK12-464-8 ^{7,10}	CL12-464-8 ^{7,10}	853-16 15853-16	412M	2100 7100	1416-16 ⁷⁷ 1602-16 ⁷⁷	7809-16 7609-16	26986-16 ²	787-16 1787-16	601-16 648-16	501-16 503-16 ²
K12-465-8	SK12-465-8 ^{7,10}	CL12-465-8 ^{7,10}	853-16 15853-16	412M	2100 7100	1416-16 ⁷⁷ 1602-16 ⁷⁷	7809-16 7609-16	26986-16 ²	787-16 1787-16	601-16 648-16	501-16 503-16 ²
K12-466-8	SK12-466-8 ^{7,10}	CL12-466-8 ^{7,10}	853-16 15853-16	412M	2100 7100	1416-16 ⁷⁷ 1602-16 ⁷⁷	7809-16 7609-16	26986-16 ²	787-16 1787-16	601-16 648-16	501-16 503-16 ²
K12-467-8	SK12-467-8 ^{7,10}	CL12-467-8 ^{7,10}	853-16 15853-16	412M	2100 7100	1416-16 ⁷⁷ 1602-16 ⁷⁷	7809-16 7609-16	26986-16 ²	787-16 1787-16	601-16 648-16	501-16 503-16 ²
K12-468-8	SK12-468-8 ^{7,10}	CL12-468-8 ^{7,10}	853-16 15853-16	412M	2100 7100	1416-16 ⁷⁷ 1602-16 ⁷⁷	7809-16 7609-16	26986-16 ²	787-16 1787-16	601-16 648-16	501-16 503-16 ²

LIFTERS	TIMING SET	ROCKER ARMS	PUSHRODS	VALVE SPRINGS	RETAINERS	VALVE LOCKS	VALVE SEALS	LASH CAPS	REV KIT	DIST. GEAR	STUD GIRDLES
4-PATTERN Retro-Fit Hydraulic Roller Camshafts (WITH 1.6 ROCKERS)											
15853-16	7100 8100	1602-16 1802-16	7609-16 7949-16	26926-16	1777-16	648-16	518-16	622-16	N/A	412M	4001
15853-16	7100 8100	1602-16 1802-16	7609-16 7949-16	26926-16	1777-16	648-16	518-16	622-16	N/A	412M	4001
15853-16	7100 8100	1602-16 1802-16	7609-16 7949-16	26926-16	1777-16	648-16	518-16	622-16	N/A	412M	4001
15853-16	7100 8100	1602-16 1802-16	7609-16 7949-16	26926-16	1777-16	648-16	518-16	622-16	N/A	412M	4001

4-PATTERN Small Base Circle (.900") Retro-Fit Hydraulic Roller Camshafts (WITH 1.6 ROCKERS)											
15853-16	7100 8100	1602-16 1802-16	7609-16 7949-16	26926-16	1777-16	648-16	518-16	622-16	N/A	412M	4001
15853-16	7100 8100	1602-16 1802-16	7609-16 7949-16	26926-16	1777-16	648-16	518-16	622-16	N/A	412M	4001
15853-16	7100 8100	1602-16 1802-16	7609-16 7949-16	26926-16	1777-16	648-16	518-16	622-16	N/A	412M	4001

⁷⁷ Engines with self-aligning rocker arms must use Part #1418-16 or #1618-16

RED NUMBERS DENOTE PREMIUM OPTION



CHEVROLET 262-400 C.I. 8 CYL. 1958-1998 (CONTINUED)

APPLICATIONS/CAMSHAFTS	VALVE SETTING		RPM OPERATING RANGE	CAM PART #	CAM GRIND #	DURATION				VALVE LIFT		LOBE SEP. ANGLE
	IN.	EX.				IN.	EX.	IN.	EX.	IN.	EX.	
DRAG RACE Retro-Fit Hydraulic Roller Camshafts												
HYDRAULIC ROLLER – Good 1/8 mile bracket race cam. Needs 10:1+ compression and 3500+ stall	Hyd.	Hyd.	3500-6500	12-870-11	301QNHR-6	301	311	248	256	.597	.582	106°
HYDRAULIC ROLLER – Strong top end in 350+ c.i. engines. Best w/ 11:1+ compression and better heads	Hyd.	Hyd.	3800-6800	12-871-11	313QNHR-8	313	325	260	270	.597	.582	108°
HYDRAULIC ROLLER – Best in larger c.i. engines. Needs 11.5:1+ compression and 4500 stall.	Hyd.	Hyd.	4200-7200	12-872-11	321QNHR-8	321	329	267	275	.600	.600	108°

APPLICATIONS/CAMSHAFTS	VALVE SETTING		RPM OPERATING RANGE	CAM PART #	CAM GRIND #	DURATION				VALVE LIFT		LOBE SEP. ANGLE
	IN.	EX.				IN.	EX.	IN.	EX.	IN.	EX.	
MAGNUM Hydraulic Roller Camshafts (CARBURETED)												
1987-98 305-350 Engines With O.E. Hyd. Roller Cams (EXCEPT LT1 & LT4)												
HYDRAULIC ROLLER – Excellent mileage, smooth idle. Works with pickups, vans and towing. Stock gear ratios and converter.	Hyd.	Hyd.	1200 to 4500	08-410-8⁴⁶	260HR	260	260	206	206	.500	.500	110°
HYDRAULIC ROLLER – Mild street performance, slightly noticeable idle. Needs aftermarket intake, headers, 3.40-4.10 gears.	Hyd.	Hyd.	1800 to 5000	08-420-8⁴⁶	270HR	270	270	215	215	.500	.500	110°
HYDRAULIC ROLLER – High performance street use. Aftermarket intake, headers and 2000+ stall, 3.40 to 4.10 gears. Mild rough idle.	Hyd.	Hyd.	2000 to 5500	08-430-8⁴⁶	280HR	280	280	224	224	.525	.525	110°
HYDRAULIC ROLLER – Great for street machines. Best with headers and aluminum intake. 2500+ stall. Rough idle.	Hyd.	Hyd.	2500 to 6000	08-450-8⁴⁶	286HR	286	286	230	230	.560	.560	110°
HYDRAULIC ROLLER – Street/strip applications. 3000+ stall. Use 4.10 gears, aftermarket intake and headers. Very rough idle.	Hyd.	Hyd.	3000 to 6500	08-460-8⁴⁶	304HR	304	304	244	244	.600	.600	110°
HYDRAULIC ROLLER – Limited street/ bracket racing. 10.5:1. 3500+ stall. Headers and race intake.	Hyd.	Hyd.	3500 to 6500	08-470-8⁴⁶	314HR	314	314	252	252	.600	.600	110°

XTREME ENERGY™ Hydraulic Roller Camshafts (CARBURETED)												
1987-98 305-350 Engines With O.E. Hyd. Roller Cams (EXCEPT LT1 & LT4)												
HYDRAULIC ROLLER – Good for towing, excellent mileage, smooth idle. Will work with stock converters and gears.	Hyd.	Hyd.	600 to 4600	08-407-8⁴⁶	XR252HR	252	258	200	206	.472	.480	110°
HYDRAULIC ROLLER – Strong torque, good mileage, stock to mildly modified combinations.	Hyd.	Hyd.	1000 to 5000	08-408-8⁴⁶	XR258HR	258	264	206	212	.480	.487	110°
HYDRAULIC ROLLER – Mild performance applications, good mid-range, 3.23-3.73 gears. Slightly noticeable idle.	Hyd.	Hyd.	1200 to 5200	08-412-8⁴⁶	XR264HR	264	270	212	218	.487	.495	110°
HYDRAULIC ROLLER – High performance application, largest with stock converter, noticeable idle.	Hyd.	Hyd.	1600 to 5400	08-422-8⁴⁶	XR270HR	270	276	218	224	.495	.502	110°
HYDRAULIC ROLLER – High performance street machines, 2000+ stall, gears, choppy idle.	Hyd.	Hyd.	1900 to 5600	08-423-8⁴⁶	XR276HR	276	282	224	230	.502	.510	110°
HYDRAULIC ROLLER – Great for street machines, needs intake, headers, stall and gears. 2500+ stall.	Hyd.	Hyd.	2200 to 5800	08-432-8⁴⁶	XR282HR	282	288	230	236	.510	.520	110°

² Requires machining on cylinder heads

⁷ Stock springs cannot be used

¹¹ Lifters only, does not include lifter retainers or guides

CHEVROLET 262-400 C.I. 8 CYL. 1958-1998 (CONTINUED)

CAMSHAFTS GENERAL MOTORS

LIFTERS	TIMING	ROCKERS	PUSHRODS	VALVE SPRINGS	RETAINERS	VALVE LOCKS	VALVE SEALS	LASH CAPS	REV KIT	DIST. GEAR	STUD GIRDLES
DRAG RACE Retro-Fit Hydraulic Roller Camshafts											
15853-16	7100 8100	1604-16 1804-16	7609-16 7949-16	977-16 ² 26055-16	1730-16 785-16	648-16	518-16	622-16	N/A	412M	4001
15853-16	7100 8100	1604-16 1804-16	7609-16 7949-16	977-16 ² 26055-16	1730-16 785-16	648-16	518-16	622-16	N/A	412M	4001
15853-16	7100 8100	1604-16 1804-16	7609-16 7949-16	977-16 ² 26055-16	1730-16 785-16	648-16	518-16	622-16	N/A	412M	4001

K-KIT	SK-KIT	CL-KIT	LIFTERS	DIST. GEAR	TIMING SET	ROCKER ARMS	PUSHRODS	VALVE SPRINGS	RETAINERS	VALVE LOCKS	VALVE SEALS
MAGNUM Hydraulic Roller Camshafts (CARBURETED)											
K08-410-8	SK08-410-8 ⁷	CL08-410-8 ⁷	850-16 ¹¹ 875-16 ¹¹	412M	2136 3136	1417-16 ¹⁵ 1617-16 ¹⁵	7808-16 7608-16	986-16 ² 26986-16 ²	740-16 795-16	611-16 614-16	503-16 ²
K08-420-8	SK08-420-8 ⁷	CL08-420-8 ⁷	850-16 ¹¹ 875-16 ¹¹	412M	2136 3136	1417-16 ¹⁵ 1617-16 ¹⁵	7808-16 7608-16	986-16 ² 26986-16 ²	740-16 795-16	611-16 614-16	503-16 ²
K08-430-8	SK08-430-8 ⁷	CL08-430-8 ⁷	850-16 ¹¹ 875-16 ¹¹	412M	2136 3136	1417-16 ¹⁵ 1617-16 ¹⁵	7808-16 7608-16	986-16 ² 26986-16 ²	740-16 795-16	611-16 614-16	503-16 ²
K08-450-8	SK08-450-8 ⁷	CL08-450-8 ⁷	850-16 ¹¹ 875-16 ¹¹	412M	2136 3136	1417-16 ¹⁵ 1617-16 ¹⁵	7808-16 7608-16	986-16 ² 26986-16 ²	740-16 795-16	611-16 614-16	503-16 ²
K08-460-8	SK08-460-8 ⁷	CL08-460-8 ⁷	850-16 ¹¹ 15850-16	412M	2136 3136	1417-16 ¹⁵ 1617-16 ¹⁵	7808-16 7608-16	986-16 ² 26986-16 ²	740-16 795-16	611-16 614-16	503-16 ²
K08-470-8	SK08-470-8 ⁷	CL08-470-8 ⁷	850-16 ¹¹ 15850-16	412M	2136 3136	1417-16 ¹⁵ 1617-16 ¹⁵	7808-16 7608-16	986-16 ² 26986-16 ²	740-16 795-16	611-16 614-16	503-16 ²

XTREME ENERGY™ Hydraulic Roller Camshafts (CARBURETED)											
K08-407-8	SK08-407-8 ⁷	CL08-407-8 ⁷	850-16 ¹¹ 875-16 ¹¹	412M	2136 3136	1417-16 ¹⁵ 1617-16 ¹⁵	7808-16 7608-16	981-16 26981-16	742-16 787-16	601-16 648-16	501-16 503-16 ²
K08-408-8	SK08-408-8 ⁷	CL08-408-8 ⁷	850-16 ¹¹ 875-16 ¹¹	412M	2136 3136	1417-16 ¹⁵ 1617-16 ¹⁵	7808-16 7608-16	981-16 26981-16	742-16 787-16	601-16 648-16	501-16 503-16 ²
K08-412-8	SK08-412-8 ⁷	CL08-412-8 ⁷	850-16 ¹¹ 875-16 ¹¹	412M	2136 3136	1417-16 ¹⁵ 1617-16 ¹⁵	7808-16 7608-16	986-16 ² 26986-16 ²	740-16 795-16	611-16 614-16	503-16 ²
K08-422-8	SK08-422-8 ⁷	CL08-422-8 ⁷	850-16 ¹¹ 875-16 ¹¹	412M	2136 3136	1417-16 ¹⁵ 1617-16 ¹⁵	7808-16 7608-16	986-16 ² 26986-16 ²	740-16 795-16	611-16 614-16	503-16 ²
K08-423-8	SK08-423-8 ⁷	CL08-423-8 ⁷	850-16 ¹¹ 875-16 ¹¹	412M	2136 3136	1417-16 ¹⁵ 1617-16 ¹⁵	7808-16 7608-16	986-16 ² 26986-16 ²	740-16 795-16	611-16 614-16	503-16 ²
K08-432-8	SK08-432-8 ⁷	CL08-432-8 ⁷	850-16 ¹¹ 875-16 ¹¹	412M	2136 3136	1417-16 ¹⁵ 1617-16 ¹⁵	7808-16 7608-16	986-16 ² 26986-16 ²	740-16 795-16	611-16 614-16	503-16 ²

¹⁵ 50-State legal on 1993 & earlier SB Chevrolet V8, 262-400c.i. C.A.R.B. E.O. #D-279-4

⁴⁶ Must use bronze tip fuel pump pushrod when using high pressure or high volume pump

RED NUMBERS DENOTE PREMIUM OPTION



CHEVROLET 262-400 C.I. 8 CYL. 1958-1998 (CONTINUED)

APPLICATIONS/CAMSHAFTS	VALVE SETTING		RPM OPERATING RANGE	CAM PART #	CAM GRIND #	DURATION				VALVE LIFT		LOBE SEP. ANGLE
	IN.	EX.				ADVERTISED IN.	EX.	@ .050" IN.	EX.	W/ 1.5 ROCKER IN.	EX.	

XTREME ENERGY™ Hydraulic Roller Camshafts (CARBURETED) (CONTINUED)

1987-98 305-350 Engines With O.E. Hyd. Roller Cams (EXCEPT LT1 & LT4)

HYDRAULIC ROLLER – Street/strip applications, 9:1+ compression, intake, headers, gears. 3000+ stall. Rough idle.	Hyd.	Hyd.	2500 to 6000	08-433-8⁴⁶	XR288HR	288	294	236	242	.520	.540	110°
HYDRAULIC ROLLER – Street/strip applications, 9.5:1+ compression, intake, headers, stall, gears. 3200+ stall.	Hyd.	Hyd.	2800 to 6100	08-443-8⁴⁶	XR294HR	294	300	242	248	.540	.562	110°
HYDRAULIC ROLLER – Pro Street, bracket racing, 10:1+ compression, 3500+ stall, good intake, headers.	Hyd.	Hyd.	3200 to 6200	08-444-8⁴⁶	XR300HR	300	306	248	254	.562	.580	110°

APPLICATIONS/CAMSHAFTS	VALVE SETTING		RPM OPERATING RANGE	CAM PART #	CAM GRIND #	DURATION				VALVE LIFT		LOBE SEP. ANGLE
	IN.	EX.				ADVERTISED IN.	EX.	@ .050" IN.	EX.	W/ 1.5 ROCKER IN.	EX.	

THUMPR™ Retro-Fit Hydraulic Roller Camshafts (CARBURETED)

1987-98 305-350 Engines With O.E. Hyd. Roller Cams (EXCEPT LT1 & LT4)

HYDRAULIC ROLLER – Thumpr™ – High performance street, stock converter ok, best with 2000+ converter and gears, choppy/thumping idle.	Hyd.	Hyd.	1900 to 5600	08-600-8⁴⁶	283THR7	283	303	227	241	.513	.498	107°
HYDRAULIC ROLLER – Mutha' Thumpr™ – High performance street/strip, needs 9:1 compression, 2500+ stall, intake, gears and headers, rough idle.	Hyd.	Hyd.	2200 to 5900	08-601-8⁴⁶	291THR7	291	311	235	249	.522	.509	107°
HYDRAULIC ROLLER – Big Mutha' Thumpr™ – Street/strip, needs 9.5:1 compression, 2800+ stall, intake, gears and headers, very rough idle.	Hyd.	Hyd.	2500 to 6200	08-602-8⁴⁶	299THR7	299	319	243	257	.533	.519	107°

APPLICATIONS/CAMSHAFTS	VALVE SETTING		RPM OPERATING RANGE	CAM PART #	CAM GRIND #	DURATION				VALVE LIFT		LOBE SEP. ANGLE
	IN.	EX.				ADVERTISED IN.	EX.	@ .050" IN.	EX.	W/ 1.5 ROCKER IN.	EX.	

XTREME 4X4™ Hydraulic Roller Camshafts (CARBURETED)

1987-98 305-350 Engines With O.E. Hyd. Roller Cams (EXCEPT LT1 & LT4)

HYDRAULIC ROLLER – Strong torque, good mileage, for stock to mildly modified engines.	Hyd.	Hyd.	1000 to 5000	08-409-8⁴⁶	X4258HR	258	262	206	210	.458	.458	111°
HYDRAULIC ROLLER – Good mid-range power, good with 3.23-3.73 gear.	Hyd.	Hyd.	1200 to 5200	08-411-8⁴⁶	X4260HR	260	264	210	214	.474	.474	111°
HYDRAULIC ROLLER – Good mid-range power, needs headers, 3.55-4.10 gears, 2000 stall. Noticeable idle.	Hyd.	Hyd.	1500 to 5500	08-413-8⁴⁶	X4270HR	270	274	220	224	.474	.474	111°
HYDRAULIC ROLLER – Good top end. Needs headers, lower gears and 2500+ stall.	Hyd.	Hyd.	1800 to 5800	08-414-8⁴⁶	X4280HR	280	284	230	234	.474	.474	111°

XTREME MARINE™ Hydraulic Roller Camshafts

1987-98 305-350 Engines With O.E. Hyd. Roller Cams (EXCEPT LT1 & LT4)

HYDRAULIC ROLLER – Good for pleasure use and economy, smooth idle.	Hyd.	Hyd.	1000 to 5000	08-416-8⁴⁶	XM264HR	264	270	212	218	.488	.495	112°
HYDRAULIC ROLLER – Largest for inboard/outboard, very good mid-range.	Hyd.	Hyd.	1200 to 5200	08-417-8⁴⁶	XM270HR	270	276	218	224	.495	.503	112°
HYDRAULIC ROLLER – Good for jet boat w/ A or B impeller, strong mid-range power, needs good exhaust.	Hyd.	Hyd.	1500 to 5500	08-418-8⁴⁶	XM276HR	276	282	224	230	.503	.510	112°

² Requires machining on cylinder heads
⁷ Stock springs cannot be used

¹¹ Lifters only, does not include lifter retainers or guides

¹⁵ 50-State legal on 1993 & earlier SB Chevrolet V8, 262-400c.i. C.A.R.B. E.O. #D-279-4

CHEVROLET 262-400 C.I. 8 CYL. 1958-1998 (CONTINUED)

CAMSHAFTS GENERAL MOTORS

K-KIT	SK-KIT	CL-KIT	LIFTERS	DIST. GEAR	TIMING SET	ROCKER ARMS	PUSHRODS	VALVE SPRINGS	RETAINERS	VALVE LOCKS	VALVE SEALS
XTREME ENERGY™ Hydraulic Roller Camshafts (CARBURETED) (CONTINUED)											
K08-433-8	SK08-433-8 ⁷	CL08-433-8 ⁷	850-16 ¹¹ 875-16 ¹¹	412M	2136 3136	1417-16 ¹⁵ 1617-16 ¹⁵	7808-16 7608-16	986-16 ² 26986-16 ²	740-16 795-16	611-16 614-16	503-16 ²
K08-443-8	SK08-443-8 ⁷	CL08-443-8 ⁷	850-16 ¹¹ 875-16 ¹¹	412M	2136 3136	1417-16 ¹⁵ 1617-16 ¹⁵	7808-16 7608-16	987-16 ² 26986-16 ²	740-16 795-16	611-16 614-16	503-16 ²
K08-444-8	SK08-444-8 ⁷	CL08-444-8 ⁷	850-16 ¹¹ 15850-16 ¹¹	412M	2136 3136	1417-16 ¹⁵ 1617-16 ¹⁵	7808-16 7608-16	987-16 ² 26986-16 ²	740-16 795-16	611-16 614-16	503-16 ²

K-KIT	GK-KIT	CL-KIT	LIFTERS	TIMING SET	GEAR DRIVE	ROCKER ARMS	PUSHRODS	VALVE SPRINGS	RETAINERS	VALVE LOCKS	VALVE SEALS
THUMPR™ Retro-Fit Hydraulic Roller Camshafts (CARBURETED)											
K08-600-8	GK08-600-8 ^{7,93}	CL08-600-8 ⁷	850-16 ¹¹ 875-16 ¹¹	2136 3136	4136	1417-16 ¹⁵ 1617-16 ¹⁵	7608-16 7940-16	26981-16 26918-16	787-16	648-16	501-16
K08-601-8	GK08-601-8 ^{7,93}	CL08-601-8 ⁷	850-16 ¹¹ 875-16 ¹¹	2137 3136	4136	1417-16 ¹⁵ 1617-16 ¹⁵	7608-16 7940-16	26918-16 26986-16 ²	787-16 795-16	648-16 611-16	501-16 503-16 ²
K08-602-8	GK08-602-8 ^{7,93}	CL08-602-8 ⁷	850-16 ¹¹ 875-16 ¹¹	2138 3136	4136	1417-16 ¹⁵ 1617-16 ¹⁵	7608-16 7940-16	26918-16 26986-16 ²	787-16 795-16	648-16 611-16	501-16 503-16 ²

K-KIT	SK-KIT	CL-KIT	LIFTERS	DIST. GEAR	TIMING	ROCKER ARMS	PUSHRODS	VALVE SPRINGS	RETAINERS	VALVE LOCKS	VALVE SEALS
XTREME 4X4™ Hydraulic Roller Camshafts (CARBURETED)											
K08-409-8	SK08-409-8 ⁷	CL08-409-8 ⁷	850-16 ¹¹ 875-16 ¹¹	412M	2136 3136	1417-16 ¹⁵ 1617-16 ¹⁵	7808-16 7608-16	981-16 26981-16	742-16 787-16	601-16 648-16	501-16 503-16 ²
K08-411-8	SK08-411-8 ⁷	CL08-411-8 ⁷	850-16 ¹¹ 875-16 ¹¹	412M	2136 3136	1417-16 ¹⁵ 1617-16 ¹⁵	7808-16 7608-16	981-16 26981-16	742-16 787-16	601-16 648-16	501-16 503-16 ²
K08-413-8	SK08-413-8 ⁷	CL08-413-8 ⁷	850-16 ¹¹ 875-16 ¹¹	412M	2136 3136	1417-16 ¹⁵ 1617-16 ¹⁵	7808-16 7608-16	981-16 26981-16	742-16 787-16	601-16 648-16	501-16 503-16 ²
K08-414-8	SK08-414-8 ⁷	CL08-414-8 ⁷	850-16 ¹¹ 875-16 ¹¹	412M	2136 3136	1417-16 ¹⁵ 1617-16 ¹⁵	7808-16 7608-16	981-16 26981-16	742-16 787-16	601-16 648-16	501-16 503-16 ²

XTREME MARINE™ Hydraulic Roller Camshafts											
K08-416-8	SK08-416-8 ⁷	CL08-416-8 ⁷	850-16 ¹¹ 875-16 ¹¹	412M	2136 3136	1417-16 ¹⁵ 1617-16 ¹⁵	7808-16 7608-16	986-16 ² 26986-16 ²	740-16 795-16	611-16 614-16	503-16 ²
K08-417-8	SK08-417-8 ⁷	CL08-417-8 ⁷	850-16 ¹¹ 875-16 ¹¹	412M	2136 3136	1417-16 ¹⁵ 1617-16 ¹⁵	7808-16 7608-16	986-16 ² 26986-16 ²	740-16 795-16	611-16 614-16	503-16 ²
K08-418-8	SK08-418-8 ⁷	CL08-418-8 ⁷	850-16 ¹¹ 875-16 ¹¹	412M	2136 3136	1417-16 ¹⁵ 1617-16 ¹⁵	7808-16 7608-16	986-16 ² 26986-16 ²	740-16 795-16	611-16 614-16	503-16 ²

⁴⁶ Must use bronze tip fuel pump pushrod when using high pressure or high volume pump

⁹³ GK-Kit contains cam, lifters & gear drive

RED NUMBERS DENOTE PREMIUM OPTION

CHEVROLET 262-400 C.I. 8 CYL. 1958-1998 (CONTINUED)

APPLICATIONS/CAMSHAFTS	VALVE SETTING		RPM OPERATING RANGE	CAM PART #	CAM GRIND #	DURATION				VALVE LIFT		LOBE SEP. ANGLE
	IN.	EX.				ADVERTISED IN.	EX.	@ .050" IN.	EX.	W/ 1.5 ROCKER IN.	EX.	
NITROUS HP™ Hydraulic Roller Camshafts (CARBURETED)												
1987-98 305-350 Engines With O.E. Hyd. Roller Cams (EXCEPT LT1 & LT4)												
HYDRAULIC ROLLER – 125+ HP nitrous or small supercharger, low gears, headers, 2200+ stall.	Hyd.	Hyd.	2000 to 6000	08-301-8⁴⁶	NX276HR	276	288	224	236	.502	.520	113°
HYDRAULIC ROLLER – 175+ HP nitrous system. 2500+ stall with lower gears and headers.	Hyd.	Hyd.	2400 to 6500	08-303-8⁴⁶	NX288HR	288	315	236	248	.520	.540	113°
XTREME ENERGY™ Computer Controlled Hydraulic Roller Camshafts												
1987-98 305-350 Engines With O.E. Hyd. Roller Cams (EXCEPT LT1 & LT4)												
HYDRAULIC ROLLER – For throttle body 305 or 350, very good economy and power.	Hyd.	Hyd.	1000 to 5000	08-500-8⁴⁶	XR258HR	258	264	206	212	.480	.488	112°
HYDRAULIC ROLLER – Best in 305 or 350 tuned port injected engines.	Hyd.	Hyd.	1200 to 5200	08-501-8⁴⁶	XR264HR	264	269	212	218	.488	.495	112°
HYDRAULIC ROLLER – Good for TPI 305 or 350 with upgraded exhaust. Requires custom tuning.	Hyd.	Hyd.	1500 to 5500	08-502-8⁴⁶	XR269HR	269	276	218	224	.495	.503	112°
HYDRAULIC ROLLER – Needs modified TPI w/injectors, plenum, runners, exhaust, 2000+ stall. Requires custom tuning.	Hyd.	Hyd.	1800 to 5800	08-503-8⁴⁶	XR276HR	276	281	224	230	.503	.510	112°
COMPUTER CONTROLLED Hydraulic Roller Camshafts												
1987-98 305-350 Engines With O.E. Hyd. Roller Cams (EXCEPT LT1 & LT4)												
HYDRAULIC ROLLER – Good torque & mileage with tuned port injection.	Hyd.	Hyd.	1000 to 5000	08-300-8⁴⁶	262HR-12	262	264	206	210	.450	.480	112°
HYDRAULIC ROLLER – Mild performance for TPI. Strong low to mid-range power. Requires custom tuning.	Hyd.	Hyd.	1200 to 5200	08-302-8⁴⁶	264HR-12	264	274	210	220	.480	.480	112°
HYDRAULIC ROLLER – Great mid-range power with modified TPI application. Requires custom tuning.	Hyd.	Hyd.	1400 to 5400	08-304-8⁴⁶	266HR-14	266	276	210	220	.500	.510	114°
HYDRAULIC ROLLER – High performance street for modified TPI, 2000+ stall. Requires custom tuning.	Hyd.	Hyd.	1800 to 5800	08-305-8⁴⁶	276HR-14	276	290	220	230	.510	.510	114°
HYDRAULIC ROLLER – Street/strip applications. Needs 2500+ stall, lower gears. Requires custom tuning.	Hyd.	Hyd.	2000 to 6000	08-306-8⁴⁶	290HR-12	290	307	230	244	.510	.540	112°
XTREME FUEL INJECTION (XFI™) Hydraulic Roller Camshafts												
1987-98 305-350 Engines With O.E. Hyd. Roller Cams (w/1.6 Rockers) (EXCEPT LT1 & LT4)												
HYDRAULIC ROLLER – Excellent torque for throttle body 305 or 350. Good economy with added power.	Hyd.	Hyd.	1000 to 5000	08-464-8⁴⁶	252XFI HR13	252	264	202	212	.550	.546	113°
HYDRAULIC ROLLER – Superb low end & mid-range for 350 tuned port injections. Requires custom tuning.	Hyd.	Hyd.	1200 to 5200	08-465-8⁴⁶	260XFI HR13	260	270	210	218	.560	.555	113°
HYDRAULIC ROLLER – Good torque with exceptional mid-range power for 305 and 350 TPI applications. Needs upgraded exhaust and custom tuning.	Hyd.	Hyd.	1800 to 5800	08-466-8⁴⁶	268XFI HR13	268	276	218	224	.570	.565	113°
HYDRAULIC ROLLER – Strong mid-range and top end. Will require headers, gears and stall. Strong Idle. Requires custom tuning.	Hyd.	Hyd.	2000 to 6000	08-467-8⁴⁶	280XFI HR13	280	288	230	236	.576	.570	113°
HYDRAULIC ROLLER – Excellent top end power. Needs headers, gears & 2500+ stall. Requires custom tuning.	Hyd.	Hyd.	2200 to 6200	08-468-8⁴⁶	292XFI HR13	292	300	242	248	.584	.579	113°

² Requires machining on cylinder heads⁷ Stock springs cannot be used¹¹ Lifters only, does not include lifter retainers or guides¹⁵ 50-State legal on 1993 & earlier SB Chevrolet V8, 262-400c.i. C.A.R.B. E.O. #D-279-4

CHEVROLET 262-400 C.I. 8 CYL. 1958-1998 (CONTINUED)

CAMSHAFTS GENERAL MOTORS

K-KIT	SK-KIT	CL-KIT	LIFTERS	DIST. GEAR	TIMING SET	ROCKER ARMS	PUSHRODS	VALVE SPRINGS	RETAINERS	VALVE LOCKS	VALVE SEALS
NITROUS HP™ Hydraulic Roller Camshafts (CARBURETED)											
K08-301-8	SK08-301-8 ⁷	CL08-301-8 ⁷	850-16 ¹¹ 875-16 ¹¹	412M	2136 3136	1417-16 ¹⁵ 1617-16 ¹⁵	7808-16 7940-16	986-16 ² 26986-16 ²	740-16 795-16	611-16 614-16	503-16 ²
K08-303-8	SK08-303-8 ⁷	CL08-303-8 ⁷	850-16 ¹¹ 875-16 ¹¹	412M	2136 3136	1417-16 ¹⁵ 1617-16 ¹⁵	7808-16 7940-16	986-16 ² 26986-16 ²	740-16 795-16	611-16 614-16	503-16 ²
XTREME ENERGY™ Computer Controlled Hydraulic Roller Camshafts											
K08-500-8	SK08-500-8 ⁷	CL08-500-8 ⁷	850-16 ¹¹ 875-16 ¹¹	412M	2136 3136	1417-16 ¹⁵ 1617-16 ¹⁵	7808-16 7608-16	981-16 26981-16	742-16 787-16	601-16 648-16	501-16 503-16 ²
K08-501-8	SK08-501-8 ⁷	CL08-501-8 ⁷	850-16 ¹¹ 875-16 ¹¹	412M	2136 3136	1417-16 ¹⁵ 1617-16 ¹⁵	7808-16 7608-16	986-16 ² 26986-16 ²	740-16 795-16	611-16 614-16	503-16 ²
K08-502-8	SK08-502-8 ⁷	CL08-502-8 ⁷	850-16 ¹¹ 875-16 ¹¹	412M	2136 3136	1417-16 ¹⁵ 1617-16 ¹⁵	7808-16 7608-16	986-16 ² 26986-16 ²	740-16 795-16	611-16 614-16	503-16 ²
K08-503-8	SK08-503-8 ⁷	CL08-503-8 ⁷	850-16 ¹¹ 875-16 ¹¹	412M	2136 3136	1417-16 ¹⁵ 1617-16 ¹⁵	7808-16 7608-16	986-16 ² 26986-16 ²	740-16 795-16	611-16 614-16	503-16 ²
COMPUTER CONTROLLED Hydraulic Roller Camshafts											
K08-300-8	SK08-300-8 ⁷	CL08-300-8 ⁷	850-16 ¹¹ 875-16 ¹¹	412M	2136 3136	1417-16 ¹⁵ 1617-16 ¹⁵	7808-16 7608-16	983-16 26981-16	751-16 795-16	611-16 613-16	501-16 503-16 ²
K08-302-8	SK08-302-8 ⁷	CL08-302-8 ⁷	850-16 ¹¹ 875-16 ¹¹	412M	2136 3136	1417-16 ¹⁵ 1617-16 ¹⁵	7808-16 7608-16	983-16 26981-16	751-16 795-16	611-16 613-16	501-16 503-16 ²
K08-304-8	SK08-304-8 ⁷	CL08-304-8 ⁷	850-16 ¹¹ 875-16 ¹¹	412M	2136 3136	1417-16 ¹⁵ 1617-16 ¹⁵	7808-16 7608-16	986-16 ² 26986-16 ²	740-16 795-16	611-16 614-16	503-16 ²
K08-305-8	SK08-305-8 ⁷	CL08-305-8 ⁷	850-16 ¹¹ 875-16 ¹¹	412M	2136 3136	1417-16 ¹⁵ 1617-16 ¹⁵	7808-16 7608-16	986-16 ² 26986-16 ²	740-16 795-16	611-16 614-16	503-16 ²
K08-306-8	SK08-306-8 ⁷	CL08-306-8 ⁷	850-16 ¹¹ 875-16 ¹¹	412M	2136 3136	1417-16 ¹⁵ 1617-16 ¹⁵	7808-16 7608-16	986-16 ² 26986-16 ²	740-16 795-16	611-16 614-16	503-16 ²
XTREME FUEL INJECTION (XFI™) Hydraulic Roller Camshafts											
K08-464-8	SK08-464-8 ⁷	CL08-464-8 ⁷	850-16 ¹¹ 875-16 ¹¹	412M	2136 3136	1418-16 1618-16	7808-16 7608-16	26986-16	787-16 1787-16	601-16 648-16	501-16 503-16 ²
K08-465-8	SK08-465-8 ⁷	CL08-465-8 ⁷	850-16 ¹¹ 875-16 ¹¹	412M	2136 3136	1418-16 1618-16	7808-16 7608-16	26986-16	787-16 1787-16	601-16 648-16	501-16 503-16 ²
K08-466-8	SK08-466-8 ⁷	CL08-466-8 ⁷	850-16 ¹¹ 875-16 ¹¹	412M	2136 3136	1418-16 1618-16	7808-16 7608-16	26986-16	787-16 1787-16	601-16 648-16	501-16 503-16 ²
K08-467-8	SK08-467-8 ⁷	CL08-467-8 ⁷	850-16 ¹¹ 875-16 ¹¹	412M	2136 3136	1418-16 1618-16	7808-16 7608-16	26986-16	787-16 1787-16	601-16 648-16	501-16 503-16 ²
K08-468-8	SK08-468-8 ⁷	CL08-468-8 ⁷	850-16 ¹¹ 15850-16 ¹¹	412M	2136 3136	1418-16 1618-16	7808-16 7608-16	26986-16	787-16 1787-16	601-16 648-16	501-16 503-16 ²

⁴⁶ Must use bronze tip fuel pump pushrod when using high pressure or high volume pump



CHEVROLET 262-400 C.I. 8 CYL. 1958-1998 (CONTINUED)

APPLICATIONS/CAMSHAFTS	VALVE SETTING		RPM OPERATING RANGE	CAM PART #	CAM GRIND #	DURATION				VALVE LIFT		LOBE SEP. ANGLE
	IN.	EX.				IN.	EX.	IN.	EX.	IN.	EX.	

TRI-POWER XTREME™ Hydraulic Roller Camshafts

1987-98 305-350 Engines With O.E. Hyd. Roller Cams (EXCEPT LT1 & LT4)

HYDRAULIC ROLLER – Optimized fuel mileage with good torque and horsepower.	Hyd.	Hyd.	800 to 5000	08-525-8⁴⁶	TPX246HR-16	246	258	194	206	.470	.464	116°
HYDRAULIC ROLLER – Exceptional torque with good horsepower and moderate fuel economy.	Hyd.	Hyd.	1200 to 5200	08-530-8⁴⁶	TPX254HR-15	254	264	202	212	.477	.471	115°
HYDRAULIC ROLLER – Optimized horsepower with good torque and average fuel economy.	Hyd.	Hyd.	1400 to 5400	08-535-8⁴⁶	TPX262HR-14	262	270	210	218	.486	.480	114°

APPLICATIONS/CAMSHAFTS	VALVE SETTING		RPM OPERATING RANGE	CAM PART #	CAM GRIND #	DURATION				VALVE LIFT		LOBE SEP. ANGLE
	IN.	EX.				IN.	EX.	IN.	EX.	IN.	EX.	

4-PATTERN O.E Hydraulic Roller Camshafts (W/ 1.6 ROCKERS)

1987-98, 305-350 Engines With O.E. Hyd. Roller (EXCEPT LT1 & LT4) (Larger Cam Lobes For Outboard Cylinders)

HYDRAULIC ROLLER – Best choice for smaller c.i. applications with very good heads. Extremely wide power range. 1800+ Stall.	Hyd.	Hyd.	1700-6300	08-604-44	269QI08	271 OB	283 OB	219 OB	229 OB	.603 OB	.590 OB	108.5 OB
						269 IB	281 IB	217 IB	227 IB	.600 IB	.587 IB	107.5 IB
HYDRAULIC ROLLER – Great all around choice for street applications in modified engines and 2500+ stall or manual transmissions	Hyd.	Hyd.	2300-6600	08-605-44	281QI08	283 OB	295 OB	231 OB	241 OB	.622 OB	.610 OB	108.5 OB
						281 IB	293 IB	229 IB	239 IB	.619 IB	.606 IB	107.5 IB
HYDRAULIC ROLLER – Excellent for street/strip applications with good heads and raised compression in high RPM engines. 3200+ Stall.	Hyd.	Hyd.	2900-7200	08-607-44	293QI08	295 OB	307 OB	243 OB	253 OB	.638 OB	.622 OB	108.5 OB
						293 IB	305 IB	241 IB	251 IB	.637 IB	.622 IB	107.5 IB
HYDRAULIC ROLLER – Recommended in larger c.i. and high compression applications. 3500+ Stall.	Hyd.	Hyd.	3300-7500	08-609-44	305QI08	307 OB	319 OB	255 OB	265 OB	.638 OB	.622 OB	108.5 OB
						305 IB	317 IB	253 IB	263 IB	.638 IB	.622 IB	107.5 IB

4-PATTERN Small Base Circle (.900") O.E Hydraulic Roller Camshafts (W/ 1.6 ROCKERS)

1987-98, 305-350 Engines With O.E. Hyd. Roller (EXCEPT LT1 & LT4) (Larger Cam Lobes For Outboard Cylinders)

HYDRAULIC ROLLER – Best choice for street 383 stroker engines with good cylinder heads. Very wide power range. 2600+ Stall.	Hyd.	Hyd.	2400-6700	08-606-44	287QS9	289 OB	301 OB	236 OB	246 OB	.630 OB	.618 OB	109.5 OB
						287 IB	299 IB	234 IB	244 IB	.627 IB	.614 IB	108.5 IB
HYDRAULIC ROLLER – Great in larger c.i. street to street/strip stroker small blocks w/ good heads.	Hyd.	Hyd.	2900-7200	08-608-44	299QS10	301 OB	313 OB	248 OB	258 OB	.637 OB	.621 OB	110.5 OB
						299 IB	311 IB	246 IB	256 IB	.637 IB	.621 IB	109.5 IB
HYDRAULIC ROLLER – Recommended in highly modified 420+ c.i. stroker applications with higher compression. 3500+ Stall.	Hyd.	Hyd.	3200-7500	08-610-44	311QS10	313 OB	325 OB	260 OB	270 OB	.637 OB	.621 OB	110.5 OB
						311 IB	323 IB	258 IB	268 IB	.637 IB	.621 IB	109.5 IB

TECH TIP If you have a 1955-1957 Small Block Chevy engine, please notify your sales person before ordering.

² Requires machining on cylinder heads

¹¹ Lifters only, does not include lifter retainers or guides

¹⁵ 50-State legal on 1993 & earlier SB Chevrolet V8, 262-400c.i. C.A.R.B. E.O. #D-279-4

CHEVROLET 262-400 C.I. 8 CYL. 1958-1998 (CONTINUED)

CAMSHAFTS GENERAL MOTORS

LIFTERS	TIMING SET	ROCKER ARMS	PUSHRODS	VALVE SPRINGS	RETAINERS	VALVE LOCKS	VALVE SEALS	LASH CAPS	REV KIT	DIST. GEAR	STUD GIRDLES
TRI-POWER XTREME™ Hydraulic Roller Camshafts											
850-16 ¹¹ 875-16 ¹¹	2136 3136	1417-16 ¹⁵ 1617-16 ¹⁵	7808-16 7608-16	26981-16 26986-16 ²	787-16 1787-16	601-16 648-16	501-16 503-16 ²	N/A	N/A	412M	N/A
850-16 ¹¹ 875-16 ¹¹	2136 3136	1417-16 ¹⁵ 1617-16 ¹⁵	7808-16 7608-16	26981-16 26986-16 ²	787-16 1787-16	601-16 648-16	501-16 503-16 ²	N/A	N/A	412M	N/A
850-16 ¹¹ 875-16 ¹¹	2136 3136	1417-16 ¹⁵ 1617-16 ¹⁵	7808-16 7608-16	26981-16 26986-16 ²	787-16 1787-16	601-16 648-16	501-16 503-16 ²	N/A	N/A	412M	N/A

LIFTERS	TIMING SET	ROCKER ARMS	PUSHRODS	VALVE SPRINGS	RETAINERS	VALVE LOCKS	VALVE SEALS	LASH CAPS	REV KIT	DIST. GEAR	STUD GIRDLES
4-PATTERN O.E Hydraulic Roller Camshafts (W/ 1.6 ROCKERS)											
15850-16	7136	1618-16	7608-16 7940-16	26926-16	1777-16	648-16	518-16	N/A	N/A	412M	N/A
15850-16	7136	1618-16	7608-16 7940-16	26926-16	1777-16	648-16	518-16	N/A	N/A	412M	N/A
15850-16	7136	1618-16	7608-16 7940-16	26926-16	1777-16	648-16	518-16	N/A	N/A	412M	N/A
15850-16	7136	1618-16	7608-16 7940-16	26926-16	1777-16	648-16	518-16	N/A	N/A	412M	N/A

4-PATTERN Small Base Circle (.900") O.E Hydraulic Roller Camshafts (W/ 1.6 ROCKERS)											
15850-16	7136	1618-16	7608-16 7940-16	26926-16	1777-16	648-16	518-16	N/A	N/A	412M	N/A
15850-16	7136	1618-16	7608-16 7940-16	26926-16	1777-16	648-16	518-16	N/A	N/A	412M	N/A
15850-16	7136	1618-16	7608-16 7940-16	26926-16	1777-16	648-16	518-16	N/A	N/A	412M	N/A

⁴⁶ Must use bronze tip fuel pump pushrod when using high pressure or high volume pump

CHEVROLET 262-400 C.I. 8 CYL. 1958-1998 (CONTINUED)

APPLICATIONS/CAMSHAFTS	VALVE SETTING		RPM OPERATING RANGE	CAM PART #	CAM GRIND #	DURATION				VALVE LIFT		LOBE SEP. ANGLE
	IN.	EX.				ADVERTISED IN.	EX.	@ .050" IN.	EX.	W/ 1.5 ROCKER IN.	EX.	
MAGNUM Mechanical Flat Tappet Camshafts												
SOLID – Streetable. Works with stock converter, best with 2000+. Lower gears. Noticeable idle.	.022	.022	1500 to 5500	12-222-4	270S	270	270	224	224	.468	.468	110°
SOLID – Good power for street, choppy idle. Needs 2500+ stall, likes headers and low gears.	.022	.022	2000 to 6000	12-223-4	282S	282	282	236	236	.495	.495	110°
SOLID – Maximum street performance, very rough idle, needs headers, 3000+ stall & 9.5:1+ compression.	.022	.022	2500 to 6500	12-224-4	294S	294	294	248	248	.525	.525	110°
SOLID – Street/strip. 3500+ stall, 10.5:1 compression. Low gears, headers and intake. Racy idle.	.022	.022	3000 to 7000	12-225-4	306S	306	306	260	260	.555	.555	110°
XTREME ENERGY™ Mechanical Flat Tappet Camshafts												
SOLID – Strong torque thru low end and mid-range, good idle.	.016	.016	1000 to 5600	12-674-4	XS256S	256	262	218	224	.465	.477	110°
SOLID – Excellent response, good mid-range, noticeable idle.	.016	.016	1300 to 5800	12-675-4	XS262S	262	268	224	230	.477	.488	110°
SOLID – Great for street machines. Will work with stock converter, best with 2000 stall.	.016	.016	1600 to 6000	12-676-4	XS268S	268	274	230	236	.488	.501	110°
SOLID – Very strong mid-range torque and throttle response, 2200+ stall.	.016	.016	2000 to 6400	12-677-4	XS274S	274	280	236	242	.501	.510	110°
SOLID – Street/strip, 2800+ stall, likes headers and gears, rough idle.	.016	.016	2400 to 6800	12-678-4	XS282S	282	290	244	252	.520	.540	110°
SOLID – Pro street/bracket, needs good intake, headers, gear and 3300+ stall.	.016	.016	2800 to 7200	12-679-5	XS290S	290	298	252	260	.540	.558	110°
XTREME ENERGY™ 4 & 7 SWAP FIRING ORDER Mechanical Flat Tappet Camshafts												
(18736542 Firing Order)												
SOLID – Very strong mid-range, torque and throttle response. 2200+stall.	.016	.016	2000 to 6400	12-663-47	XE274S	274	280	236	242	.501	.510	110°
SOLID – Street/Strip, 2800+ stall, likes headers and gears, rough idle. Good for oval track vacuum rule applications.	.016	.016	2400 to 6800	12-664-47	XE282S	282	290	244	252	.520	.540	110°
SOLID – Pro Street/bracket, needs good intake, headers, gear and 3300+stall.	.016	.016	2800 to 7200	12-665-47	XE290S	290	298	252	260	.540	.558	110°
NOSTALGIA PLUS™ Mechanical Flat Tappet Camshaft												
SOLID – Outstanding power and modern tight lash with the exhaust note of the GM 30-30 cam.	.012	.012	2300 to 6900	12-673-4	N+30-30S	284	291	247	254	.504	.498	112°

² Requires machining on cylinder heads
⁷ Stock springs cannot be used

¹⁵ 50-State legal on 1993 & earlier SB Chevrolet V8, 262-400c.i. C.A.R.B. E.O. #D-279-4

⁵² Engines with self-aligning rocker arms must use Part #1417-16 or #1617-16

CHEVROLET 262-400 C.I. 8 CYL. 1958-1998 (CONTINUED)

CAMSHAFTS
GENERAL MOTORS

K-KIT	SK-KIT	CL-KIT	RP-KIT	LIFTERS	TIMING SET	ROCKER ARMS	PUSHRODS	VALVE SPRINGS	RETAINERS	VALVE LOCKS	VALVE SEALS	
MAGNUM Mechanical Flat Tappet Camshafts												
K12-222-4	SK12-222-4 ⁷	CL12-222-4 ⁷	RP1412-16 RPM1601-16	813-16 800-16	2100 3100	1412-16 ^{15,52} 1601-16 ^{15,52}	7372-16 7972-16	981-16 26981-16	742-16 787-16	601-16 648-16	501-16	
K12-223-4	SK12-223-4 ⁷	CL12-223-4 ⁷	RP1412-16 RPM1601-16	813-16 800-16	2100 3100	1412-16 ^{15,52} 1601-16 ^{15,52}	7372-16 7972-16	981-16 26981-16	742-16 787-16	601-16 648-16	501-16	
K12-224-4	SK12-224-4 ⁷	CL12-224-4 ⁷	RP1412-16 RPM1601-16	813-16 800-16	2100 3100	1412-16 ^{15,52} 1601-16 ^{15,52}	7372-16 7972-16	986-16 ² 26986-16 ²	740-16 795-16	611-16 614-16	503-16 ²	
K12-225-4	SK12-225-4 ⁷	CL12-225-4 ⁷	RP1412-16 RPM1601-16	813-16 800-16	2100 3100	1412-16 ^{15,52} 1601-16 ^{15,52}	7372-16 7972-16	986-16 ² 26986-16 ²	740-16 795-16	611-16 614-16	503-16 ²	
XTREME ENERGY™ Mechanical Flat Tappet Camshafts												
K12-674-4	SK12-674-4 ⁷	CL12-674-4 ⁷	RP1412-16 RPM1601-16	813-16 800-16	2100 3100	1412-16 ^{15,52} 1601-16 ^{15,52}	7372-16 7972-16	981-16 26981-16	742-16 787-16	601-16 648-16	501-16	
K12-675-4	SK12-675-4 ⁷	CL12-675-4 ⁷	RP1412-16 RPM1601-16	813-16 800-16	2100 3100	1412-16 ^{15,52} 1601-16 ^{15,52}	7372-16 7972-16	981-16 26981-16	742-16 787-16	601-16 648-16	501-16	
K12-676-4	SK12-676-4 ⁷	CL12-676-4 ⁷	RP1412-16 RPM1601-16	813-16 800-16	2100 3100	1412-16 ^{15,52} 1601-16 ^{15,52}	7372-16 7972-16	986-16 ² 26986-16 ²	740-16 795-16	611-16 614-16	503-16 ²	
K12-677-4	SK12-677-4 ⁷	CL12-677-4 ⁷	RP1412-16 RPM1601-16	813-16 800-16	2100 3100	1412-16 ^{15,52} 1601-16 ^{15,52}	7372-16 7972-16	986-16 ² 26986-16 ²	740-16 795-16	611-16 614-16	503-16 ²	
K12-678-4	SK12-678-4 ⁷	CL12-678-4 ⁷	RP1412-16 RPM1601-16	813-16 800-16	2100 3100	1412-16 ^{15,52} 1601-16 ^{15,52}	7372-16 7972-16	986-16 ² 26986-16 ²	740-16 795-16	611-16 614-16	503-16 ²	
K12-679-5	SK12-679-5 ⁷	CL12-679-5 ⁷	RP1412-16 RPM1601-16	813-16 800-16	2100 3100	1412-16 ^{15,52} 1601-16 ^{15,52}	7372-16 7972-16	986-16 ² 26986-16 ²	740-16 795-16	611-16 614-16	503-16 ²	
LIFTERS	TIMING SET	ROCKER ARMS	PUSHRODS	VALVE SPRINGS	RETAINERS	VALVE LOCKS	VALVE SEALS	LASH CAPS	REV KIT	DIST. GEAR	STUD GIRDLES	
XTREME ENERGY™ 4 & 7 SWAP FIRING ORDER Mechanical Flat Tappet Camshafts												
813-16 800-16	2100 3100	1601-16 ^{15,52} 1801-16 ^{15,52}	7372-16 7972-16	986-162 26986-16 ²	740-16 795-16	611-16 614-16	503-16 ²	621-16	N/A	12200 12140	4001	
813-16 800-16	2100 3100	1601-16 ^{15,52} 1801-16 ^{15,52}	7372-16 7972-16	986-162 26986-16 ²	740-16 795-16	611-16 614-16	503-16 ²	621-16	N/A	12200 12140	4001	
813-16 800-16	2100 3100	1601-16 ^{15,52} 1801-16 ^{15,52}	7372-16 7972-16	986-16 ² 26986-16 ²	740-16 795-16	611-16 614-16	503-16 ²	621-16	N/A	12200 12140	4001	
K-KIT	SK-KIT	CL-KIT	RP-KIT	LIFTERS	TIMING SET	ROCKER ARMS	PUSHRODS	VALVE SPRINGS	RETAINERS	VALVE LOCKS	VALVE SEALS	
NOSTALGIA PLUS™ Mechanical Flat Tappet Camshaft												
K12-673-4	SK12-673-4 ⁷	CL12-673-4 ⁷	RP1412-16 RPM1601-16	813-16 800-16	2100 3100	1412-16 ^{15,52} 1601-16 ^{15,52}	7372-16 7972-16	986-16 ² 26986-16 ²	740-16 795-16	611-16 614-16	503-16 ²	

RED NUMBERS DENOTE PREMIUM OPTION



CHEVROLET 262-400 C.I. 8 CYL. 1958-1998 (CONTINUED)

APPLICATIONS/CAMSHAFTS	VALVE SETTING		RPM OPERATING RANGE	CAM PART #	CAM GRIND #	DURATION				VALVE LIFT		LOBE SEP. ANGLE
	IN.	EX.				IN.	EX.	@ .050"	W/ 1.5 ROCKER	IN.	EX.	
FACTORY MUSCLE™ Mechanical Flat Tappet Camshaft (Today's Versions Of Yesterday's Muscle Car Cams)												
SOLID – Factory I.D. #3736097 for: 327c.i. Corvette, 340 HP	.010	.012	1500 to 5500	12-108-5	287S	287	291	228	232	.394	.400	110°
SOLID – Factory I.D. #3849346 for: 302c.i., 1967-69 Z28, factory 290 HP 327c.i., 1964-65, factory 365/275 HP 350c.i., 1970-71 LT1, factory 370 HP	.024	.024	2800 to 6800	12-107-3	346S	346	346	254	254	.485	.485	114°
BLOWER & TURBO Mechanical Flat Tappet Camshafts												
SOLID – Mild bracket and hot street with small blower or 471 blower.	.026	.028	3000 to 6500	12-405-5	290AS-14	290	300	255	265	.540	.563	114°
SOLID – Serious bracket race and very hot street with 471 or larger blower.	.026	.028	3500 to 7000	12-406-5	310BS-14	310	320	270	280	.563	.563	114°
PULLER & MUD RACE Mechanical Flat Tappet Camshafts												
SOLID – Excellent torque and good idle for 327-350. Needs 10:1 compression and low gears.	.026	.028	3000 to 6500	12-609-5	285B-6	285	295	250	260	.532	.555	106°
SOLID – Good for 377-406 engine to run high RPM. Requires upgraded cylinder heads and manifold.	.026	.028	3500 to 7200	12-612-5	300B-6	300	314	265	276	.562	.557	106°
DRAG RACE Mechanical Flat Tappet Camshafts												
SOLID – Good torque for heavy car, 10:1 compression. 3000+ stall.	.026	.028	3000 to 6000	12-221-5	280B-8	280	285	242	250	.507	.532	108°
SOLID – 350-400, 12:1 compression, 4000+ stall.	.018	.020	3500 to 6500	12-512-5	280TLS-6	280	288	250	259	.530	.550	106°
SOLID – Great torque, 3800+ stall or 4 speed, 10.5:1 compression.	.026	.028	3500 to 6500	12-609-5 12-609-20⁹⁴	285B-6	285	295	250	260	.532	.555	106°
SOLID – 4000+ stall, 10.5:1 compression and up.	.026	.028	4000 to 7000	12-611-5 12-611-20⁹⁴	290B-6	290	304	255	266	.540	.534	106°
SOLID – 350-400 11:1 compression, 4800+ stall.	.018	.020	4200 to 7200	12-515-5 12-515-20⁹⁴	288TLS-6	288	296	259	266	.550	.570	106°
SOLID – 327-350, 4500+ stall, good power. 11:1 compression.	.026	.028	4200 to 7200	12-612-5 12-612-20⁹⁴	300B-6	300	314	265	276	.562	.557	106°
SOLID – 350-400, 12:1 compression, 4800+ stall.	.018	.020	4500 to 7500	12-517-5 12-517-20⁹⁴	296TLS-6	296	304	266	274	.570	.590	106°
SOLID – 350-400, 11.5:1 minimum compression, ported heads, 5000+ stall.	.026	.028	4700 to 7500	12-518-5	300F-6	300	316	270	278	.580	.577	106°
SOLID – 350-400, 12:1 compression, 5000+ stall.	.018	.020	5000 to 7700	12-519-5	304TLS-6	304	312	274	282	.590	.610	106°
SOLID – 350c.i. and up, 12:1+ compression, 5000+ stall, light car.	.026	.028	5000 to 7700	12-614-5	310B-4	310	320	275	283	.585	.588	104°
DRAG RACE 4 & 7 SWAP FIRING ORDER Mechanical Flat Tappet Camshafts												
18736542 Firing Order												
SOLID – 4000+ stall, 10.5:1 compression and up.	.026	.028	4000 to 7000	12-686-47	47S 290B-6	290	304	255	266	.540	.534	106°
SOLID – 350-400, 12:1 compression, 4800+ stall.	.018	.020	4500 to 7500	12-687-47	47S 296TLS-6	296	304	266	274	.570	.590	106°

² Requires machining on cylinder heads
¹⁵ 50-State legal on 1993 & earlier SB Chevrolet V8, 262-400c.i. C.A.R.B. E.O. #D-279-4

⁴⁸ Includes 3 cam bolts, thrust bearing, adjustable cam timing system, 2 machined steel gears & true roller chain

⁵² Engines with self-aligning rocker arms must use Part #1417-16 or #1617-16

CHEVROLET 262-400 C.I. 8 CYL. 1958-1998 (CONTINUED)

CAMSHAFTS GENERAL MOTORS

LIFTERS	TIMING SET	ROCKER ARMS	PUSHRODS	VALVE SPRINGS	RETAINERS	VALVE LOCKS	VALVE SEALS	LASH CAPS	REV KIT	DIST. GEAR	STUD GIRDLES
FACTORY MUSCLE™ Mechanical Flat Tappet Camshaft (Today's OEM Versions Of Yesterday's Muscle Car Cams)											
813-16 800-16	3100 3100KT ⁴⁸	19001-16 1601-16 ^{15,52}	7372-16 7972-16	981-16 26981-16	750-16 795-16	613-16 614-16	501-16 503-16 ²	621-16	N/A	12200 12140	4001
813-16 800-16	3100 3100KT ⁴⁸	19001-16 1601-16 ^{15,52}	7372-16 7972-16	981-16 26981-16	750-16 795-16	613-16 614-16	501-16 503-16 ²	621-16	N/A	12200 12140	4001
BLOWER & TURBO Mechanical Flat Tappet Camshafts											
813-16 800-16	3100 3100KT ⁴⁸	1601-16 ^{15,52} 1801-16 ^{15,52}	7372-16 7972-16	987-16 ² 978-16 ²	740-16 730-16	611-16	503-16 ²	621-16	N/A	12200 12140	4001
813-16 800-16	3100 3100KT ⁴⁸	1601-16 ^{15,52} 1801-16 ^{15,52}	7372-16 7972-16	987-16 ² 978-16 ²	740-16 730-16	611-16	503-16 ²	621-16	N/A	12200 12140	4001
PULLER & MUD RACE Mechanical Flat Tappet Camshafts											
813-16 800-16	3100 3100KT ⁴⁸	19001-16 1801-16 ^{15,52}	7372-16 7972-16	987-16 ² 978-16 ²	740-16 730-16	611-16	503-16 ²	621-16	N/A	12200 12140	4001
813-16 800-16	3100 3100KT ⁴⁸	1601-16 ^{15,52} 1801-16 ^{15,52}	7372-16 7972-16	987-16 ² 978-16 ²	740-16 730-16	611-16	503-16 ²	621-16	N/A	12200 12140	4001
DRAG RACE Mechanical Flat Tappet Camshafts											
813-16 800-16	3100 3100KT ⁴⁸	19001-16 1601-16 ^{15,52}	7972-16	987-16 ² 978-16 ²	740-16 1730-16	611-16	503-16 ²	621-16	N/A	12200 12140	4001
813-16 800-16	3100 3100KT ⁴⁸	1601-16 ¹⁵ 1801-16 ¹⁵	7972-16	987-16 ² 978-16 ²	740-16 730-16	611-16	503-16 ²	621-16	N/A	12200 12140	4001
813-16 800-16	3100 3100KT ⁴⁸	1601-16 ¹⁵ 1801-16 ¹⁵	7972-16	987-16 ² 978-16 ²	740-16 730-16	611-16	503-16 ²	621-16	N/A	12200 12140	4001
813-16 800-16	3100 3100KT ⁴⁸	1601-16 ¹⁵ 1801-16 ¹⁵	7972-16	987-16 ² 978-16 ²	740-16 730-16	611-16	503-16 ²	621-16	N/A	12200 12140	4001
813-16 800-16	3100 3100KT ⁴⁸	1601-16 ¹⁵ 1801-16 ¹⁵	7972-16	987-16 ² 978-16 ²	740-16 730-16	611-16	503-16 ²	621-16	N/A	12200 12140	4001
813-16 800-16	3100 3100KT ⁴⁸	1601-16 ¹⁵ 1801-16 ¹⁵	7972-16	987-16 ² 978-16 ²	740-16 730-16	611-16	503-16 ²	621-16	N/A	12200 12140	4001
813-16 800-16	3100 3100KT ⁴⁸	1601-16 ¹⁵ 1801-16 ¹⁵	7972-16	987-16 ² 978-16 ²	740-16 730-16	611-16	503-16 ²	621-16	N/A	12200 12140	4001
813-16 800-16	3100 3100KT ⁴⁸	1601-16 ¹⁵ 1801-16 ¹⁵	7972-16	987-16 ² 978-16 ²	740-16 730-16	611-16	503-16 ²	621-16	N/A	12200 12140	4001
813-16 800-16	3100 3100KT ⁴⁸	1601-16 ¹⁵ 1801-16 ¹⁵	7972-16	987-16 ² 978-16 ²	740-16 730-16	611-16	503-16 ²	621-16	N/A	12200 12140	4001
DRAG RACE 4 & 7 SWAP FIRING ORDER Mechanical Flat Tappet Camshafts											
813-16 800-16	3100 3100KT ⁴⁸	1601-16 ¹⁵ 1801-16 ¹⁵	7972-16	987-16 ² 978-16 ²	740-16 730-16	611-16	503-16 ²	621-16	N/A	12200 12140	4001
813-16 800-16	3100 3100KT ⁴⁸	1601-16 ¹⁵ 1801-16 ¹⁵	7972-16	987-16 ² 978-16 ²	740-16 730-16	611-16	503-16 ²	621-16	N/A	12200 12140	4001

⁹⁴ Nitrided version

RED NUMBERS DENOTE PREMIUM OPTION

CHEVROLET 262-400 C.I. 8 CYL. 1958-1998 (CONTINUED)

APPLICATIONS/CAMSHAFTS	VALVE SETTING		RPM OPERATING RANGE	CAM PART #	CAM GRIND #	DURATION				VALVE LIFT		LOBE SEP. ANGLE
	IN.	EX.				ADVERTISED IN.	EX.	@ .050" IN.	EX.	W/ 1.5 ROCKER IN.	EX.	
OVAL TRACK Mechanical Flat Tappet Camshafts												
SOLID – Short tracks with 2 BBL carburetor and stock exhaust manifolds for small cubic inch engines.	.020	.022	2500 to 5800	12-607-5	270B-6	270	280	235	242	.495	.507	106°
SOLID – Short tracks w/ small engines in heavy car. Very good torque throughout range.	.020	.022	2800 to 6200	12-608-5	280B-6	280	285	242	250	.507	.532	106°
SOLID – Very versatile cam. Great for 1/4 to 3/8 mile track.	.020	.022	3000 to 6500	12-609-5 12-609-20⁹⁴	285B-6	285	295	250	260	.532	.555	106°
SOLID – For faster 1/4 to 3/8 mile track, strong torque and quick response.	.020	.022	3500 to 6800	12-610-5 12-610-20⁹⁴	290B-4	290	304	255	266	.540	.534	104°
SOLID – Best for 1/4 to 3/8 track with fast corners. More top end than Part #12-610-5.	.020	.022	3700 to 7000	12-611-5 12-611-20⁹⁴	290B-6	290	304	255	266	.540	.534	106°
SOLID – Best for slick 3/8 to 1/2 mile track with sustained high RPM.	.020	.022	4000 to 7100	12-645-5	295B-6	295	295	260	260	.555	.555	106°
SOLID – Good for 1/2 to 5/8 mile track with light car, large engine.	.020	.022	4300 to 7300	12-612-5 12-612-20⁹⁴	300B-6	300	314	265	276	.562	.557	106°
TIGHT LASH Mechanical Flat Tappet Camshafts												
SOLID – Good short track camshaft for smaller engines, 327-350, with restrictions. 1/4 to 3/8 track with tight corners.	.018	.020	2500 to 6000	12-501-5	272TL-6	272	276	242	246	.510	.520	106°
SOLID – Use with 305-350 on 1/4 to 3/8 high banked track in heavy car with limited intake and carburetor.	.018	.020	2700 to 6200	12-511-5	272TLS-6	272	280	242	250	.510	.530	106°
SOLID – Good in 327-350 on short track with 2 BBL carburetor and cast intake.	.018	.020	2800 to 6300	12-500-5	276TL-6	276	280	246	250	.520	.530	106°
SOLID – Best on 3/8 to short 1/2 mile with high corner speeds. 350-377 engine with open rules. Good torque.	.018	.020	3000 to 6500	12-502-5	280TL-6	280	284	250	254	.530	.540	106°
SOLID – Good for 350-400 on big 3/8 to 1/2 mile tracks with high sustained RPM. Best with big carb. and good intake.	.018	.020	3000 to 6700	12-512-5	280TLS-6	280	288	250	259	.530	.550	106°
SOLID – Good baseline cam for Late Model Stock. Short 1/4-3/8 mile asphalt track. Best with 358, limited intake and carb.	.018	.020	3000 to 7000	12-504-5	284TL-6	284	284	254	254	.540	.540	106°
SOLID – Great in Late Model Stock on 3/8 to 1/2 mile asphalt track. Best in 358 with limited intake and carburetor.	.018	.020	3200 to 7000	12-505-5	284BTL-6	284	288	254	259	.540	.550	106°
SOLID – Good for 350-377 on 3/8-1/2 mile tracks with fast corners. Best with open rules.	.018	.020	3400 to 7000	12-506-5 12-506-20⁹⁴	288BTL-6	288	292	259	262	.550	.560	106°
SOLID – Best on big 3/8-1/2 mile tracks with high RPM. Great with open rules and large c.i. engines.	.018	.020	3500 to 7200	12-515-5 12-515-20⁹⁴	288TLS-6	288	296	259	266	.550	.570	106°
SOLID – For big tracks with unrestricted 377-410 engines. Best with good heads and intake.	.018	.020	3500 to 7500	12-517-5 12-517-20⁹⁴	296TLS-6	296	304	266	274	.570	.590	106°
SOLID – Use in unrestricted 400-410 engines with good heads and intake on big tracks.	.018	.020	3600 to 7600	12-519-5	304TLS-6	304	312	274	282	.590	.610	106°

² Requires machining on cylinder heads¹⁵ 50-State legal on 1993 & earlier SB Chevrolet V8, 262-400c.i. C.A.R.B. E.O. #D-279-4⁴⁸ Includes 3 cam bolts, thrust bearing, adjustable cam timing system, 2 machined steel gears & true roller chain

CHEVROLET 262-400 C.I. 8 CYL. 1958-1998 (CONTINUED)

CAMSHAFTS
GENERAL MOTORS

LIFTERS	TIMING SET	ROCKER ARMS	PUSHRODS	VALVE SPRINGS	RETAINERS	VALVE LOCKS	VALVE SEALS	LASH CAPS	REV KIT	DIST. GEAR	STUD GIRDLES
OVAL TRACK Mechanical Flat Tappet Camshafts											
813-16 800-16	3100 3100KT ⁴⁸	1601-16 ¹⁵ 1801-16 ¹⁵	7972-16	987-16 ² 978-16 ²	740-16 1730-16	611-16	503-16 ²	621-16	N/A	12200 12140	4001
813-16 800-16	3100 3100KT ⁴⁸	1601-16 ¹⁵ 1801-16 ¹⁵	7972-16	987-16 ² 978-16 ²	740-16 1730-16	611-16	503-16 ²	621-16	N/A	12200 12140	4001
813-16 800-16	3100 3100KT ⁴⁸	1601-16 ¹⁵ 1801-16 ¹⁵	7972-16	987-16 ² 978-16 ²	740-16 730-16	611-16	503-16 ²	621-16	N/A	12200 12140	4001
813-16 800-16	3100 3100KT ⁴⁸	1601-16 ¹⁵ 1801-16 ¹⁵	7972-16	987-16 ² 978-16 ²	740-16 730-16	611-16	503-16 ²	621-16	N/A	12200 12140	4001
813-16 800-16	3100 3100KT ⁴⁸	1601-16 ¹⁵ 1801-16 ¹⁵	7972-16	987-16 ² 978-16 ²	740-16 730-16	611-16	503-16 ²	621-16	N/A	12200 12140	4001
813-16 800-16	3100 3100KT ⁴⁸	1601-16 ¹⁵ 1801-16 ¹⁵	7972-16	950-16 ² 978-16 ²	740-16 730-16	611-16	503-16 ²	621-16	N/A	12200 12140	4001
813-16 800-16	3100 3100KT ⁴⁸	1601-16 ¹⁵ 1801-16 ¹⁵	7972-16	950-16 ² 978-16 ²	740-16 730-16	611-16	503-16 ²	621-16	N/A	12200 12140	4001
TIGHT LASH Mechanical Flat Tappet Camshafts											
813-16 800-16	3100 3100KT ⁴⁸	1601-16 ¹⁵ 1801-16 ¹⁵	7972-16	950-16 ² 978-16 ²	740-16 1730-16	611-16	503-16 ²	621-16	N/A	12200 12140	4001
813-16 800-16	3100 3100KT ⁴⁸	1601-16 ¹⁵ 1801-16 ¹⁵	7972-16	950-16 ² 978-16 ²	740-16 1730-16	611-16	503-16 ²	621-16	N/A	12200 12140	4001
813-16 800-16	3100 3100KT ⁴⁸	1601-16 ¹⁵ 1801-16 ¹⁵	7972-16	950-16 ² 978-16 ²	740-16 1730-16	611-16	503-16 ²	621-16	N/A	12200 12140	4001
813-16 800-16	3100 3100KT ⁴⁸	1601-16 ¹⁵ 1801-16 ¹⁵	7972-16	950-16 ² 978-16 ²	740-16 730-16	611-16	503-16 ²	621-16	N/A	12200 12140	4001
813-16 800-16	3100 3100KT ⁴⁸	1601-16 ¹⁵ 1801-16 ¹⁵	7972-16	950-16 ² 978-16 ²	740-16 730-16	611-16	503-16 ²	621-16	N/A	12200 12140	4001
813-16 800-16	3100 3100KT ⁴⁸	1601-16 ¹⁵ 1801-16 ¹⁵	7972-16	950-16 ² 978-16 ²	740-16 730-16	611-16	503-16 ²	621-16	N/A	12200 12140	4001
813-16 800-16	3100 3100KT ⁴⁸	1601-16 ¹⁵ 1801-16 ¹⁵	7972-16	950-16 ² 978-16 ²	740-16 730-16	611-16	503-16 ²	621-16	N/A	12200 12140	4001
813-16 800-16	3100 3100KT ⁴⁸	1601-16 ¹⁵ 1801-16 ¹⁵	7972-16	950-16 ² 978-16 ²	740-16 730-16	611-16	503-16 ²	621-16	N/A	12200 12140	4001
813-16 800-16	3100 3100KT ⁴⁸	1601-16 ¹⁵ 1801-16 ¹⁵	7972-16	950-16 ² 978-16 ²	740-16 730-16	611-16	503-16 ²	621-16	N/A	12200 12140	4001
813-16 800-16	3100 3100KT ⁴⁸	1601-16 ¹⁵ 1801-16 ¹⁵	7972-16	950-16 ² 978-16 ²	740-16 730-16	611-16	503-16 ²	621-16	N/A	12200 12140	4001

⁹⁴ Nitrided version



CHEVROLET 262-400 C.I. 8 CYL. 1958-1998 (CONTINUED)

APPLICATIONS/CAMSHAFTS	VALVE SETTING		RPM OPERATING RANGE	CAM PART #	CAM GRIND #	DURATION				VALVE LIFT		LOBE SEP. ANGLE
	IN.	EX.				IN.	EX.	@ .050"	IN.	EX.	W/ 1.5 ROCKER	
MAX AREA Mechanical Flat Tappet Camshafts												
SOLID – 327-350c.i., iron intake and heads. Works good with 1.7+ rockers, 1/4-3/8 mile dirt. Also good for .500" lift rule w/1.5 rockers.	.020	.022	2800 to 6000	12-620-5	263MAS-6	263	267	236	240	.497	.500	106°
SOLID – Good for Late Model Stock, 1.7 -1.8 rockers, 3/8-1/2 mile dirt or asphalt.	.020	.022	3000 to 6500	12-622-5	267MAS-6	267	275	240	248	.500	.510	106°
SOLID – Great in Late Model Stock with high rocker ratios, 1/2+ mile dirt or asphalt.	.020	.022	3200 to 6800	12-624-5	271MAS-6	271	279	244	252	.510	.510	106°
SOLID – Designed for larger tracks with fast corners, needs better intake, heads, headers and carburetor.	.020	.022	3500 to 7000	12-626-5 12-626-20⁹⁴	275MAS-6	275	283	248	256	.510	.510	106°
SOLID – 377-410 for larger tracks, likes 1.65-1.7 rockers, needs better intake, heads, headers and carburetor.	.020	.022	3500 to 7000	12-628-5 12-628-20⁹⁴	279MAS-6	279	287	252	260	.510	.510	106°
OVAL TRACK Mechanical Flat Tappet Camshafts – Xtreme Oval												
Xtreme Oval Solids use COMP's new XTQ intake profiles with the XTX exhaust profiles for more area under the curve than most good .875"lifter designs, while still allowing standard .842" lifters.												
SOLID – 1/4-3/8 tight track. 327-358c.i., 9:1 compression. 2 BBL with iron intake and exhaust.	.016	.018	2200 to 6000	12-646-5	266XOS	266	276	236	242	.501	.510	108°
SOLID – 1/4-3/8 tight. 327-358c.i., 9:1 compression. 2 BBL with stock intake and headers.	.016	.018	2500 to 6200	12-647-5	266XOS	266	272	236	238	.501	.501	108°
SOLID – 1/4-3/8 fast track. 327-358c.i., 9:1 compression. 2 BBL with iron intake and exhaust.	.016	.018	2700 to 6200	12-648-5	270XOS	270	280	240	246	.510	.519	108°
SOLID – 1/4-3/8 fast. 327-358c.i., 9:1 compression. 2 BBL with stock intake and headers.	.016	.018	2700 to 6400	12-649-5	270XOS	270	276	240	242	.510	.510	108°
SOLID – 1/4-3/8 tight track. 327-358c.i., 9:1 compression. 2 BBL, good intake and exhaust.	.016	.018	2900 to 6400	12-650-5	274XOS	274	280	244	246	.519	.519	108°
SOLID – 1/4-3/8 fast track. 327-358c.i., 9:1 compression. 2 BBL with good intake and exhaust.	.016	.018	2800 to 6600	12-651-5 12-651-20⁹⁴	278XOS	278	284	248	250	.531	.525	108°
SOLID – 1/4-3/8 tight. 327-358c.i., 11:1+ compression. 2 BBL with good intake and exhaust.	.016	.018	3000 to 6800	12-652-5 12-652-20⁹⁴	278XOS	278	284	248	250	.531	.525	106°
SOLID – 1/4-3/8 fast. 327-358c.i., 11:1+ compression. 2 BBL with good intake and exhaust.	.016	.018	3200 to 7000	12-653-5 12-653-20⁹⁴	282XOS	282	288	252	254	.540	.531	106°
SOLID – 1/4-3/8 tight. 327-358c.i., 12:1+ compression. 4 BBL with good intake and exhaust.	.016	.018	3000 to 6700	12-656-5 12-656-20⁹⁴	282XOS	282	292	252	258	.540	.537	106°
SOLID – 1/4-3/8 fast. 327-358c.i., 12:1+ compression. 4 BBL with good intake and exhaust.	.016	.018	3200 to 6900	12-657-5 12-657-20⁹⁴	286XOS	286	296	256	262	.549	.543	106°
SOLID – Late Model Stock. 1/4-3/8 track. 358 with limited intake and carb.	.016	.018	3200 to 7200	12-654-5 12-654-20⁹⁴	286XOS	286	292	256	258	.549	.537	108°
SOLID – Late Model Stock. 3/8-1/2 track. 358 with limited intake and carb.	.016	.018	3400 to 7400	12-655-5	290XOS	290	296	260	262	.558	.543	108°
SOLID – 3/8-1/2 tight. 360+c.i., 12:1+ compression. 4 BBL with good intake and exhaust.	.016	.018	3400 to 7200	12-658-5 12-658-20⁹⁴	290XOS	290	300	260	266	.558	.549	106°
SOLID – 3/8-1/2 fast. 360+c.i., 12:1+ compression. 4 BBL with good intake and exhaust.	.016	.018	3500 to 7400	12-659-5	294XOS	294	304	264	270	.567	.555	106°

² Requires machining on cylinder heads

¹⁵ 50-State legal on 1993 & earlier SB Chevrolet V8, 262-400c.i. C.A.R.B. E.O. #D-279-4

⁴⁸ Includes 3 cam bolts, thrust bearing, adjustable cam timing system, 2 machined steel gears & true roller chain



CHEVROLET 262-400 C.I. 8 CYL. 1958-1998 (CONTINUED)

APPLICATIONS/CAMSHAFTS	VALVE SETTING		RPM OPERATING RANGE	CAM PART #	CAM GRIND #	DURATION				VALVE LIFT		LOBE SEP. ANGLE
	IN.	EX.				ADVERTISED IN.	EX.	@ .050" IN.	EX.	W/ 1.5 ROCKER IN.	EX.	
OVAL TRACK 4 & 7 SWAP FIRING ORDER Mechanical Flat Tappet Camshafts												
18736542 Firing Order												
SOLID – 1/4-3/8 tight. 327-358c.i. 11:1+ compression. 2 BBL with good intake and exhaust.	.016	.018	3000 to 6800	12-688-47 12-688-20⁹⁴	47S 278XOS	278	284	248	250	.531	.525	106°
SOLID – 1/4-3/8 tight. 327-358c.i. 12:1+ compression. 4 BBL with good intake and exhaust.	.016	.018	3000 to 6700	12-689-47	47S 282XOS	282	292	252	258	.540	.537	106°
SOLID – 3/8-1/2 tight. 360+c.i. 12:1+ compression. 4 BBL with good intake and exhaust.	.016	.018	3400 to 7200	12-690-47 12-690-20⁹⁴	47S 290XOS	290	300	260	266	.558	.549	106°
APPLICATIONS/CAMSHAFTS	VALVE SETTING		RPM OPERATING RANGE	CAM PART #	CAM GRIND #	DURATION				VALVE LIFT		LOBE SEP. ANGLE
	IN.	EX.				ADVERTISED IN.	EX.	@ .050" IN.	EX.	W/ 1.8/1.7 ROCKER IN.	EX.	
OPEN WHEEL MODIFIED TRACTION CONTROL (HIGH ROCKER RATIO) Mechanical Flat Tappet Camshafts												
SOLID – 1/3-1/2 tracks w/ tight corners or heavy surface. 327-358c.i., 11:1 compression, 2/4 BBL gas or alcohol.	.016	.018	3000 to 7000	12-524-5	281JFA	281	285	252	256	.596	.563	107°
SOLID – 3/8-5/8 tracks w/ wide corners or slick surface. 355+c.i., 12:1 compression, 4 BBL gas or alcohol with good intake and heads.	.016	.018	3200 to 7200	12-525-5	285JFA	285	289	256	260	.596	.565	107°
APPLICATIONS/CAMSHAFTS	VALVE SETTING		RPM OPERATING RANGE	CAM PART #	CAM GRIND #	DURATION				VALVE LIFT		LOBE SEP. ANGLE
	IN.	EX.				ADVERTISED IN.	EX.	@ .050" IN.	EX.	W/ 1.6 ROCKER IN.	EX.	
OPEN WHEEL MODIFIED TRACTION CONTROL (1.6 ROCKER RATIO) Mechanical Flat Tappet Camshafts												
SOLID – 1/3-1/2 tracks w/ tight corners or heavy surface. 327-358c.i., 11:1 compression, 2/4 BBL gas or alcohol.	.016	.018	3100 to 7100	12-526-5 12-526-20⁹⁴	280MHQ	280	289	254	260	.590	.597	107°
SOLID – 3/8-5/8 tracks w/ wide corners or slick surface. 355+c.i., 12:1 compression, 4 BBL gas or alcohol with good intake and heads.	.016	.018	3300 to 7300	12-527-5 12-527-20⁹⁴	284MHQ	284	293	258	264	.597	.606	107°
APPLICATIONS/CAMSHAFTS	VALVE SETTING		RPM OPERATING RANGE	CAM PART #	CAM GRIND #	DURATION				VALVE LIFT		LOBE SEP. ANGLE
	IN.	EX.				ADVERTISED IN.	EX.	@ .050" IN.	EX.	W/ 1.5 ROCKER IN.	EX.	
LAUNCHER SERIES Mechanical Flat Tappet Camshafts												
SOLID – .283" lobe lift – Good for short track restricted with .425" or .450" lift rule.	.014	.014	3000 to 6600	12-680-5	LA2695	269	273	242	246	.425	.425	107°
SOLID – .283" lobe lift – Good for higher RPM tracks restricted with .425" or .450" lift rule.	.014	.014	3200 to 6800	12-681-5	LA2735	273	277	246	250	.425	.425	107°
SOLID – .312" lobe lift – Good for short track restricted with .480" or .500" lift rule.	.014	.014	3000 to 6600	12-682-5	LB2705	270	274	244	248	.468	.468	107°
SOLID – .312" lobe lift – Good for higher RPM tracks restricted with .480" or .500" lift rule.	.014	.014	3200 to 6800	12-683-5	LB2745	274	278	248	252	.468	.468	107°
SOLID – .322" lobe lift – Good for short track restricted with stock rocker and .480" or .500" lift rule.	.014	.014	2800 to 6400	12-684-5	LC2705	270	274	244	248	.483	.483	107°
SOLID – .322" lobe lift – Good for longer tracks, restricted carb. W/ stock rocker & .480" or .500" lift rule.	.014	.014	3000 to 6600	12-685-5	LC2745	274	278	248	252	.483	.483	107°
LOW LIFT OVAL TRACK Mechanical Flat Tappet Camshaft												
SOLID – .470" lift rule. Rough idle. Low vacuum.	.018	.018	2500 to 6000	12-523-5	270S-6	270	282	242	250	.473	.473	106°

² Requires machining on cylinder heads

¹⁵ 50-State legal on 1993 & earlier SB Chevrolet V8, 262-400c.i. C.A.R.B. E.O. #D-279-4

⁴⁸ Includes 3 cam bolts, thrust bearing, adjustable cam timing system, 2 machined steel gears & true roller chain

CHEVROLET 262-400 C.I. 8 CYL. 1958-1998 (CONTINUED)

LIFTERS	TIMING SET	ROCKER ARMS	PUSHRODS	VALVE SPRINGS	RETAINERS	VALVE LOCKS	VALVE SEALS	LASH CAPS	REV KIT	DIST. GEAR	STUD GIRDLES
OVAL TRACK 4 & 7 SWAP FIRING ORDER Mechanical Flat Tappet Camshafts											
813-16 800-16	3100 3100KT ⁴⁸	1601-16 ¹⁵ 1801-16 ¹⁵	7372-16 7972-16	950-16 ² 978-16 ²	740-16 730-16	611-16	503-16 ²	621-16	N/A	12200 12140	4001
813-16 800-16	3100 3100KT ⁴⁸	1601-16 ¹⁵ 1801-16 ¹⁵	7372-16 7972-16	950-16 ² 978-16 ²	740-16 730-16	611-16	503-16 ²	621-16	N/A	12200 12140	4001
813-16 800-16	3100 3100KT ⁴⁸	1601-16 ¹⁵ 1801-16 ¹⁵	7372-16 7972-16	950-16 ² 26094-16 ²	740-16 732/721	611-16	503-16 ²	621-16	N/A	12200 12140	4001
OPEN WHEEL MODIFIED TRACTION CONTROL (HIGH ROCKER RATIO) Mechanical Flat Tappet Camshafts											
800-16	3100KT ⁴⁸ 7100	1818-8 ⁵⁹ 1817-8 ⁵⁹	7913-16	26094-16 ² 26075-16 ²	732-16 738-16	611-16 614-16	503-16 ²	621-16	N/A	12200 12140	4004
800-16	3100KT ⁴⁸ 7100	1818-8 ⁵⁹ 1817-8 ⁵⁹	7913-16	26094-16 ² 26075-16 ²	732-16 738-16	611-16 614-16	503-16 ²	621-16	N/A	12200 12140	4004
OPEN WHEEL MODIFIED TRACTION CONTROL (1.6 ROCKER RATIO) Mechanical Flat Tappet Camshafts											
800-16	3100KT ⁴⁸ 7100	1605-16 ⁵⁹ 1805-16 ⁵⁹	7913-16	26094-16 ² 26075-16 ²	732-16 738-16	611-16	503-16 ²	621-16	N/A	12200 12140	4004
800-16	3100KT ⁴⁸ 7100	1605-16 ⁵⁹ 1805-16 ⁵⁹	7913-16	26094-16 ² 26075-16 ²	732-16 738-16	611-16	503-16 ²	621-16	N/A	12200 12140	4004
LAUNCHER SERIES Mechanical Flat Tappet Camshafts											
813-16 800-16	3100 3100KT ⁴⁸	1604-16 ⁵⁹ 1804-16 ⁵⁹	7913-16	941-16 26918-16	750-16 795-16	611-16 614-16	503-16 ²	621-16	N/A	12200 12140	4004 ⁵⁹
813-16 800-16	3100 3100KT ⁴⁸	1604-16 ⁵⁹ 1804-16 ⁵⁹	7913-16	941-16 26918-16	750-16 795-16	611-16 614-16	503-16 ²	621-16	N/A	12200 12140	4004 ⁵⁹
813-16 800-16	3100 3100KT ⁴⁸	1604-16 ⁵⁹ 1804-16 ⁵⁹	7913-16	941-16 26918-16	750-16 795-16	611-16 614-16	503-16 ²	621-16	N/A	12200 12140	4004 ⁵⁹
813-16 800-16	3100 3100KT ⁴⁸	1604-16 ⁵⁹ 1804-16 ⁵⁹	7913-16	941-16 26918-16	750-16 795-16	611-16 614-16	503-16 ²	621-16	N/A	12200 12140	4004 ⁵⁹
813-16 800-16	3100 3100KT ⁴⁸	1604-16 ⁵⁹ 1804-16 ⁵⁹	7913-16	941-16 26918-16	750-16 795-16	611-16 614-16	503-16 ²	621-16	N/A	12200 12140	4004 ⁵⁹
813-16 800-16	3100 3100KT ⁴⁸	1604-16 ⁵⁹ 1804-16 ⁵⁹	7913-16	941-16 26918-16	750-16 795-16	611-16 614-16	503-16 ²	621-16	N/A	12200 12140	4004 ⁵⁹
LOW LIFT OVAL TRACK Mechanical Flat Tappet Camshaft											
813-16 800-16	3100 3100KT ⁴⁸	1601-16 ¹⁵ 1801-16 ¹⁵	7372-16 7972-16	983-16 26981-16	751-16 795-16	611-16 614-16	501-16 503-16 ²	621-16	N/A	12200 12140	4001

⁵⁹ Requires 7/16" rocker arm studs

⁹⁴ Nitrided version



CHEVROLET 262-400 C.I. 8 CYL. 1958-1998 (CONTINUED)

APPLICATIONS/CAMSHAFTS	VALVE SETTING		RPM OPERATING RANGE	CAM PART #	CAM GRIND #	DURATION				VALVE LIFT		LOBE SEP. ANGLE
	IN.	EX.				ADVERTISED IN.	EX.	@ .050" IN.	EX.	W/ 1.5 ROCKER IN.	EX.	
MAGNUM Mechanical Roller Camshafts												
MECHANICAL ROLLER – Most versatile, good vacuum, excellent throttle response, noticeable idle, works well with stock manifolds and 2000+ stall.	.020	.020	2000 to 6000	12-700-8 ^{10,46}	268AR	268	268	224	224	.525	.525	110°
MECHANICAL ROLLER – Street/strip performance. Choppy idle, use 2500+ stall and headers. 9.5:1 compression.	.020	.020	2500 to 6500	12-702-8 ^{10,46}	280AR	280	280	236	236	.550	.550	110°
MECHANICAL ROLLER – Excellent choice for maximum street effort, racy idle, 3500+ stall with low gears, 10:1 compression and headers.	.020	.020	3000 to 7000	12-705-8 ^{10,46}	300AR	300	300	255	255	.575	.575	110°
XTREME ENERGY™ Mechanical Roller Camshafts												
MECHANICAL ROLLER – Good for weekend cruiser with 9:1+ compression, 2000+ stall and lower gears. Noticeable idle.	.016	.018	2000 to 6000	12-769-8 ^{10,46}	XR268R	268	274	230	236	.552	.564	110°
MECHANICAL ROLLER – Great for power touring. Needs 2500+ stall, easy on parts. Rough idle.	.016	.018	2200 to 6200	12-770-8 ^{10,46}	XR274R	274	280	236	242	.564	.570	110°
MECHANICAL ROLLER – Best in street machines with 2800+ stall, 10:1+ compression with 3.73-3.90 rear gears.	.016	.018	2500 to 6500	12-771-8 ^{10,46}	XR280R	280	286	242	248	.570	.576	110°
MECHANICAL ROLLER – Good in weekend warrior with 3000+ stall. Needs good intake and exhaust with low gears.	.016	.018	3000 to 7000	12-772-8 ^{10,46}	XR286R	286	292	248	254	.576	.582	110°
MECHANICAL ROLLER – Best for Pro Street. Needs good intake & exhaust, 11:1+ compression & 3500 stall.	.016	.018	3200 to 7200	12-773-8 ^{10,46}	XR292R	292	297	254	260	.582	.588	110°
BLOWER Mechanical Roller Camshafts												
MECHANICAL ROLLER – Good for serious street/strip applications with 671 blower.	.020	.020	3000 to 6500	12-704-8 ¹⁰	300BR-14	300	308	255	262	.575	.575	114°
PULLER & MUD RACE Mechanical Roller Camshafts												
MECHANICAL ROLLER – Good for 350-370 engine when maximum torque is needed. 10:1+ compression.	.026	.028	3500 to 6900	12-900-9 ¹⁴	288AR-6	288	296	252	258	.630	.630	106°
MECHANICAL ROLLER – Good for 377-406 engine with carburetor or injectors. 11:1 compression.	.026	.028	4500 to 7200	12-903-9 ¹⁴	300AR-6	300	304	264	266	.630	.630	106°
DRAG RACE Mechanical Roller Camshafts												
MECHANICAL ROLLER – Great torque, 10:1+ compression, 3500+ stall. Good for 350-370c.i.	.026	.028	3200 to 6200	12-900-9 ¹⁴	288AR-6	288	296	252	258	.630	.630	106°
MECHANICAL ROLLER – 4500+ stall, 11:1 compression, lower gears needed.	.026	.028	4200 to 7200	12-908-9 ¹⁴	300BR-6	300	308	264	270	.630	.630	106°
MECHANICAL ROLLER – Super Stock 350 auto w/ 1.8 and 1.6.	.026	.028	5500 to 8000	12-813-9 ¹⁴	306LHR-7	306	312	274	284	.748	.704	107°
MECHANICAL ROLLER – Bracket with good heads and small Comp Eliminator 1.6 and 1.6.	.026	.028	4500 to 8500	12-817-9 ¹⁴	307RXD-12	307	320	274	282	.739	.739	112°

² Requires machining on cylinder heads
⁶ Offset lifters available

⁷ Stock springs cannot be used
¹⁰ Requires thrust button & wear plate

¹⁴ Requires upgraded gear, thrust button & wear plate

CHEVROLET 262-400 C.I. 8 CYL. 1958-1998 (CONTINUED)

CAMSHAFTS GENERAL MOTORS

K-KIT	CL-KIT	RP-KIT	LIFTERS	DIST. GEAR	TIMING SET	ROCKER ARMS	PUSHRODS	VALVE SPRINGS	RETAINERS	VALVE LOCKS	VALVE SEALS
MAGNUM Mechanical Roller Camshafts											
K12-700-8	CL12-700-8 ^{7,10}	RPM1601-16 RPM1801-16	818-16 ⁶ 98818-16 ⁶	412M	2100 7100	1601-16 ¹⁵ 1801-16 ¹⁵	7372-16 7972-16	977-16 ² 26055-16 ²	740-16 785-16	611-16	503-16 ²
K12-702-8	CL12-702-8 ^{7,10}	RPM1601-16 RPM1801-16	818-16 ⁶ 98818-16 ⁶	412M	2100 7100	1601-16 ¹⁵ 1801-16 ¹⁵	7372-16 7972-16	977-16 ² 26055-16 ²	740-16 785-16	611-16	503-16 ²
K12-705-8	CL12-705-8 ^{7,10}	RPM1601-16 RPM1801-16	818-16 ⁶ 98818-16 ⁶	412M	2100 7100	1601-16 ¹⁵ 1801-16 ¹⁵	7372-16 7972-16	977-16 ² 26055-16 ²	740-16 785-16	611-16	503-16 ²
XTREME ENERGY™ Mechanical Roller Camshafts											
K12-769-8	CL12-769-8 ^{7,10}	RPM1601-16 RPM1801-16	818-16 ⁶ 98818-16 ⁶	412M	2100 7100	1601-16 ¹⁵ 1801-16 ¹⁵	7372-16 7972-16	977-16 ² 26055-16 ²	740-16 785-16	611-16	503-16 ²
K12-770-8	CL12-770-8 ^{7,10}	RPM1601-16 RPM1801-16	818-16 ⁶ 98818-16 ⁶	412M	2100 7100	1601-16 ¹⁵ 1801-16 ¹⁵	7372-16 7972-16	977-16 ² 26055-16 ²	740-16 785-16	611-16	503-16 ²
K12-771-8	CL12-771-8 ^{7,10}	RPM1601-16 RPM1801-16	818-16 ⁶ 98818-16 ⁶	412M	2100 7100	1601-16 ¹⁵ 1801-16 ¹⁵	7372-16 7972-16	977-16 ² 26055-16 ²	740-16 785-16	611-16	503-16 ²
K12-772-8	CL12-772-8 ^{7,10}	RPM1601-16 RPM1801-16	818-16 ⁶ 98818-16 ⁶	412M	2100 7100	1601-16 ¹⁵ 1801-16 ¹⁵	7372-16 7972-16	977-16 ² 26055-16 ²	740-16 785-16	611-16	503-16 ²
K12-773-8	CL12-773-8 ^{7,10}	RPM1601-16 RPM1801-16	818-16 ⁶ 98818-16 ⁶	412M	2100 7100	1601-16 ¹⁵ 1801-16 ¹⁵	7372-16 7972-16	977-16 ² 26055-16 ²	740-16 785-16	611-16	503-16 ²
LIFTERS	TIMING SET	ROCKER ARMS	PUSHRODS	VALVE SPRINGS	RETAINERS	VALVE LOCKS	VALVE SEALS	LASH CAPS	REV KIT	DIST. GEAR	STUD GIRDLES
BLOWER Mechanical Roller Camshafts											
818-16 ⁶ 98818-16 ⁶	3100KT ⁴⁸ 6500	1601-16 ¹⁵ 1801-16 ¹⁵	7372-16 7972-16	977-16 ² 26055-16 ²	740-16 785-16	611-16 614-16	503-16 ²	621-16	4000	412M	4001
PULLER & MUD RACE Mechanical Roller Camshafts											
818-16 ⁶ 98818-16 ⁶	3100KT ⁴⁸ 6500	1601-16 ¹⁵ 1801-16 ¹⁵	7372-16 7972-16	977-16 ² 26055-16 ²	740-16 785-16	611-16 614-16	503-16 ²	621-16	4000	12200	4004 ⁵⁹
818-16 ⁶ 98818-16 ⁶	3100KT ⁴⁸	1601-16 ¹⁵ 1801-16 ¹⁵	7972-16	943-16 ² 26089-16 ²	731-16 720-16	611-16 614-16	503-16 ²	621-16	4000	12200	4004 ⁵⁹
DRAG RACE Mechanical Roller Camshafts											
818-16 ⁶ 98818-16 ⁶	3100KT ⁴⁸ 6500	1604-16 ⁵⁹ 1804-16 ⁵⁹	7972-16	954-16 ² 944-16 ²	732-16 731-16	611-16 614-16	503-16 ²	621-16	4000	12200	4004 ⁵⁹
818-16 ⁶ 98818-16 ⁶	3100KT ⁴⁸ 6500	1604-16 ⁵⁹ 1804-16 ⁵⁹	7972-16	954-16 ² 944-16 ²	732-16 731-16	611-16 614-16	503-16 ²	621-16	4000	12200	4004 ⁵⁹
98818-16 ⁶	3100KT ⁴⁸ 6500	1818-8 ⁵⁹ 1805-8 ⁵⁹	7913-16	947-16 ² 26082-16 ²	735-16 722-16	611-16 614-16	506-16 ²	621-16	4000	12200	4004 ⁵⁹
98818-16 ⁶	3100KT ⁴⁸ 6500	1605-16 ⁵⁹ 1805-16 ⁵⁹	7913-16	947-16 ² 26082-16 ²	735-16 722-16	611-16 614-16	506-16 ²	621-16	4000	12200	4004 ⁵⁹

¹⁵ 50-State legal on 1993 & earlier SB Chevrolet V8, 262-400c.i. C.A.R.B. E.O. #D-279-4

⁴⁶ Must use bronze tip fuel pump pushrod when using high pressure or high volume pump

⁴⁸ Includes 3 cam bolts, thrust bearing, adjustable cam timing system, 2 machined steel gears & true roller chain

⁵⁹ Requires 7/16" rocker arm studs

RED NUMBERS DENOTE PREMIUM OPTION



CHEVROLET 262-400 C.I. 8 CYL. 1958-1998 (CONTINUED)

APPLICATIONS/CAMSHAFTS	VALVE SETTING		RPM OPERATING RANGE	CAM PART #	CAM GRIND #	DURATION				VALVE LIFT		LOBE SEP. ANGLE
	IN.	EX.				ADVERTISED IN.	EX.	@ .050" IN.	EX.	W/ 1.5 ROCKER IN.	EX.	
DRAG RACE Mechanical Roller Camshafts												
MECHANICAL ROLLER – Latest design for 350 with race heads, 5500+ stall.	.016	.018	4500 to 7800	12-865-9^{14, 46}	307-R6	307	317	278	284	.684	.660	106°
MECHANICAL ROLLER – Latest design for 350 with race heads, 5500+ stall, 1.8 & 1.7 rockers.	.016	.018	5000 to 8000	12-866-9^{14, 46}	305HXL-6	305	313	276	284	.819	.660	106°
MECHANICAL ROLLER – Comp Eliminator or Fast Bracket with 1.8 and 1.7.	.026	.028	4800 to 8500	12-818-9^{14, 46}	310RXD-14	310	334	277	296	.846	.800	114°
MECHANICAL ROLLER – 5000+ stall, 11:1+ compression.	.026	.028	4500 to 7500	12-906-9^{14, 46}	312AR-7	312	322	276	284	.630	.630	107°
MECHANICAL ROLLER – 350-400, 5000+ stall, 11.5:1+ compression, ported heads.	.026	.028	4500 to 7500	12-801-9^{14, 46}	313R-6	313	322	276	284	.660	.630	106°
MECHANICAL ROLLER – Small cubic inch high RPM with 1.7 and 1.6.	.024	.026	6000 to 10000	12-814-9^{14, 46}	314CER-14	314	335	278	294	.824	.739	114°
MECHANICAL ROLLER – Large Comp Eliminator or Fast Bracket w/ 1.8 and 1.7.	.026	.028	5000 to 9000	12-819-9^{14, 46}	314RXD-14	314	334	281	296	.873	.800	114°
MECHANICAL ROLLER – 355+ c.i., 4 speed, light car.	.026	.028	5200 to 7800	12-907-9^{14, 46}	316AR-8	316	326	280	288	.630	.630	108°
MECHANICAL ROLLER – 355+ c.i., ported head, 5500+ stall, in light car.	.026	.028	5500 to 7800	12-726-9^{14, 46}	317DR-6	317	330	280	292	.660	.630	106°
MECHANICAL ROLLER – Medium cubic inch Comp Eliminator w/ 1.8 and 1.7.	.024	.026	6000 to 10000	12-815-9^{14, 46}	318CER-14	318	339	282	298	.873	.785	114°
MECHANICAL ROLLER – Large cubic inch Quick 16 or Fast Bracket with 1.8 and 1.7.	.026	.028	5200 to 9200	12-820-9^{14, 46}	318RXD-14	318	338	285	300	.873	.800	114°
DRAG RACE Mechanical Roller Camshafts (.900" Base Circle)												
MECHANICAL ROLLER – 400+ c.i., good heads, high compression, .900" base circle.	.024	.026	5000 to 7500	12-970-9^{14, 46}	312R-8	312	325	279	286	.679	.645	108°
MECHANICAL ROLLER – 355+ c.i., ported head, 5500+ stall in light car, .900" base circle.	.026	.028	5500 to 7800	12-727-9^{14, 46}	317ER-6	317	330	280	292	.660	.630	106°
DRAG RACE 4 & 7 SWAP FIRING ORDER Mechanical Roller Camshafts												
(18736542 Firing Order)												
MECHANICAL ROLLER – Great torque, 10:1+ compression, 4000+ stall.	.020	.022	4000 to 7000	12-823-14¹⁴	47S 288R-6	288	296	252	258	.630	.630	106°
MECHANICAL ROLLER – 4500+ stall, 11:1+ compression and good heads.	.024	.026	4200 to 7200	12-822-14¹⁴	47S 300R-6	300	308	264	270	.630	.630	106°
MECHANICAL ROLLER – 5000+ stall, 11:1+ compression, good mid and top end.	.020	.022	4500 to 7500	12-824-14¹⁴	47S 312R-7	312	322	276	284	.630	.630	107°
DRAG RACE 4 & 7 SWAP FIRING ORDER Mechanical Roller Camshafts (.900" Base Circle)												
(18736542 Firing Order)												
MECHANICAL ROLLER – 400+ c.i. engines, good heads, high compression, .900" base circle.	.024	.026	5000 to 7500	12-821-14¹⁴	47S 312R-8	312	325	279	286	.679	.645	108°

² Requires machining on cylinder heads
⁶ Offset lifters available

¹⁴ Requires upgraded gear, thrust button & wear plate

⁴⁶ Must use bronze tip fuel pump pushrod when using high pressure or high volume pump

CHEVROLET 262-400 C.I. 8 CYL. 1958-1998 (CONTINUED)

CAMSHAFTS GENERAL MOTORS

LIFTERS	TIMING SET	ROCKER ARMS	PUSHRODS	VALVE SPRINGS	RETAINERS	VALVE LOCKS	VALVE SEALS	LASH CAPS	REV KIT	DIST. GEAR	STUD GIRDLES
DRAG RACE Mechanical Roller Camshafts											
98818-16 ⁶	3100KT ⁴⁸ 6500	1604-16 ⁵⁹ 1804-16 ⁵⁹	7972-16	944-16 ² 26115-16 ²	731-16 732-16	611-16 614-16	503-16 ²	621-16	4000	12200	4004 ⁵⁹
98818-16 ⁶	3100KT ⁴⁸ 6500	1818-8 ⁵⁹ 1817-8 ⁵⁹	7913-16	26082-16 ² 26028-16 ²	735-16 722-16	611-16 614-16	506-16 ²	621-16	4000	12200	4004 ⁵⁹
98818-16 ⁶	3100KT ⁴⁸ 6500	1818-8 ⁵⁹ 1817-8 ⁵⁹	7913-16	26082-16 ² 26028-16 ²	735-16 722-16	611-16 614-16	506-16 ²	621-16	4000	12200	4004 ⁵⁹
818-16 ⁶ 98818-16 ⁶	3100KT ⁴⁸ 6500	1604-16 ⁵⁹ 1804-16 ⁵⁹	7972-16	954-16 ² 944-16 ²	732-16 731-16	611-16 614-16	506-16 ²	621-16	4000	12200	4004 ⁵⁹
98818-16 ⁶	3100KT ⁴⁸ 6500	1604-16 ⁵⁹ 1804-16 ⁵⁹	7972-16	954-16 ² 944-16 ²	732-16 731-16	611-16 614-16	506-16 ²	621-16	4000	12200	4004 ⁵⁹
98818-16 ⁶	3100KT ⁴⁸ 6500	1817-8 ⁵⁹ 1805-8 ⁵⁹	7913-16	26082-16 ² 26028-16 ²	735-16 722-16	611-16 614-16	506-16 ²	621-16	4000	12200	4004 ⁵⁹
98818-16 ⁶	3100KT ⁴⁸ 6500	1818-8 ⁵⁹ 1817-8 ⁵⁹	7913-16	26082-16 ² 26028-16 ²	735-16 722-16	611-16 614-16	506-16 ²	621-16	4000	12200	4004 ⁵⁹
818-16 ⁶ 98818-16 ⁶	3100KT ⁴⁸ 6500	1604-16 ⁵⁹ 1804-16 ⁵⁹	7972-16	944-16 ² 26115-16 ²	731-16 732-16	611-16 614-16	503-16 ²	621-16	4000	12200	4004 ⁵⁹
818-16 ⁶	3100KT ⁴⁸ 6500	1604-16 ⁵⁹ 1804-16 ⁵⁹	7972-16	944-16 ² 26115-16 ²	731-16 732-16	611-16 614-16	503-16 ²	621-16	4000	12200	4004 ⁵⁹
818-16 ⁶	3100KT ⁴⁸ 6500	1818-8 ⁵⁹ 1817-8 ⁵⁹	7913-16	26082-16 ² 26028-16 ²	735-16 722-16	611-16 614-16	506-16 ²	621-16	4000	12200	4004 ⁵⁹
818-16 ⁶	3100KT ⁴⁸ 6500	1818-8 ⁵⁹ 1817-8 ⁵⁹	7913-16	26082-16 ² 26028-16 ²	735-16 722-16	611-16 614-16	506-16 ²	621-16	4000	12200	4004 ⁵⁹
DRAG RACE Mechanical Roller Camshafts (.900" Base Circle)											
818-16 ⁶	3100KT ⁴⁸ 6500	1604-16 ⁵⁹ 1804-16 ⁵⁹	7972-16	944-16 ² 26115-16 ²	732-16 721-16	611-16 614-16	503-16 ²	621-16	4000	12200	4004 ⁵⁹
818-16 ⁶	3100KT ⁴⁸ 6500	1604-16 ⁵⁹ 1804-16 ⁵⁹	7972-16	944-16 ² 26115-16 ²	732-16 721-16	611-16 614-16	503-16 ²	621-16	4000	12200	4004 ⁵⁹
DRAG RACE 4 & 7 SWAP FIRING ORDER Mechanical Roller Camshafts											
818-16 ⁶	3100KT ⁴⁸ 6500	1604-16 ⁵⁹ 1804-16 ⁵⁹	7972-16	954-16 ² 944-16 ²	732-16 731-16	611-16 614-16	506-16 ²	621-16	4000	12200	4004 ⁵⁹
818-16 ⁶	3100KT ⁴⁸ 6500	1604-16 ⁵⁹ 1804-16 ⁵⁹	7972-16	954-16 ² 944-16 ²	732-16 731-16	611-16 614-16	506-16 ²	621-16	4000	12200	4004 ⁵⁹
818-16 ⁶	3100KT ⁴⁸ 6500	1604-16 ⁵⁹ 1804-16 ⁵⁹	7972-16	954-16 ² 944-16 ²	732-16 731-16	611-16 614-16	506-16 ²	621-16	4000	12200	4004 ⁵⁹
DRAG RACE 4 & 7 SWAP FIRING ORDER Mechanical Roller Camshafts (.900" Base Circle)											
818-16 ⁶	3100KT ⁴⁸ 6500	1604-16 ⁵⁹ 1804-16 ⁵⁹	7972-16	944-16 ² 26115-16 ²	732-16 721-16	611-16 614-16	503-16 ²	621-16	4000	12200	4004 ⁵⁹

⁴⁸ Includes 3 cam bolts, thrust bearing, adjustable cam timing system, 2 machined steel gears & true roller chain

⁵⁹ Requires 7/16" rocker arm studs

RED NUMBERS DENOTE PREMIUM OPTION



CHEVROLET 262-400 C.I. 8 CYL. 1958-1998 (CONTINUED)

APPLICATIONS/CAMSHAFTS	VALVE SETTING		RPM OPERATING RANGE	CAM PART #	CAM GRIND #	DURATION				VALVE LIFT		LOBE SEP. ANGLE
	IN.	EX.				IN.	EX.	@ .050"	IN.	EX.	W/ 1.5 ROCKER	
OVAL TRACK Mechanical Roller Camshafts (Standard Base Circle)												
MECHANICAL ROLLER – Best for heavy cars and small engines on short tracks.	.020	.022	3200 to 6200	12-900-9 ^{14, 46}	288AR-6	288	296	252	258	.630	.630	106°
MECHANICAL ROLLER – Good for 1/4 to 3/8 mile tacky tracks with tight corners.	.020	.022	3500 to 6500	12-901-9 ^{14, 46}	292AR-6	292	296	256	258	.630	.630	106°
MECHANICAL ROLLER – Good torque and throttle response w/ 355 engine on short track.	.020	.022	3600 to 6600	12-902-9 ^{14, 46}	296AR-6	296	300	260	262	.630	.630	106°
MECHANICAL ROLLER – 355 in Late Model with good heads and intake on 1/4 to 3/8 mile tracks.	.020	.022	3000 to 7000	12-940-9 ^{14, 46}	290AR-6	290	300	260	264	.645	.630	106°
MECHANICAL ROLLER – More aggressive intake lobe, more torque. Good for sprint car.	.020	.022	3800 to 7000	12-910-9 ^{14, 46}	288BR-6	288	300	260	264	.660	.630	106°
MECHANICAL ROLLER – Good Late Model cam w/ 388-406 on short track.	.020	.022	4200 to 7000	12-909-9 ^{14, 46}	296BR-4	296	304	260	266	.630	.630	104°
MECHANICAL ROLLER – Good cam for sprint car on longer tracks.	.020	.022	4000 to 7000	12-911-9 ^{14, 46}	288CR-6	288	304	260	268	.660	.630	106°
MECHANICAL ROLLER – Best cam for Late Model with 406+ engine.	.020	.022	4200 to 7200	12-903-9 ^{14, 46}	300AR-6	300	304	264	266	.630	.630	106°
MECHANICAL ROLLER – High torque cam for use with 1.6 or 1.65 intake rocker.	.020	.022	4200 to 7000	12-835-9 ^{14, 46}	296CR-6	296	304	264	268	.609	.630	106°
MECHANICAL ROLLER – 355 Late Model with good cylinder heads on longer tracks.	.020	.022	3500 to 7500	12-945-9 ^{14, 46}	294AR-6	294	304	264	268	.645	.630	106°
MECHANICAL ROLLER – Best torque in 406+ Late Model or 355, 9:1 compression.	.020	.022	4500 to 7500	12-912-9 ^{14, 46}	292BR-6	292	304	264	268	.660	.630	106°
MECHANICAL ROLLER – Good Late Model with large engine and slick track.	.020	.022	4500 to 7500	12-830-9 ^{14, 46}	292CR-6	292	308	264	272	.660	.630	106°
MECHANICAL ROLLER – 400-410 Late Model on 3/8 to 5/8 mile tracks.	.020	.022	3500 to 7500	12-950-9 ^{14, 46}	296DR-6	296	308	266	272	.645	.630	106°
MECHANICAL ROLLER – Good for 311-355 with open carb. Good on road course.	.020	.022	5000 to 8200	12-905-9 ^{14, 46}	308AR-7	308	312	272	274	.630	.630	107°
MECHANICAL ROLLER – Excellent for 12:1 compression, 358 with open carb. Sustained high RPM on long track.	.020	.022	6200 to 8500	12-906-9 ^{14, 46}	312AR-7	312	322	276	284	.630	.630	107°
OVAL TRACK Mechanical Roller Camshafts												
Xtreme TK Rollers give more area under the curve and shorter seat timing than any other series. Great for Hi-Torque or restricted applications.												
MECHANICAL ROLLER – 1/4-3/8. 331-355 limited Late Model, restricted with 2 BBL carb.	.016	.016	2800 to 7000	12-854-9 ^{14, 46}	279TKR-6	279	283	251	255	.645	.645	106°
MECHANICAL ROLLER – 1/4-3/8. 331-355 limited Late Model, 2 BBL and 390 4 BBL carbs.	.016	.016	3000 to 7200	12-855-9 ^{14, 46}	281TKR-6	281	285	253	257	.645	.645	106°
MECHANICAL ROLLER – 355-377 Sportsman, Late Model. Great torque with gear rule.	.016	.020	3200 to 7400	12-856-9 ^{14, 46}	281TKBR-6	281	295	253	262	.645	.630	106°
MECHANICAL ROLLER – 1/4-1/2 mile tacky. 355-377 Late Model with 4 BBL, big heads.	.016	.016	3500 to 7500	12-857-9 ^{14, 46}	283TKR-6	283	287	255	259	.645	.645	106°

² Requires machining on cylinder heads
⁶ Offset lifters available

¹⁴ Requires upgraded gear, thrust button & wear plate

⁴⁶ Must use bronze tip fuel pump pushrod when using high pressure or high volume pump

CHEVROLET 262-400 C.I. 8 CYL. 1958-1998 (CONTINUED)

CAMSHAFTS GENERAL MOTORS

LIFTERS	TIMING SET	ROCKER ARMS	PUSHRODS	VALVE SPRINGS	RETAINERS	VALVE LOCKS	VALVE SEALS	LASH CAPS	REV KIT	DIST. GEAR	STUD GIRDLES	
OVAL TRACK Mechanical Roller Camshafts (Standard Base Circle)												
818-16 ⁶ 98818-16 ⁶	3100KT ⁴⁸ 7100	1604-16 ⁵⁹ 1804-16 ⁵⁹	7972-16 7913-16	943-16 ² 26089-16 ²	731-16 720-16	611-16 614-16	503-16 ²	621-16	4000	12200	4004 ⁵⁹	
818-16 ⁶ 98818-16 ⁶	3100KT ⁴⁸ 7100	1604-16 ⁵⁹ 1804-16 ⁵⁹	7972-16 7913-16	943-16 ² 26089-16 ²	731-16 720-16	611-16 614-16	503-16 ²	621-16	4000	12200	4004 ⁵⁹	
98818-16 ⁶	3100KT ⁴⁸ 7100	1604-16 ⁵⁹ 1804-16 ⁵⁹	7972-16 7913-16	943-16 ² 26089-16 ²	731-16 720-16	611-16 614-16	503-16 ²	621-16	4000	12200	4004 ⁵⁹	
98818-16 ⁶	3100KT ⁴⁸ 7100	1604-16 ⁵⁹ 1804-16 ⁵⁹	7972-16 7913-16	943-16 ² 26089-16 ²	731-16 720-16	611-16 614-16	503-16 ²	621-16	4000	12200	4004 ⁵⁹	
98818-16 ⁶	3100KT ⁴⁸ 7100	1604-16 ⁵⁹ 1804-16 ⁵⁹	7972-16 7913-16	943-16 ² 26089-16 ²	731-16 720-16	611-16 614-16	503-16 ²	621-16	4000	12200	4004 ⁵⁹	
818-16 ⁶ 98818-16 ⁶	3100KT ⁴⁸ 7100	1604-16 ⁵⁹ 1804-16 ⁵⁹	7972-16 7913-16	943-16 ² 26089-16 ²	731-16 720-16	611-16 614-16	503-16 ²	621-16	4000	12200	4004 ⁵⁹	
98818-16 ⁶	3100KT ⁴⁸ 7100	1604-16 ⁵⁹ 1804-16 ⁵⁹	7972-16 7913-16	943-16 ² 26089-16 ²	731-16 720-16	611-16 614-16	503-16 ²	621-16	4000	12200	4004 ⁵⁹	
818-16 ⁶ 98818-16 ⁶	3100KT ⁴⁸ 7100	1604-16 ⁵⁹ 1804-16 ⁵⁹	7972-16 7913-16	943-16 ² 26089-16 ²	731-16 720-16	611-16 614-16	503-16 ²	621-16	4000	12200	4004 ⁵⁹	
98818-16 ⁶	3100KT ⁴⁸ 7100	1604-16 ⁵⁹ 1804-16 ⁵⁹	7972-16 7913-16	943-16 ² 26089-16 ²	731-16 720-16	611-16 614-16	503-16 ²	621-16	4000	12200	4004 ⁵⁹	
98818-166	3100KT ⁴⁸ 7100	1604-16 ⁵⁹ 1804-16 ⁵⁹	7972-16 7913-16	943-16 ² 26089-16 ²	731-16 720-16	611-16 614-16	503-16 ²	621-16	4000	12200	4004 ⁵⁹	
98818-16 ⁶	3100KT ⁴⁸ 7100	1604-16 ⁵⁹ 1804-16 ⁵⁹	7972-16 7913-16	943-16 ² 26089-16 ²	731-16 720-16	611-16 614-16	503-16 ²	621-16	4000	12200	4004 ⁵⁹	
98818-166	3100KT ⁴⁸ 7100	1604-16 ⁵⁹ 1804-16 ⁵⁹	7972-16 7913-16	943-16 ² 26089-16 ²	731-16 720-16	611-16 614-16	503-16 ²	621-16	4000	12200	4004 ⁵⁹	
98818-16 ⁶	3100KT ⁴⁸ 7100	1604-16 ⁵⁹ 1804-16 ⁵⁹	7972-16 7913-16	943-16 ² 26089-16 ²	731-16 720-16	611-16 614-16	503-16 ²	621-16	4000	12200	4004 ⁵⁹	
98818-16 ⁶	3100KT ⁴⁸ 7100	1604-16 ⁵⁹ 1804-16 ⁵⁹	7972-16 7913-16	943-16 ² 26089-16 ²	731-16 720-16	611-16 614-16	503-16 ²	621-16	4000	12200	4004 ⁵⁹	
OVAL TRACK Mechanical Roller Camshafts												
98818-16 ⁶	3100KT ⁴⁸ 7100	1604-16 ⁵⁹ 1804-16 ⁵⁹	7972-16 7913-16	26089-16 ² 26099-16 ²	731-16 733-16	611-16 614-16	503-16 ²	621-16	4000	12200	4004 ⁵⁹	
98818-16 ⁶	3100KT ⁴⁸ 7100	1604-16 ⁵⁹ 1804-16 ⁵⁹	7972-16 7913-16	26089-16 ² 26099-16 ²	731-16 733-16	611-16 614-16	503-16 ²	621-16	4000	12200	4004 ⁵⁹	
98818-16 ⁶	3100KT ⁴⁸ 7100	1604-16 ⁵⁹ 1804-16 ⁵⁹	7972-16 7913-16	26089-16 ² 26099-16 ²	731-16 733-16	611-16 614-16	503-16 ²	621-16	4000	12200	4004 ⁵⁹	
98818-16 ⁶	3100KT ⁴⁸ 7100	1604-16 ⁵⁹ 1804-16 ⁵⁹	7972-16 7913-16	26089-16 ² 26099-16 ²	731-16 733-16	611-16 614-16	503-16 ²	621-16	4000	12200	4004 ⁵⁹	

⁴⁸ Includes 3 cam bolts, thrust bearing, adjustable cam timing system, 2 machined steel gears & true roller chain

⁵⁹ Requires 7/16" rocker arm studs

RED NUMBERS DENOTE PREMIUM OPTION



CHEVROLET 262-400 C.I. 8 CYL. 1958-1998 (CONTINUED)

APPLICATIONS/CAMSHAFTS	VALVE SETTING		RPM OPERATING RANGE	CAM PART #	CAM GRIND #	DURATION				VALVE LIFT		LOBE SEP. ANGLE
	IN.	EX.				ADVERTISED IN.	EX.	@ .050" IN.	EX.	W/ 1.5 ROCKER IN.	EX.	
OVAL TRACK Mechanical Roller Camshafts – Xtreme TK Rollers (CONTINUED)												
Xtreme TK Rollers give more area under the curve and shorter seat timing than any other series. Great for Hi-Torque or restricted applications.												
MECHANICAL ROLLER – 3/8-1/2 mile tacky. 355-406 Late Model 4 BBL. Good top end.	.016	.020	3500 to 7500	12-858-9^{14, 46}	283TKBR-6	283	296	255	264	.645	.630	106°
MECHANICAL ROLLER – 3/8-5/8 mile dry slick. 355-406 Late Model. Great small cubic inch IMCA.	.016	.020	3500 to 7600	12-859-9^{14, 46}	285TKR-6	285	298	257	266	.645	.637	106°
MECHANICAL ROLLER – 377-406 Late Model w/ good heads, carb, intake and 1.6:1 rocker ratio.	.016	.020	3500 to 7800	12-860-9^{14, 46}	287TKR-6	287	296	259	264	.645	.630	106°

APPLICATIONS/CAMSHAFTS	VALVE SETTING		RPM OPERATING RANGE	CAM PART #	CAM GRIND #	DURATION				VALVE LIFT		LOBE SEP. ANGLE
	IN.	EX.				ADVERTISED IN.	EX.	@ .050" IN.	EX.	W/ 1.6 ROCKER IN.	EX.	
OPEN WHEEL MODIFIED TRACTION CONTROL Mechanical Roller Camshafts												
MECHANICAL ROLLER – 1/3-1/2 tracks w/ tight corners or heavy surface. 327-358, 11:1 compression, 2/4 BBL gas or alcohol. Designed for flat tappet-appearing Beehive™ Valve Springs.	.016	.018	3200 to 7500	12-780-9^{14, 46}	287CRL	287	291	256	260	.589	.589	107°
MECHANICAL ROLLER – 3/8-5/8 tracks w/ wide corners or slick surface. 355+, 12:1 compression, 4 BBL gas or alcohol with good intake & heads. Designed for flat tappet-appearing Beehive™ Valve Springs.	.016	.018	3400 to 7700	12-781-9^{14, 46}	291CRL	291	295	260	264	.589	.589	107°

APPLICATIONS/CAMSHAFTS	VALVE SETTING		RPM OPERATING RANGE	CAM PART #	CAM GRIND #	DURATION				VALVE LIFT		LOBE SEP. ANGLE
	IN.	EX.				ADVERTISED IN.	EX.	@ .050" IN.	EX.	W/ 1.5 ROCKER IN.	EX.	
OVAL TRACK Mechanical Roller Camshafts (.900" Base Circle)												
MECHANICAL ROLLER – For heavy cars with small c.i. Best for short tracks.	.020	.022	3200 to 6200	12-990-9^{14, 46}	288AR-6	288	296	252	258	.630	.630	106°
MECHANICAL ROLLER – Good for 1/4 to 3/8 mile tacky tracks with tight corners.	.020	.022	3500 to 6500	12-991-9^{14, 46}	292AR-6	292	296	256	258	.630	.630	106°
MECHANICAL ROLLER – Good torque and throttle response w/ 355c.i. engine on short track.	.020	.022	3600 to 6600	12-992-9^{14, 46}	296AR-6	296	300	260	262	.630	.630	106°
MECHANICAL ROLLER – More aggressive intake lobe, more torque. Good for sprint car.	.020	.022	3800 to 7000	12-920-9^{14, 46}	288BR-6	288	300	260	264	.660	.630	106°
MECHANICAL ROLLER – Good Late Model cam w/ 388-406c.i. on short track.	.020	.022	4200 to 7000	12-924-9^{14, 46}	296BR-4	296	304	260	267	.630	.630	104°
MECHANICAL ROLLER – Good cam for Sprint car on longer tracks.	.020	.022	4000 to 7000	12-921-9^{14, 46}	288CR-6	288	304	260	268	.660	.630	106°
MECHANICAL ROLLER – Best for Late Model with 406+ c.i. engine.	.020	.022	4200 to 7200	12-993-9^{14, 46}	300AR-6	300	304	264	267	.630	.630	106°
MECHANICAL ROLLER – Best torque in 406+c.i. Late Model or 355c.i. with 9:5.1+ compression.	.020	.022	4500 to 7500	12-922-9^{14, 46}	292BR-6	292	304	264	268	.660	.630	106°

² Requires machining on cylinder heads

⁶ Offset lifters available

¹⁴ Requires upgraded gear, thrust button & wear plate

⁴⁶ Must use bronze tip fuel pump pushrod when using high pressure or high volume pump

CHEVROLET 262-400 C.I. 8 CYL. 1958-1998 (CONTINUED)

CAMSHAFTS GENERAL MOTORS

LIFTERS	TIMING SET	ROCKER ARMS	PUSHRDS	VALVE SPRINGS	RETAINERS	VALVE LOCKS	VALVE SEALS	LASH CAPS	REV KIT	DIST. GEAR	STUD GIRDLES
OVAL TRACK Mechanical Roller Camshafts – Xtreme TK Rollers (CONTINUED)											
98818-16 ⁶	3100KT ⁴⁸ 7100	1604-16 ⁵⁹ 1804-16 ⁵⁹	7972-16 7913-16	26089-16 ² 26099-16 ²	731-16 733-16	611-16 614-16	503-16 ²	621-16	4000	12200	4004 ⁵⁹ 4009 ⁵⁹
98818-16 ⁶	3100KT ⁴⁸ 7100	1604-16 ⁵⁹ 1804-16 ⁵⁹	7972-16 7913-16	26089-16 ² 26099-16 ²	731-16 733-16	611-16 614-16	503-16 ²	621-16	4000	12200	4004 ⁵⁹ 4009 ⁵⁹
98818-16 ⁶	3100KT ⁴⁸ 7100	1604-16 ⁵⁹ 1804-16 ⁵⁹	7972-16 7913-16	26089-16 ² 26099-16 ²	731-16 733-16	611-16 614-16	503-16 ²	621-16	4000	12200 12140	4004 ⁵⁹ 4009 ⁵⁹

LIFTERS	TIMING SET	ROCKER ARMS	PUSHRDS	VALVE SPRINGS	RETAINERS	VALVE LOCKS	VALVE SEALS	LASH CAPS	REV KIT	DIST. GEAR	STUD GIRDLES
OPEN WHEEL MODIFIED TRACTION CONTROL Mechanical Roller Camshafts											
98818-16 ⁶	3100KT ⁴⁸ 7100	1605-16 ⁵⁹ 1805-16 ⁵⁹	7913-16	26095-16 ² 26055-16 ²	785-16	611-16 614-16	503-16 ²	621-16	4000	12200	4004 ⁵⁹ 4009 ⁵⁹
98818-16 ⁶	3100KT ⁴⁸ 7100	1605-16 ⁵⁹ 1805-16 ⁵⁹	7913-16	26095-16 ² 26055-16 ²	785-16	611-16 614-16	503-16 ²	621-16	4000	12200 12140	4004 ⁵⁹ 4009 ⁵⁹

LIFTERS	TIMING SET	ROCKER ARMS	PUSHRDS	VALVE SPRINGS	RETAINERS	VALVE LOCKS	VALVE SEALS	LASH CAPS	REV KIT	DIST. GEAR	STUD GIRDLES
OVAL TRACK Mechanical Roller Camshafts (.900" Base Circle)											
891-16 ⁶	3100KT ⁴⁸ 7100	1604-16 ⁵⁹ 1804-16 ⁵⁹	7972-16	943-16 ² 26089-16 ²	731-16 720-16	611-16 614-16	503-16 ²	621-16	4000	12200	4004 ⁵⁹
891-16 ⁶	3100KT ⁴⁸ 7100	1604-16 ⁵⁹ 1804-16 ⁵⁹	7972-16	943-16 ² 26089-16 ²	731-16 720-16	611-16 614-16	503-16 ²	621-16	4000	12200	4004 ⁵⁹
891-16 ⁶	3100KT ⁴⁸ 7100	1604-16 ⁵⁹ 1804-16 ⁵⁹	7972-16	943-16 ² 26089-16 ²	731-16 720-16	611-16 614-16	503-16 ²	621-16	4000	12200	4004 ⁵⁹
891-16 ⁶	3100KT ⁴⁸ 7100	1604-16 ⁵⁹ 1804-16 ⁵⁹	7972-16	943-16 ² 26089-16 ²	731-16 720-16	611-16 614-16	503-16 ²	621-16	4000	12200	4004 ⁵⁹
891-16 ⁶	3100KT ⁴⁸ 7100	1604-16 ⁵⁹ 1804-16 ⁵⁹	7972-16	943-16 ² 26089-16 ²	731-16 720-16	611-16 614-16	503-16 ²	621-16	4000	12200	4004 ⁵⁹
891-16 ⁶	3100KT ⁴⁸ 7100	1604-16 ⁵⁹ 1804-16 ⁵⁹	7972-16	943-16 ² 26089-16 ²	731-16 720-16	611-16 614-16	503-16 ²	621-16	4000	12200	4004 ⁵⁹
891-16 ⁶	3100KT ⁴⁸ 7100	1604-16 ⁵⁹ 1804-16 ⁵⁹	7972-16	943-16 ² 26089-16 ²	731-16 720-16	611-16 614-16	503-16 ²	621-16	4000	12200	4004 ⁵⁹
891-16 ⁶	3100KT ⁴⁸ 7100	1604-16 ⁵⁹ 1804-16 ⁵⁹	7972-16	943-16 ² 26089-16 ²	731-16 720-16	611-16 614-16	503-16 ²	621-16	4000	12200	4004 ⁵⁹

⁴⁸ Includes 3 cam bolts, thrust bearing, adjustable cam timing system, 2 machined steel gears & true roller chain

⁵⁹ Requires 7/16" rocker arm studs

RED NUMBERS DENOTE PREMIUM OPTION



CHEVROLET 262-400 C.I. 8 CYL. 1958-1998 (CONTINUED)

APPLICATIONS/CAMSHAFTS	VALVE SETTING		RPM OPERATING RANGE	CAM PART #	CAM GRIND #	DURATION				VALVE LIFT		LOBE SEP. ANGLE
	IN.	EX.				IN.	EX.	@ .050"	IN.	EX.	W/ 1.5 ROCKER	
OVAL TRACK Mechanical Roller Camshafts (.900" Base Circle)												
MECHANICAL ROLLER – High torque cam for use with a 1.6 or 1.65 intake rocker.	.020	.022	4200 to 7000	12-895-9^{14,46}	296CR-6	296	304	264	268	.609	.630	106°
MECHANICAL ROLLER – Good Late Model with large engine and slick track.	.020	.022	4500 to 7500	12-890-9^{14,46}	292CR-6	292	308	264	272	.660	.630	106°
MECHANICAL ROLLER – Good for Late Models with very large engine on long track.	.020	.022	4500 to 7500	12-994-9^{14,46}	304AR-6	304	308	268	270	.630	.630	106°
MECHANICAL ROLLER – Good for 430+c.i. engines in Late Models on slick tracks.	.020	.022	4200 to 7200	12-923-9^{14,46}	296BR-6	296	308	268	272	.660	.630	106°
MECHANICAL ROLLER – Good for constant high RPM, 358c.i. with open carb.	.020	.022	6200 to 8500	12-996-9^{14,46}	312AR-7	312	322	276	284	.630	.630	107°
OVAL TRACK Mechanical Roller Camshafts (.900" Base Circle)												
Xtreme TK Rollers give more area under the curve and shorter seat timing than any other series. Great for Hi-Torque or restricted applications.												
MECHANICAL ROLLER – 383-415c.i. IMCA, Late Model, Modifieds. Great torque.	.016	.020	3400 to 7600	12-861-9^{14,46}	287TKNR-7	287	300	259	268	.648	.645	107°
MECHANICAL ROLLER – 383-415c.i. Great for Late Model with 1.6:1 and good heads.	.016	.020	3600 to 7800	12-862-9^{14,46}	289TKNR-7	289	302	261	270	.648	.645	107°
MECHANICAL ROLLER – 415-430c.i. Great bottom end for short tacky track.	.016	.020	3400 to 7600	12-863-9^{14,46}	291TKNR-8	291	304	263	272	.648	.645	108°
MECHANICAL ROLLER – 415-430c.i. Late Model with good heads and open carb.	.016	.020	3600 to 7800	12-864-9^{14,46}	293TKNR-8	293	310	265	274	.648	.630	108°
OVAL TRACK Mechanical Roller Camshafts (50mm, 1.968" Roller Cam Bearings)												
Xtreme RX Rollers use COMP® RX intake and RZ exhaust profiles to provide the ultimate in high RPM power and durability. Designed for use with light valve train above 8200 RPM.												
MECHANICAL ROLLER – (50mm) 358c.i. Late Model with good heads and light valves.	.020	.022	5500 to 8500	12-850-9^{14,46}	294RX-6	294	301	261	268	.648	.648	106°
MECHANICAL ROLLER – (50mm) 400+c.i. Late Model with good heads and light valves.	.020	.022	5600 to 8600	12-851-9^{14,46}	298RX-6	298	305	265	272	.649	.651	106°
MECHANICAL ROLLER – (50mm) 430c.i. Late Model with good heads and light valves.	.020	.022	5400 to 8400	12-852-9^{14,46}	300RX-7	300	309	267	276	.651	.652	107°
MECHANICAL ROLLER – (50mm) 358c.i. High RPM asphalt track with very light valves.	.020	.022	7200 to 9200	12-853-9^{14,46}	304RX-8	304	313	271	280	.654	.657	108°
OVAL TRACK 4 & 7 FIRING ORDER SWAP Mechanical Roller Camshafts												
18736542 Firing Order												
MECHANICAL ROLLER – Best for heavy car and small engines on short tracks.	.020	.022	4000 to 7000	12-823-14^{14,46}	47S 288R-6	288	296	252	258	.630	.630	106°
MECHANICAL ROLLER – Dirt Late Model with good heads and 4 BBL carb.	.020	.022	4400 to 7600	12-826-14^{14,46}	47S 288BR-6	288	296	258	264	.639	.632	106°
MECHANICAL ROLLER – 355-400c.i. with 4 BBL carb. High RPM on long tracks.	.020	.022	6000 to 8200	12-824-14^{14,46}	47S 312R-7	312	322	276	284	.630	.630	107°

TECH TIP If you have a 1955-1957 Small Block Chevy engine, please notify your sales person before ordering.

² Requires machining on cylinder heads
⁶ Offset lifters available

¹⁴ Requires upgraded gear, thrust button & wear plate

⁴⁶ Must use bronze tip fuel pump pushrod when using high pressure or high volume pump

CHEVROLET 262-400 C.I. 8 CYL. 1958-1998 (CONTINUED)

CAMSHAFTS GENERAL MOTORS

LIFTERS	TIMING SET	ROCKER ARMS	PUSHRODS	VALVE SPRINGS	RETAINERS	VALVE LOCKS	VALVE SEALS	LASH CAPS	REV KIT	DIST. GEAR	STUD GIRDLES
OVAL TRACK Mechanical Roller Camshafts (.900" Base Circle)											
891-16 ⁶	3100KT ⁴⁸ 7100	1604-16 ⁵⁹ 1804-16 ⁵⁹	7972-16	943-16 ² 26089-16 ²	731-16 720-16	611-16 614-16	503-16 ²	621-16	4000	12200	4004 ⁵⁹ 4009 ⁵⁹
891-16 ⁶	3100KT ⁴⁸ 7100	1604-16 ⁵⁹ 1804-16 ⁵⁹	7972-16	943-16 ² 26089-16 ²	731-16 720-16	611-16 614-16	503-16 ²	621-16	4000	12200	4004 ⁵⁹ 4009 ⁵⁹
891-16 ⁶	3100KT ⁴⁸ 7100	1604-16 ⁵⁹ 1804-16 ⁵⁹	7972-16	943-16 ² 26089-16 ²	731-16 720-16	611-16 614-16	503-16 ²	621-16	4000	12200	4004 ⁵⁹ 4009 ⁵⁹
891-16 ⁶	3100KT ⁴⁸ 7100	1604-16 ⁵⁹ 1804-16 ⁵⁹	7972-16	943-16 ² 26089-16 ²	731-16 720-16	611-16 614-16	503-16 ²	621-16	4000	12200	4004 ⁵⁹ 4009 ⁵⁹
891-16 ⁶	3100KT ⁴⁸ 7100	1604-16 ⁵⁹ 1804-16 ⁵⁹	7972-16	943-16 ² 26089-16 ²	731-16 720-16	611-16 614-16	503-16 ²	621-16	4000	12200	4004 ⁵⁹ 4009 ⁵⁹
OVAL TRACK Mechanical Roller Camshafts (.900" Base Circle)											
891-16 ⁶	3100KT48 7100	1604-16 ⁵⁹ 1804-16 ⁵⁹	7972-16	26089-16 ² 26099-16 ²	731-16 733-16	611-16 614-16	503-16 ²	621-16	4000	12200	4004 ⁵⁹ 4009 ⁵⁹
891-16 ⁶	3100KT48 7100	1604-16 ⁵⁹ 1804-16 ⁵⁹	7972-16	26089-16 ² 26099-16 ²	731-16 733-16	611-16 614-16	503-16 ²	621-16	4000	12200	4004 ⁵⁹ 4009 ⁵⁹
891-16 ⁶	3100KT48 7100	1604-16 ⁵⁹ 1804-16 ⁵⁹	7972-16	26089-16 ² 26099-16 ²	731-16 733-16	611-16 614-16	503-16 ²	621-16	4000	12200	4004 ⁵⁹ 4009 ⁵⁹
891-16 ⁶	3100KT48 7100	1604-16 ⁵⁹ 1804-16 ⁵⁹	7972-16	26089-16 ² 26099-16 ²	731-16 733-16	611-16 614-16	503-16 ²	621-16	4000	12200	4004 ⁵⁹ 4009 ⁵⁹
OVAL TRACK Mechanical Roller Camshafts (50mm, 1.968" Roller Cam Bearings)											
818-16 ⁶	3100KT ⁴⁸ 7100	1604-16 ⁵⁹ 1804-16 ⁵⁹	7972-16 7913-16	26089-16 ² 26099-16 ²	731-16 733-16	611-16 614-16	503-16 ²	621-16	4000	12200	4004 ⁵⁹ 4009 ⁵⁹
818-16 ⁶	3100KT ⁴⁸ 7100	1604-16 ⁵⁹ 1804-16 ⁵⁹	7972-16 7913-16	26089-16 ² 26099-16 ²	731-16 733-16	611-16 614-16	503-16 ²	621-16	4000	12200	4004 ⁵⁹ 4009 ⁵⁹
818-16 ⁶	3100KT ⁴⁸ 7100	1604-16 ⁵⁹ 1804-16 ⁵⁹	7972-16 7913-16	26089-16 ² 26099-16 ²	731-16 733-16	611-16 614-16	503-16 ²	621-16	4000	12200	4004 ⁵⁹ 4009 ⁵⁹
818-16 ⁶	3100KT ⁴⁸ 7100	1604-16 ⁵⁹ 1804-16 ⁵⁹	7972-16 7913-16	26089-16 ² 26099-16 ²	731-16 733-16	611-16 614-16	503-16 ²	621-16	4000	12200	4004 ⁵⁹ 4009 ⁵⁹
OVAL TRACK 4 & 7 FIRING ORDER SWAP Mechanical Roller Camshafts											
818-16 ⁶	3100KT ⁴⁸ 6500	1604-16 ⁵⁹ 1804-16 ⁵⁹	7972-16 7913-16	954-16 ² 944-16 ²	732-16 731-16	611-16 614-16	503-16 ²	621-16	4000	12200	4004 ⁵⁹ 4009 ⁵⁹
818-16 ⁶	3100KT ⁴⁸ 6500	1604-16 ⁵⁹ 1804-16 ⁵⁹	7972-16 7913-16	954-16 ² 944-16 ²	732-16 731-16	611-16 614-16	503-16 ²	621-16	4000	12200	4004 ⁵⁹ 4009 ⁵⁹
818-16 ⁶	3100KT ⁴⁸ 6500	1604-16 ⁵⁹ 1804-16 ⁵⁹	7972-16 7913-16	954-16 ² 944-16 ²	732-16 731-16	611-16 614-16	503-16 ²	621-16	4000	12200 12140	4004 ⁵⁹ 4009 ⁵⁹

⁴⁸ Includes 3 cam bolts, thrust bearing, adjustable cam timing system, 2 machined steel gears & true roller chain

⁵⁹ Requires 7/16" rocker arm studs

RED NUMBERS DENOTE PREMIUM OPTION

CHEVROLET 262-400 C.I. 8 CYL. 1958-1998 (CONTINUED)

APPLICATIONS/CAMSHAFTS	VALVE SETTING		RPM OPERATING RANGE	CAM PART #	CAM GRIND #	DURATION				VALVE LIFT		LOBE SEP. ANGLE
	IN.	EX.				ADVERTISED IN.	EX.	@ .050" IN.	EX.	W/ 1.6 ROCKER IN.	EX.	
OPEN WHEEL MODIFIED TRACTION CONTROL 4 & 7 FIRING ORDER SWAP Mechanical Roller Camshafts												
MECHANICAL ROLLER – 1/3-1/2 tracks w/ tight corners or heavy surface. 327-358ci., 11:1 compression, 4 BBL gas or alcohol. Requires good intake and heads.	.016	.018	3600 to 7400	12-840-14¹⁴	285HXL	285	294	256	261	.702	.691	107°
MECHANICAL ROLLER – 1/3-1/2 tracks w/ wide corners or slick surface. 355-383ci., 12:1 compression, 4 BBL gas or alcohol. Requires good intake and heads.	.016	.018	3800 to 7600	12-841-14¹⁴	289HXL	289	298	260	265	.709	.694	107°
MECHANICAL ROLLER – 3/8-5/8 tracks w/ tight corners or heavy surface. 355-383ci., 12:1+ compression, 4 BBL gas or alcohol. Requires good intake & heads.	.016	.018	4000 to 7800	12-842-14¹⁴	293HXL	293	302	264	269	.715	.698	107°
MECHANICAL ROLLER – 3/8-5/8 tracks w/ wide corners or slick surface. 383+c.i., 12:1+ compression, 4 BBL gas or alcohol. Requires good intake and heads.	.016	.018	4200 to 8000	12-843-14¹⁴	297HXL	297	306	268	273	.722	.701	107°

GM LT1 & LT4 350 C.I. 8 CYL. 1995-1997

APPLICATIONS/CAMSHAFTS	VALVE SETTING		RPM OPERATING RANGE	CAM PART #	CAM GRIND #	DURATION				VALVE LIFT		LOBE SEP. ANGLE
	IN.	EX.				ADVERTISED IN.	EX.	@ .050" IN.	EX.	W/ 1.5 ROCKER IN.	EX.	
XTREME ENERGY™ Hydraulic Roller Camshafts												
HYDRAULIC ROLLER – Good in factory LT1, noticeable increase over stock cam.	Hyd.	Hyd.	1000 to 5000	07-304-8⁴⁶	266HR-14	266	276	210	220	.500	.510	114°
HYDRAULIC ROLLER – For use in LT1, with custom tuning.	Hyd.	Hyd.	1500 to 5500	07-305-8⁴⁶	276HR-14	276	290	220	230	.510	.510	114°
HYDRAULIC ROLLER – For use in LT1, with custom tuning, headers, gears, and 2200+ stall. Rough Idle.	Hyd.	Hyd.	1800 to 5800	07-306-8⁴⁶	290HR-12	290	307	230	244	.510	.540	112°
HYDRAULIC ROLLER – Good in factory LT1, increased power and economy over stock.	Hyd.	Hyd.	1000 to 5000	07-500-8⁴⁶	258HR-12	258	264	206	212	.480	.488	112°
HYDRAULIC ROLLER – Best for increased power in LT1 engines w/ minimal mods. Requires custom tuning.	Hyd.	Hyd.	1200 to 5200	07-501-8⁴⁶	264HR-12	264	269	212	218	.488	.495	112°
HYDRAULIC ROLLER – Good for performance LT1. Requires custom tuning and upgraded exhaust.	Hyd.	Hyd.	1500 to 5500	07-502-8⁴⁶	269HR-12	269	276	218	224	.495	.503	112°
HYDRAULIC ROLLER – Best cam for modified LT1, better exhaust & 2000+ converter. Requires custom tuning.	Hyd.	Hyd.	1800 to 5800	07-503-8⁴⁶	276HR-12	276	281	224	230	.503	.510	112°

APPLICATIONS/CAMSHAFTS	VALVE SETTING		RPM OPERATING RANGE	CAM PART #	CAM GRIND #	DURATION				VALVE LIFT		LOBE SEP. ANGLE
	IN.	EX.				ADVERTISED IN.	EX.	@ .050" IN.	EX.	W/ 1.6 ROCKER IN.	EX.	
XTREME FUEL INJECTION (XFI™) Hydraulic Roller Camshafts (WITH 1.6 ROCKERS)												
HYDRAULIC ROLLER – Excellent torque and economy with noticeable horsepower gains.	Hyd.	Hyd.	1000 to 5000	07-464-8⁴⁶	252XFI HR13	252	264	202	212	.550	.546	113°
HYDRAULIC ROLLER – Superb low end and mid-range with minimal modifications.	Hyd.	Hyd.	1200 to 5200	07-465-8⁴⁶	260XFI HR13	260	270	210	218	.560	.555	113°
HYDRAULIC ROLLER – Good low end torque with exceptional mid-range. Needs upgraded exhaust and programmer or chip.	Hyd.	Hyd.	1800 to 5800	07-466-8⁴⁶	268XFI HR13	268	276	218	224	.570	.565	113°
HYDRAULIC ROLLER – Strong mid-range and top end. Requires headers, gears, 2200+ stall, and modified computer. Strong Idle.	Hyd.	Hyd.	2000 to 6000	07-467-8⁴⁶	280XFI HR13	280	288	230	236	.576	.570	113°
HYDRAULIC ROLLER – Good mid-range with excellent top end. Will require headers, gears, 2500+ stall and custom programmer. Rough Idle.	Hyd.	Hyd.	2200 to 6200	07-468-8⁴⁶	292XFI HR13	292	300	242	248	.584	.579	113°

² Requires machining on cylinder heads⁶ Offset lifters available⁷ Stock springs cannot be used¹¹ Lifters only, does not include lifter retainers or guides¹⁴ Requires upgraded gear, thrust button & wear plate⁴⁶ Must use bronze tip fuel pump pushrod when using high pressure or high volume pump

CHEVROLET 262-400 C.I. 8 CYL. 1958-1998 (CONTINUED)

CAMSHAFTS
GENERAL MOTORS

LIFTERS	TIMING SET	ROCKER ARMS	PUSHRODS	VALVE SPRINGS	RETAINERS	VALVE LOCKS	VALVE SEALS	LASH CAPS	REV KIT	DIST. GEAR	STUD GIRDLES	
OPEN WHEEL MODIFIED TRACTION CONTROL 4 & 7 FIRING ORDER SWAP Mechanical Roller Camshafts												
818-16 ⁶	3100KT ⁴⁸ 6500	1605-16 ⁵⁹ 1805-16 ⁵⁹	7913-16	26075-16 ² 26091-16 ²	738-16 784-16	611-16 614-16	503-16 ²	621-16	4000	12200	4004 ⁵⁹	
818-16 ⁶	3100KT ⁴⁸ 6500	1605-16 ⁵⁹ 1805-16 ⁵⁹	7913-16	26075-16 ² 26091-16 ²	738-16 784-16	611-16 614-16	503-16 ²	621-16	4000	12200	4004 ⁵⁹	
818-16 ⁶	3100KT ⁴⁸ 6500	1605-16 ⁵⁹ 1805-16 ⁵⁹	7913-16	26075-16 ² 26091-16 ²	738-16 784-16	611-16 614-16	503-16 ²	621-16	4000	12200	4004 ⁵⁹	
818-166	3100KT ⁴⁸ 6500	1605-16 ⁵⁹ 1805-16 ⁵⁹	7913-16	26075-16 ² 26091-16 ²	738-16 784-16	611-16 614-16	503-16 ²	621-16	4000	12200 12140	4004 ⁵⁹ 4009 ⁵⁹	

GM LT1 & LT4 350 C.I. 8 CYL. 1995-1997

LIFTERS	TIMING SET	ROCKER ARMS	PUSHRODS	VALVE SPRINGS	RETAINERS	VALVE LOCKS	VALVE SEALS	LASH CAPS	REV KIT	DIST. GEAR	STUD GIRDLES	
XTREME ENERGY™ Hydraulic Roller Camshafts												
850-16 ¹¹ 875-16 ¹¹	3207 ⁷⁹	1417-16 1617-16	7608-16 7940-16	26915-16 26918-16	787-16 1787-16	648-16	501-16 503-16 ²	N/A	N/A	412M	N/A	
850-16 ¹¹ 875-16 ¹¹	3207 ⁷⁹	1417-16 1617-16	7608-16 7940-16	26915-16 26918-16	787-16 1787-16	648-16	501-16 503-16 ²	N/A	N/A	412M	N/A	
850-16 ¹¹ 875-16 ¹¹	3207 ⁷⁹	1417-16 1617-16	7608-16 7940-16	26918-16	787-16 1787-16	648-16	501-16 503-16 ²	N/A	N/A	412M	N/A	
850-16 ¹¹ 875-16 ¹¹	3207 ⁷⁹	1417-16 1617-16	7608-16 7940-16	26915-16 26918-16	787-16 1787-16	648-16	501-16 503-16 ²	N/A	N/A	412M	N/A	
850-16 ¹¹ 875-16 ¹¹	3207 ⁷⁹	1417-16 1617-16	7608-16 7940-16	26915-16 26918-16	787-16 1787-16	648-16	501-16 503-16 ²	N/A	N/A	412M	N/A	
850-16 ¹¹ 875-16 ¹¹	3207 ⁷⁹	1417-16 1617-16	7608-16 7940-16	26915-16 26918-16	787-16 1787-16	648-16	501-16 503-16 ²	N/A	N/A	412M	N/A	
850-16 ¹¹ 875-16 ¹¹	3207 ⁷⁹	1417-16 1617-16	7608-16 7940-16	26918-16	787-16 1787-16	648-16	501-16 503-16 ²	N/A	N/A	412M	N/A	

K-KIT	CL-KIT	RP-KIT	LIFTERS	DIST. GEAR	TIMING SET	ROCKER ARMS	PUSHRODS	VALVE SPRINGS	RETAINERS	VALVE LOCKS	VALVE SEALS	
XTREME FUEL INJECTION (XFI™) Hydraulic Roller Camshafts (WITH 1.6 ROCKERS)												
K07-464-8 ⁷⁸	CL07-464-8 ⁷	RPM1418-16 RPM1618-16	850-16 ¹¹ 875-16 ¹¹	412M	3207 ⁷⁹	1418-16 1618-16	7608-16 7940-16	26918-16	787-16 1787-16	601-16 648-16	502-16 503-16 ²	
K07-465-8 ⁷⁸	CL07-465-8 ⁷	RPM1418-16 RPM1618-16	850-16 ¹¹ 875-16 ¹¹	412M	3207 ⁷⁹	1418-16 1618-16	7608-16 7940-16	26918-16	787-16 1787-16	601-16 648-16	502-16 503-16 ²	
K07-466-8 ⁷⁸	CL07-466-8 ⁷	RPM1418-16 RPM1618-16	850-16 ¹¹ 875-16 ¹¹	412M	3207 ⁷⁹	1418-16 1618-16	7608-16 7940-16	26918-16	787-16 1787-16	601-16 648-16	502-16 503-16 ²	
K07-467-8 ⁷⁸	CL07-467-8 ⁷	RPM1418-16 RPM1618-16	850-16 ¹¹ 875-16 ¹¹	412M	3207 ⁷⁹	1418-16 1618-16	7608-16 7940-16	26918-16	787-16 1787-16	601-16 648-16	502-16 503-16 ²	
K07-468-8 ⁷⁸	CL07-468-8 ⁷	RPM1418-16 RPM1618-16	850-16 ¹¹ 875-16 ¹¹	412M	3207 ⁷⁹	1418-16 1618-16	7608-16 7940-16	26918-16 26925-16	787-16 1779-16	601-16 648-16	502-16 503-16 ²	

⁴⁸ Includes 3 cam bolts, thrust bearing, adjustable cam timing system, 2 machined steel gears & true roller chain

⁵⁹ Requires 7/16" rocker arm studs
⁷⁸ K-Kits do not include timing sets
⁷⁹ For 1995 and later engines only

RED NUMBERS DENOTE PREMIUM OPTION



LS ENGINE CAR APPLICATIONS

RPO	YEAR	APPLICATIONS	CORE	VARIABLE VALVE TIMING	ACTIVE FUEL MANAGEMENT/ DISPLACEMENT ON DEMAND	LITER
LS1	1997-2004	1997-2004 Corvette	Three-Bolt 54 Prefix	NO	NO	5.7
		1998-2002 Camaro/Trans Am				
		2004 Pontiac GTO				
LS6	2001-2005	2001-2004 Corvette Z06	Three-Bolt 54 Prefix	NO	NO	5.7
		2004-2005 Cadillac CTS V				
LS2	2005-2009	2005-2007 Buick Rainier	Three-Bolt 54 Prefix	NO	NO	6.0
		2005-2006 Pontiac GTO				
		2006-2007 Cadillac CTS V				
		2005-2007 Corvette				
		2005-2006 SSR				
		2006-2009 Trailblazer SS				
LS7	2006-Present	2006-Present Corvette Z06	Three-Bolt 54 Prefix	NO	NO	7.0
LS9	2009	2009 Corvette ZR1	Three-Bolt 54 Prefix	NO	NO	6.2
LS3	2008-Present	2008-Present Corvette	Single-Bolt 146 Prefix	NO	NO	6.2
		2009 Pontiac G8 GXP				
		2010-Present Camaro SS (Manual)				
LS4	2006-2009	2006-2009 Impala SS	Single-Bolt 646 Prefix	NO	YES	5.3
		2006-2007 Monte Carlo SS				
		2005-2008 Pontiac Grand Prix GXP				
		2008 Buick LaCrosse				
L98	2007-2008	2007-2008 Lumina SS	Single-Bolt 146 Prefix	NO	NO	6.0
		2007-2008 Caprice SS				
L76	2008-2009	2008-2009 Pontiac G8 GT	Single-Bolt 646 Prefix	NO	YES	6.0
L77	2011-Present	2011-Present Caprice Police Vehicle	Single-Bolt 646 Prefix	NO	YES	6.0
L99	2010-Present	2010-Present Camaro SS (Auto)	Single-Bolt 689 Prefix	YES	YES	6.2
LSA	2009-Present	2009-Present Cadillac CTS V	Single-Bolt 146 Prefix	NO	NO	6.2
		2012 Camaro ZL1				

GM LS ACCESSORIES



TIMING SETS
See page 318 for details



FRONT COVERS
See page 321 for details



DEGREE KIT
See page 328 for details

OUR EXPERIENCED TEAM OF
TECHNICIANS CAN HELP ANSWER
YOUR VALVE TRAIN QUESTIONS

CAMHELP® 800.999.0853

LS ENGINE TRUCK APPLICATIONS

RPO	YEAR	APPLICATIONS	CORE	VARIABLE VALVE TIMING	ACTIVE FUEL MANAGEMENT/ DISPLACEMENT ON DEMAND	LITER
LR4	1999-2007	1999-2006 Tahoe/Yukon	Three-Bolt 54 Prefix	NO	NO	4.8
		1999-2007 Silverado/Sierra				
		2003-2007 Express 2500-3500				
		2003-2007 Savana 2500-3500				
LY2	2007-2009	2007-2009 Silverado/Sierra	Single-Bolt 146 Prefix	NO	NO	4.8
		2007-2009 Tahoe/Yukon				
		2008-2009 Express 2500-3500 2008-2009 Savana 2500-3500				
L20	2009-Present	2009-Present Silverado/Sierra	Single-Bolt 189 Prefix	YES	NO	4.8
		2009-Present Express/Savana				
LM7	1999-2007	1999-2006 Tahoe/Yukon	Three-Bolt 54 Prefix	NO	NO	5.3
		1999-2006 Suburban/Yukon XL				
		1999-2007 Silverado/Sierra				
		2002-2005 Escalade 2WD				
		2002-2006 Avalanche 2003-2007 Express/Savana				
LM4	2003-2004	2003-2004 Trailblazer EXT	Three-Bolt 54 Prefix	NO	NO	5.3
		2004 Envoy XL				
		2003-2004 SSR 2004 Buick Rainier				
L33	2005-2007	2005-2007 Silverado/Sierra 4WD	Three-Bolt 54 Prefix	NO	NO	5.3
L59	2002-2007	2002-2007 Silverado/Sierra	Three-Bolt 54 Prefix	NO	NO	5.3
		2002-2006 Tahoe/Yukon				
		2002-2006 Suburban/Yukon XL				
LH6	2005-2009	2005 Envoy XUV	Single-Bolt 646 Prefix	NO	YES	5.3
		2005-2006 Envoy XL				
		2005-2009 Envoy Denali				
		2005-2009 Trailblazer				
		2007 Silverado 1500				
		2005-2007 Buick Rainier 2007-2009 Sierra 1500				
LY6	2007-Present	2007-Present Avalanche	Single-Bolt 646 Prefix	NO	YES	5.3
		2007-Present Silverado/Sierra				
		2007-Present Tahoe/Yukon 2007-Present Suburban/Yukon XL				
LMG	2007-Present	2007-Present Avalanche	Single-Bolt 646 Prefix	NO	YES	5.3
		2007-Present Tahoe/Yukon				
		2007-Present Suburban/Yukon XL				
LC9	2007-Present	2007-Present Avalanche	Single Bolt 689 Prefix	YES	YES	5.3
		2007-Present Suburban/Yukon XL				
LH8	2008-2010	2008-2010 Hummer H3	Single-Bolt 146 Prefix	NO	NO	5.3
		2009-2010 Colorado/Canyon				
LH9	2010-Present	2010-Present Colorado/Canyon	Single-Bolt 189 Prefix	YES	NO	5.3
LMF	2010-Present	2010-Present Express/Savana	Single-Bolt 189 Prefix	YES	NO	5.3
LQ4	1999-2007	1999-2007 Express/Savana	Three-Bolt 54 Prefix	NO	NO	6.0
		1999-2001 Silverado/Sierra 2500/23500				
		1999-2001 Suburban/Yukon XL 2500				
		2003-2007 Hummer H2				

CAMSHAFTS GENERAL MOTORS

LS ENGINE TRUCK APPLICATIONS (CONTINUED)

RPO	YEAR	APPLICATIONS	CORE	VARIABLE VALVE TIMING	ACTIVE FUEL MANAGEMENT/ DISPLACEMENT ON DEMAND	LITER
LQ9	2002-2007	2002-2006 Cadillac Escalade	Three-Bolt 54 Prefix	NO	NO	6.0
		2002-2006 Cadillac Escalade EXT				
		2003-2006 Cadillac Escalade ESV				
		2003-2007 Silverado SS				
		2004-2005 Silverado/Sierra HO Edition				
LY6	2007-2010	2006-2007 Silverado/Sierra MAX Option	Single-Bolt 156 Prefix	YES	NO	6.0
		2007 Silverado/Sierra HD				
		2007 Suburban, Yukon XL 2500				
LY6	2008-2010	2007 Express/Savana	Single-Bolt 189 Prefix	YES	NO	6.0
		2007-2010 Silverado/Sierra HD				
L76	2007-2009	2007-2010 Suburban, Yukon XL 2500	Single-Bolt 656 Prefix	YES	YES	6.0
		2007-2010 Express/Savana				
L76	2007-2009	2007-2009 Silverado/Sierra	Single-Bolt 689 Prefix	YES	YES	6.0
		2007-2009 Suburban/Yukon XL				
LFA	2008-2009	2007-2009 Avalanche	Single-Bolt 646 Prefix	NO	YES	6.0
		2007-2009 Silverado/Sierra				
		2007-2009 Suburban/Yukon XL				
LZ1	2010-Present	2007-2009 Avalanche	Single-Bolt 646 Prefix	NO	YES	6.0
		2008-2009 Tahoe/Yukon Hybrid				
		2009 Cadillac Escalade Hybrid				
L96	2011-Present	2009 Silverado/Sierra Hybrid	Single-Bolt 189 Prefix	YES	NO	6.0
		2010 Present Silverado/Sierra HD				
LC8	2011-Present	2010 Present Suburban, Yukon XL 2500	Single-Bolt 189 Prefix	YES	NO	6.0
		2010 Present Express/Savana				
		2011 Present Silverado/Sierra HD-CNG				
L92	2007-Present	2011-Present Suburban, Yukon XL 2500-CNG	Single-Bolt 656 Prefix	YES	YES	6.2
		2007-2008 Cadillac Escalade				
		2007-2008 Yukon/Yukon XL Denali				
		2008-2009 Hummer H2				
		2009 Tahoe LTZ				
L9H	2009-Present	2009-Present Silverado/Sierra 1500	Single-Bolt 689 Prefix	YES	YES	6.2
		2007-2008 Sierra Denali				
		2009-Present Cadillac Escalade				
		2009-Present Tahoe LTZ/Yukon Denali				
L94	2010-Present	2009-Present Sierra Denali/SLT	Single-Bolt 689 Prefix	YES	YES	6.2
		2009-Present Silverado LTZ				
		2009 Hummer H2				
L94	2010-Present	2010 Present Cadillac Escalade	Single-Bolt 689 Prefix	YES	YES	6.2
		2010-Present Yukon Denali				



HOW TO IDENTIFY YOUR GM LS NON-VVT ENGINE MANAGEMENT SYSTEM

Three-Bolt Cam
No or 1 Pole Reluctor
"54" Series

Three-Bolt Cam
4 Pole Reluctor
"54" Series

Single-Bolt Cam
4 Pole Reluctor
"146" and "646" Series

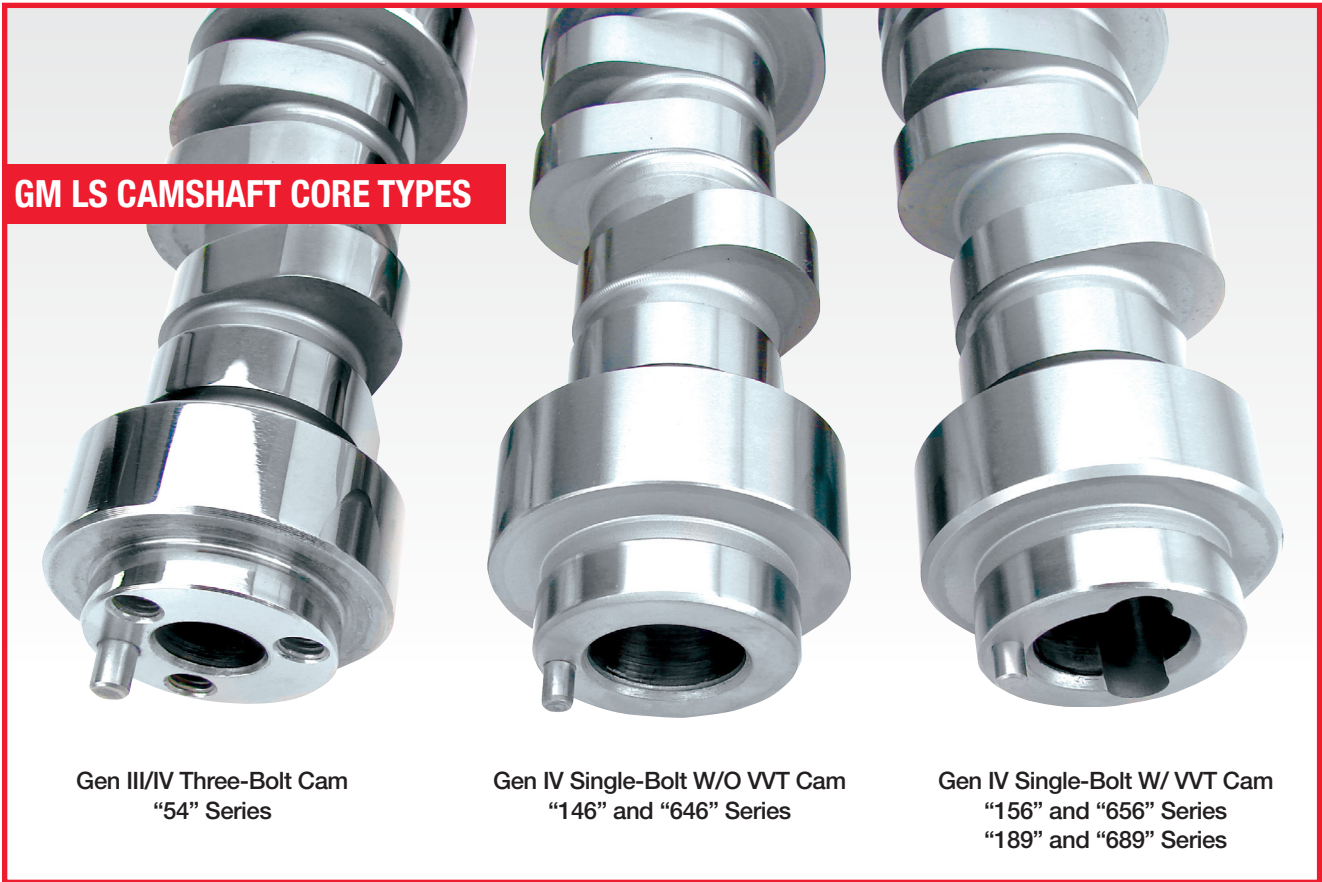

GM LS CAMSHAFT CORE TYPES

Gen III/IV Three-Bolt Cam
"54" Series

Gen IV Single-Bolt W/O VVT Cam
"146" and "646" Series

Gen IV Single-Bolt W/ VVT Cam
"156" and "656" Series
"189" and "689" Series

GM LS GEN III/IV THREE-BOLT 8 CYL. 1997-PRESENT

APPLICATIONS/CAMSHAFTS	VALVE SETTING		RPM OPERATING RANGE	CAM PART #	CAM GRIND #	DURATION				VALVE LIFT		LOBE SEP. ANGLE
	IN.	EX.				IN.	EX.	IN.	EX.	IN.	EX.	
XFI™ RPM Hydraulic Roller Camshafts												
HYDRAULIC ROLLER – Very strong torque, good mileage. Noticeable increase over stock cam.	Hyd.	Hyd.	800 to 5800	54-408-11⁷	XR259HR	259	265	206	212	.515	.522	112°
HYDRAULIC ROLLER – Good torque and very strong mid-range power. Good performance cam.	Hyd.	Hyd.	1200 to 6000	54-412-11⁷	XR265HR	265	271	212	218	.522	.529	114°
HYDRAULIC ROLLER – Great mid-range with superior top end power. Needs programmer.	Hyd.	Hyd.	1300 to 6300	54-414-11⁷	XR269HR	269	273	216	220	.525	.532	114°
HYDRAULIC ROLLER – Street/strip camshaft for high RPM power. Likes higher rocker ratios. Must have programmer.	Hyd.	Hyd.	1600 to 6600	54-416-11⁷	XR273HR	273	277	220	224	.530	.534	112°
HYDRAULIC ROLLER – Street/strip camshaft designed for use with FAST™ LSX™ intake. Requires programmer.	Hyd.	Hyd.	2000 to 6800	54-418-11⁷	XR277HR	277	281	224	228	.534	.537	112°
XFI™ RPM HI-LIFT Hydraulic Roller Camshafts												
HYDRAULIC ROLLER – Great street cam with very wide power range, good drivability and excellent response.	Hyd.	Hyd.	1400 to 6700	54-424-11⁷	XR265HR	265	271	212	218	.558	.563	115°
HYDRAULIC ROLLER – Great street/strip camshaft for mid-range and high RPM power. Must have programmer.	Hyd.	Hyd.	1800 to 6800	54-426-11⁷	XR275HR	275	277	222	224	.566	.568	112°
HYDRAULIC ROLLER – High RPM street/strip camshaft for use with FAST™ LSX™ intake. Requires programmer.	Hyd.	Hyd.	2200 to 7200	54-428-11⁷	XR281HR	281	283	228	230	.571	.573	112°
XFI™ XE-R Hydraulic Roller Camshafts												
HYDRAULIC ROLLER – High RPM street/strip with XE-R lobe designs. Requires custom tuning.	Hyd.	Hyd.	2000 to 7000	54-444-11⁷	XER273HR	273	279	224	230	.581	.588	114°
HYDRAULIC ROLLER – Xtreme Energy XE-R design for standard displacement LS6 and LS1.	Hyd.	Hyd.	2400 to 7200	54-446-11⁷	XER281HR	281	283	232	234	.595	.598	112°
HYDRAULIC ROLLER – Xtreme Energy XE-R design for large cubic inch LS6 and LS1.	Hyd.	Hyd.	2800 to 7200	54-448-11⁷	XER287HR	287	289	238	240	.605	.609	112°
XFI™ XTREME TRUCK Hydraulic Roller Camshafts												
HYDRAULIC ROLLER – 4.8L/5.3L Chevrolet/GMC truck. Significant gains in mid and upper RPM range. Works best with programmer.	Hyd.	Hyd.	800 to 5000	54-450-11⁷	G3 XFI 260 HR15	260	266	206	212	.513	.520	115°
HYDRAULIC ROLLER – 6.0L Chevrolet/GMC truck. Significant gains in mid and upper RPM range. Works best with programmer.	Hyd.	Hyd.	800 to 5200	54-452-11⁷	G3 XFI 266 HR15	266	270	212	216	.520	.524	115°
HYDRAULIC ROLLER – 5.3L/6.0L Chevrolet/GMC truck. Significant gains in mid and upper RPM range. Exhaust upgrade needed for best performance. Needs programmer.	Hyd.	Hyd.	1000 to 5700	54-451-11⁷	G3 XFI 261 HR15	261	265	208	212	.554	.558	115°

TECH TIP

It is NOT recommended to use synthetic oil for LS engine break-in.

⁷ Stock springs cannot be used

¹¹ Lifters only, does not include lifter retainers or guides

GM LS GEN III/IV THREE-BOLT 8 CYL. 1997-PRESENT

CAMSHAFTS GENERAL MOTORS

LIFTERS	TIMING SET	ROCKER ARMS & KITS	ROCKER TRUNNION UPGRADE KIT	PUSHRODS	BEEHIVE™ VALVE SPRING KITS RETAINER MATERIAL			DUAL VALVE SPRING KITS RETAINER MATERIAL	
					STEEL	TOOL STEEL	TITANIUM	TOOL STEEL	TITANIUM
XFI™ RPM Hydraulic Roller Camshafts									
850-16 ¹¹ 875-16 ¹¹	3158KT	19026-16 1500	13702-KIT	7955-16	26915CS-KIT 26918CS-KIT	26915TS-KIT 26918TS-KIT	26915TI-KIT 26918TI-KIT	26925TS-KIT	26925TI-KIT
850-16 ¹¹ 875-16 ¹¹	3158KT	19026-16 1500	13702-KIT	7955-16	26915CS-KIT 26918CS-KIT	26915TS-KIT 26918TS-KIT	26915TI-KIT 26918TI-KIT	26925TS-KIT	26925TI-KIT
850-16 ¹¹ 875-16 ¹¹	3158KT	19026-16 1500	13702-KIT	7955-16	26915CS-KIT 26918CS-KIT	26915TS-KIT 26918TS-KIT	26915TI-KIT 26918TI-KIT	26925TS-KIT	26925TI-KIT
850-16 ¹¹ 875-16 ¹¹	3158KT	19026-16 1500	13702-KIT	7955-16	26915CS-KIT 26918CS-KIT	26915TS-KIT 26918TS-KIT	26915TI-KIT 26918TI-KIT	26925TS-KIT	26925TI-KIT
850-16 ¹¹ 875-16 ¹¹	3158KT	19026-16 1500	13702-KIT	7955-16	26915CS-KIT 26918CS-KIT	26915TS-KIT 26918TS-KIT	26915TI-KIT 26918TI-KIT	26925TS-KIT	26925TI-KIT
XFI™ RPM HI-LIFT Hydraulic Roller Camshafts									
850-16 ¹¹ 875-16 ¹¹	3158KT	19026-16 1500	13702-KIT	7955-16	26918CS-KIT	26918TS-KIT	26918TI-KIT	26925TS-KIT	26925TI-KIT
850-16 ¹¹ 875-16 ¹¹	3158KT	19026-16 1500	13702-KIT	7955-16	26918CS-KIT	26918TS-KIT	26918TI-KIT	26925TS-KIT	26925TI-KIT
850-16 ¹¹ 875-16 ¹¹	3158KT	19026-16 1500	13702-KIT	7955-16	26918CS-KIT	26918TS-KIT	26918TI-KIT	26925TS-KIT	26925TI-KIT
XFI™ XE-R Hydraulic Roller Camshafts									
850-16 ¹¹ 875-16 ¹¹	3158KT	19026-16 1500	13702-KIT	7955-16	N/A	N/A	N/A	26925TS-KIT	26925TI-KIT
850-16 ¹¹ 875-16 ¹¹	3158KT	19026-16 1500	13702-KIT	7955-16	N/A	N/A	N/A	26925TS-KIT	26925TI-KIT
850-16 ¹¹ 875-16 ¹¹	3158KT	19026-16 1500	13702-KIT	7955-16	N/A	N/A	N/A	26925TS-KIT	26925TI-KIT
XFI™ XTREME TRUCK Hydraulic Roller Camshafts									
850-16 ¹¹ 875-16 ¹¹	3158KT	19026-16 1500	13702-KIT	7955-16	26915CS-KIT 26918CS-KIT	26915TS-KIT 26918TS-KIT	26915TI-KIT 26918TI-KIT	26925TS-KIT	26925TI-KIT
850-16 ¹¹ 875-16 ¹¹	3158KT	19026-16 1500	13702-KIT	7955-16	26915CS-KIT 26918CS-KIT	26915TS-KIT 26918TS-KIT	26915TI-KIT 26918TI-KIT	26925TS-KIT	26925TI-KIT
850-16 ¹¹ 875-16 ¹¹	3158KT	19026-16 1500	13702-KIT	7955-16	26915CS-KIT 26918CS-KIT	26915TS-KIT 26918TS-KIT	26915TI-KIT 26918TI-KIT	26925TS-KIT	26925TI-KIT

RED NUMBERS DENOTE PREMIUM OPTION



GM LS GEN III/IV THREE-BOLT 8 CYL. 1997-PRESENT (CONTINUED)

APPLICATIONS/CAMSHAFTS	VALVE SETTING		RPM OPERATING RANGE	CAM PART #	CAM GRIND #	DURATION				VALVE LIFT		LOBE SEP. ANGLE
	IN.	EX.				ADVERTISED		@ .050"		W/ 1.6 ROCKER		
						IN.	EX.	IN.	EX.	IN.	EX.	
TRI-POWER XTREME™ Hydraulic Roller Camshafts												
HYDRAULIC ROLLER – Optimized fuel mileage with good torque and horsepower. Needs programmer.	Hyd.	Hyd.	800 to 5800	54-525-11⁷	TPX 246HR-17	246	258	194	206	.500	.493	117°
HYDRAULIC ROLLER – Exceptional torque with good hp and moderate fuel economy. Needs programmer.	Hyd.	Hyd.	1000 to 6000	54-530-11⁷	TPX 254HR-16	254	264	202	212	.507	.500	116°
HYDRAULIC ROLLER – Optimized hp with good torque & average fuel economy. Programmer required.	Hyd.	Hyd.	1200 to 6200	54-535-11⁷	TPX 262HR-15	262	270	210	218	.513	.507	115°
THUMPR™ Hydraulic Roller Camshafts												
HYDRAULIC ROLLER – Thumpr™ – High performance street, stock converter ok, best with 2000+ converter and gears, choppy/thumping idle.	Hyd.	Hyd.	2000 to 6400	54-600-11⁷	275THR9	275	295	219	233	.553	.536	109°
HYDRAULIC ROLLER – Mutha' Thumpr™ – High performance street/strip, needs 9:1 compression, 2500+ stall, intake, gears and headers, rough idle.	Hyd.	Hyd.	2300 to 6600	54-601-11⁷	283THR9	283	303	227	241	.563	.546	109°
HYDRAULIC ROLLER – Big Mutha' Thumpr™ – Street/strip, needs 9.5:1 compression, 2800+ stall, intake, gears and headers, very rough idle.	Hyd.	Hyd.	2600 to 6800	54-602-11⁷	291THR9	291	311	235	249	.573	.558	109°
LS_R™ CATHEDRAL PORT Hydraulic Roller Camshafts												
Small Displacement or Max Torque, 4.8L-5.7L												
HYDRAULIC ROLLER – Very strong torque and excellent response. Works best in heavy vehicles, low RPM applications.	Hyd.	Hyd.	1300 to 6500	54-455-11⁷	265Lr HR12	265	273	215	233	.604	.610	112°
HYDRAULIC ROLLER – Great torque w/ a very broad power band. Great for street performance & drivability.	Hyd.	Hyd.	1500 to 6700	54-456-11⁷	269Lr HR12	269	277	219	227	.607	.614	112°
HYDRAULIC ROLLER – Steady power throughout broad range. Needs aftermarket airflow improvements on inlet and exhaust.	Hyd.	Hyd.	1700 to 6800	54-457-11⁷	273Lr HR12	273	281	223	231	.610	.617	112°
HYDRAULIC ROLLER – Good street/strip camshaft with wide range. Must have substantial airflow upgrades, inlet and exhaust.	Hyd.	Hyd.	1900 to 7000	54-458-11⁷	277Lr HR13	277	285	227	235	.614	.621	113°
LS_R™ CATHEDRAL PORT Hydraulic Roller Camshafts												
All Out Power for 5.7L-6.2L												
HYDRAULIC ROLLER – Very wide power range and excellent mid-range torque for LS engines with cathedral port cylinder heads.	Hyd.	Hyd.	2000 to 7000	54-459-11⁷	281LR HR13	281	289	231	239	.617	.624	113°
HYDRAULIC ROLLER – Very strong from mid-range to high end torque and horsepower for LS engines with cathedral port cylinder heads.	Hyd.	Hyd.	2200 to 7200	54-460-11⁷	285LR HR13	285	293	235	243	.621	.624	113°
HYDRAULIC ROLLER – Broad top end power range for high RPM, race only LS engines with aftermarket cathedral port cylinder heads and higher compression.	Hyd.	Hyd.	2400 to 7200	54-461-11⁷	289LR HR14	289	297	239	247	.624	.624	114°
HYDRAULIC ROLLER – Excellent top end and high RPM power for race style LS engines with aftermarket cathedral port cylinder heads.	Hyd.	Hyd.	2600 to 7200	54-462-11⁷	293LR HR14	293	301	243	251	.624	.624	114°

⁷ Stock springs cannot be used

¹¹ Lifters only, does not include lifter retainers or guides

GM LS GEN III/IV THREE-BOLT 8 CYL. 1997-PRESENT (CONTINUED)

CAMSHAFTS GENERAL MOTORS

LIFTERS	TIMING SET	ROCKER ARMS & KITS	ROCKER TRUNION UPGRADE KIT	PUSHRODS	BEEHIVE™ VALVE SPRING KITS RETAINER MATERIAL			DUAL VALVE SPRING KITS RETAINER MATERIAL		
					STEEL	TOOL STEEL	TITANIUM	TOOL STEEL	TITANIUM	
TRI-POWER XTREME™ Hydraulic Roller Camshafts										
850-16 ¹¹ 875-16 ¹¹	3158KT	19026-16 1500	13702-KIT	7955-16	26915CS-KIT 26918CS-KIT	26915TS-KIT 26918TS-KIT	26915TI-KIT 26918TI-KIT	26925TS-KIT	26925TI-KIT	
850-16 ¹¹ 875-16 ¹¹	3158KT	19026-16 1500	13702-KIT	7955-16	26915CS-KIT 26918CS-KIT	26915TS-KIT 26918TS-KIT	26915TI-KIT 26918TI-KIT	26925TS-KIT	26925TI-KIT	
850-16 ¹¹ 875-16 ¹¹	3158KT	19026-16 1500	13702-KIT	7955-16	26915CS-KIT 26918CS-KIT	26915TS-KIT 26918TS-KIT	26915TI-KIT 26918TI-KIT	26925TS-KIT	26925TI-KIT	
THUMPR™ Hydraulic Roller Camshafts										
850-16 ¹¹ 875-16 ¹¹	3158KT	19026-16 1500	13702-KIT	7955-16	26918CS-KIT	26918TS-KIT	26918TI-KIT	26925TS-KIT	26925TI-KIT	
850-16 ¹¹ 875-16 ¹¹	3158KT	19026-16 1500	13702-KIT	7955-16	26918CS-KIT	26918TS-KIT	26918TI-KIT	26925TS-KIT	26925TI-KIT	
850-16 ¹¹ 875-16 ¹¹	3158KT	19026-16 1500	13702-KIT	7955-16	26918CS-KIT	26918TS-KIT	26918TI-KIT	26925TS-KIT	26925TI-KIT	
LS_R™ CATHEDRAL PORT Hydraulic Roller Camshafts										
850-16 ¹¹ 15850-16 ¹¹ 15956-16	3158KT	19026-16 1500	13702-KIT	7955-16	N/A	N/A	N/A	26926TS-KIT	26926TI-KIT	
850-16 ¹¹ 15850-16 ¹¹ 15956-16	3158KT	19026-16 1500	13702-KIT	7955-16	N/A	N/A	N/A	26926TS-KIT	26926TI-KIT	
850-16 ¹¹ 15850-16 ¹¹ 15956-16	3158KT	19026-16 1500	13702-KIT	7955-16	N/A	N/A	N/A	26926TS-KIT	26926TI-KIT	
850-16 ¹¹ 15850-16 ¹¹ 15956-16	3158KT	19026-16 1500	13702-KIT	7955-16	N/A	N/A	N/A	26926TS-KIT	26926TI-KIT	
LS_R™ CATHEDRAL PORT Hydraulic Roller Camshafts										
15850-16 ¹¹ 15956-16	3158KT	19026-16 1500	13702-KIT	7955-16	N/A	N/A	N/A	26926TS-KIT	26926TI-KIT	
15850-16 ¹¹ 15956-16	3158KT	19026-16 1500	13702-KIT	7955-16	N/A	N/A	N/A	26926TS-KIT	26926TI-KIT	
15850-16 ¹¹ 15956-16	3158KT	19026-16 1500	13702-KIT	7955-16	N/A	N/A	N/A	26926TS-KIT	26926TI-KIT	
15850-16 ¹¹ 15956-16	3158KT	19026-16 1500	13702-KIT	7955-16	N/A	N/A	N/A	26926TS-KIT	26926TI-KIT	

RED NUMBERS DENOTE PREMIUM OPTION

GM LS GEN III/IV THREE-BOLT 8 CYL. 1997-PRESENT (CONTINUED)

APPLICATIONS/CAMSHAFTS	VALVE SETTING		RPM OPERATING RANGE	CAM PART #	CAM GRIND #	DURATION				VALVE LIFT		LOBE SEP. ANGLE
	IN.	EX.				IN.	EX.	@ .050"	W/ 1.7 ROCKER	IN.	EX.	
LSTM CATHEDRAL PORT Hydraulic Roller Camshafts												
For Large Displacement Only, 6.2L-7.4L												
HYDRAULIC ROLLER – 400+c.i., high RPM applications with major modifications and cathedral port cylinder heads.	Hyd.	Hyd.	2400 to 7000	54-463-11⁷	297LRx HR14	297	305	247	255	.624	.624	114°
HYDRAULIC ROLLER – 420+c.i., high compression, high RPM, cathedral CNC-ported heads in race type applications.	Hyd.	Hyd.	2600 to 7000	54-464-11⁷	301LRx HR15	301	309	251	259	.624	.624	115°
HYDRAULIC ROLLER – 440+c.i., purpose built applications focusing on power above 6000 RPM with cathedral port heads.	Hyd.	Hyd.	2800 to 7200	54-465-11⁷	305LRx HR15	305	313	255	263	.624	.624	115°
HYDRAULIC ROLLER – All out power for extreme displacement race application engines with cathedral port cylinder heads.	Hyd.	Hyd.	3000 to 7200	54-466-11⁷	309LRx HR15	309	317	259	267	.624	.624	115°
LSTM RECTANGULAR PORT Hydraulic Roller Camshafts												
All Out Power for 5.7L-6.2L												
HYDRAULIC ROLLER – Excellent torque with a very broad power band. Great for street performance & drivability.	Hyd.	Hyd.	1500 to 6700	54-453-11	269LRR HR13	269	285	219	235	.607	.621	113°
HYDRAULIC ROLLER – Good street/strip camshaft with very wide range.	Hyd.	Hyd.	1900 to 7000	54-454-11	277LRR HR13	277	293	227	243	.614	.624	113°
HYDRAULIC ROLLER – Very wide power range and excellent mid-range torque for LS engines with rectangular port cylinder heads.	Hyd.	Hyd.	2000 to 7000	54-469-11⁷	281LRR HR13	281	297	231	247	.617	.624	113°
HYDRAULIC ROLLER – Very strong from mid-range to high end torque and horsepower for LS engines with rectangular port cylinder heads.	Hyd.	Hyd.	2200 to 7200	54-470-11⁷	285LRR HR13	285	301	235	251	.621	.624	113°
HYDRAULIC ROLLER – Broad top end power range for high RPM, race only LS engines with aftermarket rectangular port heads and higher compression.	Hyd.	Hyd.	2400 to 7200	54-471-11⁷	289LRR HR14	289	305	239	255	.624	.624	114°
HYDRAULIC ROLLER – Excellent top end and high RPM power for race style LS engines with aftermarket rectangular port cylinder heads.	Hyd.	Hyd.	2600 to 7200	54-472-11⁷	293LRR HR14	293	309	243	259	.624	.624	114°
LSTM RECTANGULAR PORT Hydraulic Roller Camshafts												
For Large Displacement Only, 6.2L-7.4L												
HYDRAULIC ROLLER – 400+c.i., high RPM applications with major modifications and rectangular port cylinder heads.	Hyd.	Hyd.	2400 to 7000	54-473-11⁷	297LRR HR14	297	313	247	263	.624	.624	114°
HYDRAULIC ROLLER – 420+c.i., high compression, high RPM, rectangular CNC-ported heads in race type applications.	Hyd.	Hyd.	2600 to 7000	54-474-11⁷	301LRR HR15	301	317	251	267	.624	.624	115°
HYDRAULIC ROLLER – 440+c.i., purpose built applications focusing on power above 6000 RPM with rectangular port heads.	Hyd.	Hyd.	2800 to 7200	54-475-11⁷	305LRR HR15	305	321	255	271	.624	.624	115°
HYDRAULIC ROLLER – All out power for extreme displacement race application engines with rectangular port cylinder heads.	Hyd.	Hyd.	3000 to 7200	54-476-11⁷	309LRR HR15	309	325	259	275	.624	.624	115°

⁷ Stock springs cannot be used

¹¹ Lifters only, does not include lifter retainers or guides

GM LS GEN III/IV THREE-BOLT 8 CYL. 1997-PRESENT (CONTINUED)

CAMSHAFTS GENERAL MOTORS

LIFTERS	TIMING SET	ROCKER ARMS & KITS	ROCKER TRUNION UPGRADE KIT	PUSHRODS	BEEHIVE™ VALVE SPRING KITS RETAINER MATERIAL			DUAL VALVE SPRING KITS RETAINER MATERIAL	
					STEEL	TOOL STEEL	TITANIUM	TOOL STEEL	TITANIUM
LS_R™ CATHEDRAL PORT Hydraulic Roller Camshafts									
15850-16 ¹¹ 15956-16	3158KT	19026-16 1500	13702-KIT	7955-16	N/A	N/A	N/A	26926TS-KIT	26926TI-KIT
15850-16 ¹¹ 15956-16	3158KT	19026-16 1500	13702-KIT	7955-16	N/A	N/A	N/A	26926TS-KIT	26926TI-KIT
15850-16 ¹¹ 15956-16	3158KT	19026-16 1500	13702-KIT	7955-16	N/A	N/A	N/A	26926TS-KIT	26926TI-KIT
15850-16 ¹¹ 15956-16	3158KT	19026-16 1500	13702-KIT	7955-16	N/A	N/A	N/A	26926TS-KIT	26926TI-KIT
LS_R™ RECTANGULAR PORT Hydraulic Roller Camshafts									
850-16 ¹¹ 15850-16 ¹¹ 15956-16	3158KT	19026-16 1500	13702-KIT	7955-16	N/A	N/A	N/A	26926TS-KIT	26926TI-KIT
850-16 ¹¹ 15850-16 ¹¹ 15956-16	3158KT	19026-16 1500	13702-KIT	7955-16	N/A	N/A	N/A	26926TS-KIT	26926TI-KIT
850-16 ¹¹ 15850-16 ¹¹ 15956-16	3158KT	19026-16 1500	13702-KIT	7955-16	N/A	N/A	N/A	26926TS-KIT	26926TI-KIT
15850-16 ¹¹ 15956-16	3158KT	19026-16 1500	13702-KIT	7955-16	N/A	N/A	N/A	26926TS-KIT	26926TI-KIT
15850-16 ¹¹ 15956-16	3158KT	19026-16 1500	13702-KIT	7955-16	N/A	N/A	N/A	26926TS-KIT	26926TI-KIT
15850-16 ¹¹ 15956-16	3158KT	19026-16 1500	13702-KIT	7955-16	N/A	N/A	N/A	26926TS-KIT	26926TI-KIT
LS_R™ RECTANGULAR PORT Hydraulic Roller Camshafts									
15850-16 ¹¹ 15956-16	3158KT	19026-16 1500	13702-KIT	7955-16	N/A	N/A	N/A	26926TS-KIT	26926TI-KIT
15850-16 ¹¹ 15956-16	3158KT	19026-16 1500	13702-KIT	7955-16	N/A	N/A	N/A	26926TS-KIT	26926TI-KIT
15850-16 ¹¹ 15956-16	3158KT	19026-16 1500	13702-KIT	7955-16	N/A	N/A	N/A	26926TS-KIT	26926TI-KIT
15850-16 ¹¹ 15956-16	3158KT	19026-16 1500	13702-KIT	7955-16	N/A	N/A	N/A	26926TS-KIT	26926TI-KIT

RED NUMBERS DENOTE PREMIUM OPTION

GM LS GEN III/IV THREE-BOLT 8 CYL. 1997-PRESENT (CONTINUED)

APPLICATIONS/CAMSHAFTS	VALVE SETTING		RPM OPERATING RANGE	CAM PART #	CAM GRIND #	DURATION				VALVE LIFT		LOBE SEP. ANGLE
	IN.	EX.				IN.	EX.	IN.	EX.	IN.	EX.	
LS[™] CENTRIFUGAL BLOWER Hydraulic Roller Camshafts												
HYDRAULIC ROLLER – Strong mid-range power when used with a centrifugal blower.	Hyd.	Hyd.	2200 to 7000	54-477-11⁷	277LCB HR14	277	293	227	243	.614	.624	114°
HYDRAULIC ROLLER – Good high RPM power when used with a centrifugal blower.	Hyd.	Hyd.	2500 to 7200	54-478-11⁷	285LCB HR15	285	301	235	251	.621	.624	115°
HYDRAULIC ROLLER – Best cam for high RPM power in race application when using a centrifugal blower.	Hyd.	Hyd.	3000 to 7200	54-479-11⁷	293LCB HR16	293	309	243	259	.624	.624	116°
LS[™] ROOTS BLOWER Hydraulic Roller Camshafts												
HYDRAULIC ROLLER – Best in street/strip LS applications equipped with a Roots type supercharger.	Hyd.	Hyd.	2400 to 7000	54-467-11⁷	289LRB HR14	289	293	239	243	.624	.624	114°
HYDRAULIC ROLLER – Designed for race applications with a Roots blower. Very strong high RPM power.	Hyd.	Hyd.	2700 to 7200	54-468-11⁷	297LRB HR14	297	301	247	251	.624	.624	114°
LS[™] TURBO Hydraulic Roller Camshafts (Remote Mount)												
HYDRAULIC ROLLER – Good responsiveness and excellent power when used with a remote mount turbo system.	Hyd.	Hyd.	2200 to 7000	54-480-11⁷	277LTB HR15	277	273	227	223	.614	.610	115°
HYDRAULIC ROLLER – High RPM street/strip applications using a remote mount turbo system.	Hyd.	Hyd.	2700 to 7200	54-481-11⁷	285LTB HR15	285	281	235	231	.621	.617	115°

APPLICATIONS/CAMSHAFTS	VALVE SETTING		RPM OPERATING RANGE	CAM PART #	CAM GRIND #	DURATION				VALVE LIFT		LOBE SEP. ANGLE
	IN.	EX.				IN.	EX.	IN.	EX.	IN.	EX.	
XFI[™] SOLID ROLLER Mechanical Roller Camshafts												
MECHANICAL ROLLER – High performance street, excellent torque and mid-range power. Programmer and valve spring upgrade required.	.016	.018	1800 to 6400	54-500-11⁷	XFI2700113	270	277	235	240	.646	.641	113°
MECHANICAL ROLLER – Street/strip, superb mid and upper RPM power. Intake upgrade recommended. Programmer and valve spring upgrade required.	.016	.018	2100 to 6700	54-501-11⁷	XFI278R113	278	285	243	248	.653	.648	113°
MECHANICAL ROLLER – High RPM street/strip camshaft for large c.i. Gen III applications. Intake upgrade strongly recommended. Programmer and valve spring upgrade required.	.016	.018	2400 to 7000	54-502-11⁷	XFI286R113	286	293	251	256	.660	.655	113°

GM LS2/LS3 GEN IV SINGLE-BOLT W/O VVT & AFM 8 CYL. 2005-PRESENT

APPLICATIONS/CAMSHAFTS	VALVE SETTING		RPM OPERATING RANGE	CAM PART #	CAM GRIND #	DURATION				VALVE LIFT		LOBE SEP. ANGLE
	IN.	EX.				IN.	EX.	IN.	EX.	IN.	EX.	
XFI[™] Hydraulic Roller Camshafts												
HYDRAULIC ROLLER – Great street/strip camshaft for mid-range & high RPM power. Must have programmer.	Hyd.	Hyd.	1800 to 6800	146-426-11⁷	XR275HR13	275	287	222	234	.566	.576	113°
HYDRAULIC ROLLER – High RPM street/strip cam for use with FAST [™] intake. Requires programmer.	Hyd.	Hyd.	2200 to 7200	146-428-11⁷	XR281HR13	281	293	228	240	.571	.590	113°
LS[™] (Turbo Remote Mount)												
HYDRAULIC ROLLER - Good responsiveness & excellent power when used w/ a remote mount turbo system.	Hyd.	Hyd.	2200 to 7000	146-480-11	277LTB HR15	277	273	227	223	.614	.610	115°
HYDRAULIC ROLLER - High RPM street/strip applications using a remote mount turbo system.	Hyd.	Hyd.	2700 to 7200	146-481-11	285LTB HR15	285	281	235	231	.621	.617	115°

⁷ Stock springs cannot be used¹¹ Lifters only, does not include lifter retainers or guides

GM LS GEN III/IV THREE-BOLT 8 CYL. 1997-PRESENT (CONTINUED)

LIFTERS	TIMING SET	ROCKER ARMS & KITS	ROCKER TRUNION UPGRADE KIT	PUSHRODS	BEEHIVE™ VALVE SPRING KITS RETAINER MATERIAL			DUAL VALVE SPRING KITS RETAINER MATERIAL	
					STEEL	TOOL STEEL	TITANIUM	TOOL STEEL	TITANIUM
LS_R™ CENTRIFUGAL BLOWER Hydraulic Roller Camshafts									
15850-16 ¹¹ 15956-16	3158KT	1500 1521	13702-KIT	7955-16	N/A	N/A	N/A	26926TS-KIT	26926TI-KIT
15850-16 ¹¹ 15956-16	3158KT	1500 1521	13702-KIT	7955-16	N/A	N/A	N/A	26926TS-KIT	26926TI-KIT
15850-16 ¹¹ 15956-16	3158KT	1500 1521	13702-KIT	7955-16	N/A	N/A	N/A	26926TS-KIT	26926TI-KIT
LS_R™ ROOTS BLOWER Hydraulic Roller Camshafts									
15850-16 ¹¹ 15956-16	3158KT	1500 1521	13702-KIT	7955-16	N/A	N/A	N/A	26926TS-KIT	26926TI-KIT
15850-16 ¹¹ 15956-16	3158KT	1500 1521	13702-KIT	7955-16	N/A	N/A	N/A	26926TS-KIT	26926TI-KIT
LS_R™ TURBO Hydraulic Roller Camshafts (Remote Mount)									
15850-16 ¹¹ 15956-16	3158KT	1500 1521	13702-KIT	7955-16	N/A	N/A	N/A	26926TS-KIT	26926TI-KIT
15850-16 ¹¹ 15956-16	3158KT	1500 1521	13702-KIT	7955-16	N/A	N/A	N/A	26926TS-KIT	26926TI-KIT
LIFTERS	TIMING SET	ROCKER ARMS	ROCKER TRUNION UPGRADE KIT	PUSHRODS	BEEHIVE™ VALVE SPRING KITS RETAINER MATERIAL			DUAL VALVE SPRING KITS RETAINER MATERIAL	
					STEEL	TOOL STEEL	TITANIUM	TOOL STEEL	TITANIUM
XFI™ SOLID ROLLER Mechanical Roller Camshafts									
8956-16	3158KT	1500 1521	13702-KIT	7955-16	N/A	N/A	N/A	26926TS-KIT	26926TI-KIT
8956-16	3158KT	1500 1521	13702-KIT	7955-16	N/A	N/A	N/A	26926TS-KIT	26926TI-KIT
8956-16	3158KT	1500 1521	13702-KIT	7955-16	N/A	N/A	N/A	26926TS-KIT	26926TI-KIT

GM LS2/LS3 GEN IV SINGLE-BOLT W/O VVT & AFM 8 CYL. 2005-PRESENT

LIFTERS	TIMING SET	ROCKER ARMS & KITS	ROCKER TRUNION UPGRADE KIT	PUSHRODS	BEEHIVE™ VALVE SPRING KITS RETAINER MATERIAL			DUAL VALVE SPRING KITS RETAINER MATERIAL	
					STEEL	TOOL STEEL	TITANIUM	TOOL STEEL	TITANIUM
XFI™ Hydraulic Roller Camshafts									
850-16 ¹¹ 875-16 ¹¹	7107	19026-16 19030-16	13702-KIT	7955-16	26918C5-KIT	26918C5-KIT	26918C5-KIT	26925TS-KIT	26925TI-KIT
850-16 ¹¹ 875-16 ¹¹	7107	19026-16 19030-16	13702-KIT	7955-16	26918C5-KIT	26918C5-KIT	26918C5-KIT	26925TS-KIT	26925TI-KIT
LS_R™ (Turbo Remote Mount)									
15850-16 ¹¹ 15956-16	7107	19026-16 19030-16	13702-KIT	7955-16	N/A	N/A	N/A	26926TS-KIT	26926TI-KIT
15850-16 ¹¹ 15956-16	7107	19026-16 19030-16	13702-KIT	7955-16	N/A	N/A	N/A	26926TS-KIT	26926TI-KIT

RED NUMBERS DENOTE PREMIUM OPTION



GM LS2/LS3 GEN IV SINGLE-BOLT W/O VVT & AFM 8 CYL. 2005-PRESENT (CONTINUED)

APPLICATIONS/CAMSHAFTS	VALVE SETTING		RPM OPERATING RANGE	CAM PART #	CAM GRIND #	DURATION				VALVE LIFT		LOBE SEP. ANGLE
	IN.	EX.				ADVERTISED IN.	EX.	@ .050" IN.	EX.	W/ 1.7 ROCKER IN.	EX.	
LS[™] Hydraulic Roller Camshafts												
HYDRAULIC ROLLER – Excellent torque w/ a very broad power band. Great for street performance & drivability.	Hyd.	Hyd.	1500 to 6700	146-456-11⁷	269LrR HR13	269	285	219	235	.607	.621	113°
HYDRAULIC ROLLER – Good street/strip camshaft with wide range.	Hyd.	Hyd.	1900 to 7000	146-458-11⁷	277LrR HR13	277	293	227	243	.614	.624	113°
HYDRAULIC ROLLER – Very strong from mid-range to high end torque and hp for single-bolt LS3.	Hyd.	Hyd.	2200 to 7200	146-460-11⁷	285LrR HR13	285	301	235	251	.621	.624	113°
HYDRAULIC ROLLER – Broad top end power range for high RPM race only, single-bolt LS3 applications.	Hyd.	Hyd.	2400 to 7200	146-461-11⁷	289LrR HR14	289	305	239	255	.624	.624	114°
HYDRAULIC ROLLER – Excellent top end and high RPM power for race applications using the single-bolt LS3.	Hyd.	Hyd.	2600 to 7200	146-462-11⁷	293LrR HR14	293	309	243	259	.624	.624	114°

GM LS2/LS3 GEN IV SINGLE-BOLT W/ AFM, W/O VVT 8 CYL. 2005-2008

APPLICATIONS/CAMSHAFTS	VALVE SETTING		RPM OPERATING RANGE	CAM PART #	CAM GRIND #	DURATION				VALVE LIFT		LOBE SEP. ANGLE
	IN.	EX.				ADVERTISED IN.	EX.	@ .050" IN.	EX.	W/ 1.7 ROCKER IN.	EX.	
XFI[™] AFM Hydraulic Roller Camshafts												
HYDRAULIC ROLLER - Great all around torque for trucks and other heavy applications; across the board improvements power over stock AFM cams.	Hyd.	Hyd.	1600 to 6300	646-431-13	262AFM15	275 D	286 D	212 D	224 D	.500 D	.500 D	115°
						262 N	274 N	210 N	222 N	.500 N	.500 N	115°
HYDRAULIC ROLLER - Excellent performance gains over the widest possible range in modified applications like a G8 with manifold and headers.	Hyd.	Hyd.	1900 to 6500	646-432-13	266AFM16	278 D	290 D	216 D	228 D	.500 D	.500 D	116°
						266 N	278 N	214 N	226 N	.500 N	.500 N	116°
HYDRAULIC ROLLER - Outstanding top end power in modified AFM engines, requires higher stall, gears, headers, ect for best performance.	Hyd.	Hyd.	2100 to 6700	646-433-13	270AFM17	282 D	294 D	220 D	232 D	.500 D	.500 D	117°
						270 N	282 N	218 N	230 N	.500 N	.500 N	117°

GM LS GEN IV SINGLE-BOLT W/ VVT, W/O AFM (12585994) 8 CYL. 2005-2008

APPLICATIONS/CAMSHAFTS	VALVE SETTING		RPM OPERATING RANGE	CAM PART #	CAM GRIND #	DURATION				VALVE LIFT		LOBE SEP. ANGLE
	IN.	EX.				ADVERTISED IN.	EX.	@ .050" IN.	EX.	W/ 1.7 ROCKER IN.	EX.	
XFI[™] RPM HI-LIFT Hydraulic Roller Camshafts												
HYDRAULIC ROLLER – Excellent responsiveness and low end torque with good power gains.	Hyd.	Hyd.	1300 to 6500	156-400-13	263PHR14	263	277	210	224	.556	.568	114°
HYDRAULIC ROLLER – Substantial power and torque gains across the board.	Hyd.	Hyd.	1600 to 6700	156-401-13	267PHR14	267	281	214	228	.559	.571	114°
HYDRAULIC ROLLER – Extremely strong from 4500 past 6700 RPM. Noticeable idle.	Hyd.	Hyd.	1800 to 6900	156-402-13	271PHR14	271	285	218	232	.563	.575	114°
HYDRAULIC ROLLER – Best choice for maximum power in aftermarket/CNC head applications.	Hyd.	Hyd.	2000 to 7100	156-403-13	275PHR14	275	289	222	236	.566	.578	114°

⁷ Stock springs cannot be used

¹¹ Lifters only, does not include lifter retainers or guides

GM LS2/LS3 GEN IV SINGLE-BOLT W/O VVT & AFM 8 CYL. 2005-PRESENT (CONTINUED)

LIFTERS	TIMING SET	ROCKER ARMS & KITS	TRUNION UPGRADE KIT	PUSHRODS	BEEHIVE™ VALVE SPRING KITS RETAINER MATERIAL			DUAL VALVE SPRING KITS RETAINER MATERIAL		
					STEEL	TOOL STEEL	TITANIUM	TOOL STEEL	TITANIUM	
LS_R™ Hydraulic Roller Camshafts										
850-16 ¹¹ 875-16 ¹¹	7107	19026-16 19030-16	13702-KIT	7955-16	N/A	N/A	N/A	26926TS-KIT	26926TI-KIT	
850-16 ¹¹ 875-16 ¹¹	7107	19026-16 19030-16	13702-KIT	7955-16	N/A	N/A	N/A	26926TS-KIT	26926TI-KIT	
15850-16 ¹¹ 15956-16	7107	19026-16 19030-16	13702-KIT	7955-16	N/A	N/A	N/A	26926TS-KIT	26926TI-KIT	
15850-16 ¹¹ 15956-16	7107	19026-16 19030-16	13702-KIT	7955-16	N/A	N/A	N/A	26926TS-KIT	26926TI-KIT	
15850-16 ¹¹ 15956-16	7107	19026-16 19030-16	13702-KIT	7955-16	N/A	N/A	N/A	26926TS-KIT	26926TI-KIT	

GM LS2/LS3 GEN IV SINGLE-BOLT W/ AFM, W/O VVT 8 CYL. 2005-2008

LIFTERS	TIMING SET	ROCKER ARMS & KITS	TRUNION UPGRADE KIT	PUSHRODS	BEEHIVE™ VALVE SPRING KITS RETAINER MATERIAL			DUAL VALVE SPRING KITS RETAINER MATERIAL		
					STEEL	TOOL STEEL	TITANIUM	TOOL STEEL	TITANIUM	
XFI™ AFM Hydraulic Roller Camshafts										
N/A	7107	19026-16 19030-16	13702-KIT	7955-16	26918CS-KIT	26918TS-KIT	26918TI-KIT	26925TS-KIT	26925TI-KIT	
N/A	7107	19026-16 19030-16	13702-KIT	7955-16	26918CS-KIT	26918TS-KIT	26918TI-KIT	26925TS-KIT	26925TI-KIT	
N/A	7107	19026-16 19030-16	13702-KIT	7955-16	26918CS-KIT	26918TS-KIT	26918TI-KIT	26925TS-KIT	26925TI-KIT	

GM LS GEN IV SINGLE-BOLT W/ VVT, W/O AFM (12585994) 8 CYL. 2005-2008

LIFTERS	PHASER LIMITER KIT	ROCKER ARMS & KITS	TRUNION UPGRADE KIT	PUSHRODS	BEEHIVE™ VALVE SPRING KITS RETAINER MATERIAL			DUAL VALVE SPRING KITS RETAINER MATERIAL		
					STEEL	TOOL STEEL	TITANIUM	TOOL STEEL	TITANIUM	
XFI™ RPM HI-LIFT Hydraulic Roller Camshafts										
850-16	5456	19026-16 19030-16	13702-KIT	7955-16	26918CS-KIT	26918TS-KIT	26918TI-KIT	26925TS-KIT	26925TI-KIT	
850-16	5456	19026-16 19030-16	13702-KIT	7955-16	26918CS-KIT	26918TS-KIT	26918TI-KIT	26925TS-KIT	26925TI-KIT	
850-16	5456	19026-16 19030-16	13702-KIT	7955-16	26918CS-KIT	26918TS-KIT	26918TI-KIT	26925TS-KIT	26925TI-KIT	
850-16	5456	19026-16 19030-16	13702-KIT	7955-16	26918CS-KIT	26918TS-KIT	26918TI-KIT	26925TS-KIT	26925TI-KIT	

RED NUMBERS DENOTE PREMIUM OPTION



GM LS GEN IV SINGLE-BOLT W/ VVT (12585994) & AFM 8 CYL. 2005-2008

APPLICATIONS/CAMSHAFTS	VALVE SETTING		RPM OPERATING RANGE	CAM PART #	CAM GRIND #	DURATION				VALVE LIFT		LOBE SEP. ANGLE
	IN.	EX.				ADVERTISED		@ .050"		W/ 1.7 ROCKER		
						IN.	EX.	IN.	EX.	IN.	EX.	
XFI™ AFM Hydraulic Roller Camshafts												
HYDRAULIC ROLLER - Best choice for vehicles requiring strong off idle torque, while improving power at all RPM. Great for trucks & heavy cars.	Hyd.	Hyd.	1600 to 6500	656-421-13	266PHR14	278 D	290 D	216 D	228 D	.500 D	.500 D	114°
						266 N	278 N	214 N	226 N	.500 N	.500 N	114°
HYDRAULIC ROLLER - Very impressive mid-range to high RPM power improvements in modified applications with headers, intake and gears.	Hyd.	Hyd.	1800 to 6700	656-422-13	270PHR15	282 D	294 D	220 D	232 D	.500 D	.500 D	115°
						270 N	282 N	218 N	230 N	.500 N	.500 N	115°
HYDRAULIC ROLLER - Outstanding top end power in significantly modified VVT & AFM applications. Best w/ stall, gears, headers & intake mods.	Hyd.	Hyd.	2000 to 6900	656-423-13	274PHR16	286 D	298 D	224 D	236 D	.500 D	.500 D	116°
						274 N	286 N	222 N	234 N	.500 N	.500 N	116°

GM LS GEN IV SINGLE-BOLT W/ VVT (12606358), W/O AFM 8 CYL. 2008-PRESENT

APPLICATIONS/CAMSHAFTS	VALVE SETTING		RPM OPERATING RANGE	CAM PART #	CAM GRIND #	DURATION				VALVE LIFT		LOBE SEP. ANGLE
	IN.	EX.				ADVERTISED		@ .050"		W/ 1.7 ROCKER		
						IN.	EX.	IN.	EX.	IN.	EX.	
XFI™ RPM HI-LIFT Hydraulic Roller Camshafts												
HYDRAULIC ROLLER - Great off idle torque for trucks and other heavy or low RPM applications, while still improving power at all RPM.	Hyd.	Hyd.	1500 to 6600	189-400-13	263PIIHR14	263	277	210	224	.556	.568	114°
HYDRAULIC ROLLER - Excellent responsiveness & mid-range power w/ across the board gains. Best choice for heavy vehicles & stock gearing.	Hyd.	Hyd.	1700 to 6800	189-401-13	267PIIHR14	267	281	214	228	.559	.571	114°
HYDRAULIC ROLLER - Great all around performance and best choice for mildly modified L99 Camaro applications with AFM disabled.	Hyd.	Hyd.	1900 to 7000	189-402-13	271PIIHR14	271	285	218	232	.563	.575	114°
HYDRAULIC ROLLER - Outstanding top end power in modified non-AFM applications, w/o sacrificing low end if properly programmed.	Hyd.	Hyd.	2100 to 7200	189-403-13	275PIIHR14	275	289	222	236	.566	.578	114°
XFI™ VVT Hydraulic Roller Camshafts												
HYDRAULIC ROLLER - Excellent power improvements over stock in modified engines using new more asymmetrical VVI intake profiles.	Hyd.	Hyd.	1700 to 6900	189-424-13	266VI14	266	278	218	230	.612	.609	114°
HYDRAULIC ROLLER - Great choice for max effort VVT street engines; great high RPM power. Higher lift takes full advantage of ported heads.	Hyd.	Hyd.	1900 to 7100	189-426-13	270VI15	270	282	222	234	.615	.612	115°
HYDRAULIC ROLLER - Requires either added displacement or high RPM modifications in street/strip applications. Largest VVT cam w/ stock pistons.	Hyd.	Hyd.	2100 to 7300	189-428-13	274VI16	272	286	226	236	.619	.615	116°

GM LS GEN IV SINGLE-BOLT W/ VVT (12606358) & AFM 8 CYL. 2008-PRESENT

APPLICATIONS/CAMSHAFTS	VALVE SETTING		RPM OPERATING RANGE	CAM PART #	CAM GRIND #	DURATION				VALVE LIFT		LOBE SEP. ANGLE
	IN.	EX.				ADVERTISED		@ .050"		W/ 1.7 ROCKER		
						IN.	EX.	IN.	EX.	IN.	EX.	
XFI™ AFM Hydraulic Roller Camshafts												
HYDRAULIC ROLLER - Excellent responsiveness and mid-range power w/ across the board gains. Best choice for heavy vehicles & stock gearing.	Hyd.	Hyd.	1600 to 6500	689-421-13	266PIIHR14	278 D	290 D	216 D	228 D	.500 D	.500 D	114°
						266 N	278 N	214 N	226 N	.500 N	.500 N	114°
HYDRAULIC ROLLER - Great all around performance and best choice for mildly modified L99 Camaro applications with AFM enabled.	Hyd.	Hyd.	1800 to 6700	689-422-13	270PIIHR15	282 D	294 D	220 D	232 D	.500 D	.500 D	115°
						270 N	282 N	218 N	230 N	.500 N	.500 N	115°
HYDRAULIC ROLLER - Outstanding top end power in modified L99 style applications, w/o sacrificing low end if properly programmed.	Hyd.	Hyd.	2000 to 6900	689-423-13	274PIIHR16	286 D	298 D	224 D	236 D	.500 D	.500 D	116°
						274 N	286 N	222 N	234 N	.500 N	.500 N	116°

GM LS GEN IV SINGLE-BOLT W/ VVT (12585994) & AFM 8 CYL. 2005-2008

LIFTERS	PHASER LIMITER KIT	ROCKER ARMS & KITS	TRUNION UPGRADE KIT	PUSHRODS	BEEHIVE™ VALVE SPRING KITS RETAINER MATERIAL			DUAL VALVE SPRING KITS RETAINER MATERIAL	
					STEEL	TOOL STEEL	TITANIUM	TOOL STEEL	TITANIUM
					XFI™ AFM Hydraulic Roller Camshafts				
N/A	5456	19024-16 19028-16	13702-KIT	7955-16	26918CS-KIT	26918TS-KIT	26918TI-KIT	26925TS-KIT	26925TI-KIT
N/A	5456	19024-16 19028-16	13702-KIT	7955-16	26918CS-KIT	26918TS-KIT	26918TI-KIT	26925TS-KIT	26925TI-KIT
N/A	5456	19024-16 19028-16	13702-KIT	7955-16	26918CS-KIT	26918TS-KIT	26918TI-KIT	26925TS-KIT	26925TI-KIT

GM LS GEN IV SINGLE-BOLT W/ VVT (12606358), W/O AFM 8 CYL. 2008-PRESENT

LIFTERS	PHASER LIMITER KIT	ROCKER ARMS & KITS	TRUNION UPGRADE KIT	PUSHRODS	BEEHIVE™ VALVE SPRING KITS RETAINER MATERIAL			DUAL VALVE SPRING KITS RETAINER MATERIAL	
					STEEL	TOOL	TITANIUM	TOOL STEEL	TITANIUM
					XFI™ RPM HI-LIFT Hydraulic Roller Camshafts				
850-16	5460	19026-16 19030-16	13702-KIT	7955-16	26918CS-KIT	26918TS-KIT	26918TI-KIT	26925TS-KIT	26925TI-KIT
850-16	5460	19026-16 19030-16	13702-KIT	7955-16	26918CS-KIT	26918TS-KIT	26918TI-KIT	26925TS-KIT	26925TI-KIT
850-16	5460	19026-16 19030-16	13702-KIT	7955-16	26918CS-KIT	26918TS-KIT	26918TI-KIT	26925TS-KIT	26925TI-KIT
850-16	5460	19026-16 19030-16	13702-KIT	7955-16	26918CS-KIT	26918TS-KIT	26918TI-KIT	26925TS-KIT	26925TI-KIT
XFI™ VVT Hydraulic Roller Camshafts									
850-16	5460	19026-16 19030-16	13702-KIT	7955-16	N/A	N/A	N/A	26926TS-KIT	26926TI-KIT
850-16	5460	19026-16 19030-16	13702-KIT	7955-16	N/A	N/A	N/A	26926TS-KIT	26926TI-KIT
850-16	5460	19026-16 19030-16	13702-KIT	7955-16	N/A	N/A	N/A	26926TS-KIT	26926TI-KIT

GM LS GEN IV SINGLE-BOLT W/ VVT (12606358) & AFM 8 CYL. 2008-PRESENT

LIFTERS	PHASER LIMITER KIT	ROCKER ARMS & KITS	TRUNION UPGRADE KIT	PUSHRODS	BEEHIVE™ VALVE SPRING KITS RETAINER MATERIAL			DUAL VALVE SPRING KITS RETAINER MATERIAL	
					STEEL	TOOL	TITANIUM	TOOL STEEL	TITANIUM
					XFI™ PII Hydraulic Roller Camshafts				
N/A	5460	19024-16 19028-16	13702-KIT	7955-16	26918CS-KIT	26918TS-KIT	26918TI-KIT	26925TS-KIT	26925TI-KIT
N/A	5460	19024-16 19028-16	13702-KIT	7955-16	26918CS-KIT	26918TS-KIT	26918TI-KIT	26925TS-KIT	26925TI-KIT
N/A	5460	19024-16 19028-16	13702-KIT	7955-16	26918CS-KIT	26918TS-KIT	26918TI-KIT	26925TS-KIT	26925TI-KIT

RED NUMBERS DENOTE PREMIUM OPTION



GM LT1 GEN V W/ VVT & AFM 8 CYL. 2014

APPLICATIONS/CAMSHAFTS	VALVE SETTING		RPM OPERATING RANGE	CAM PART #	CAM GRIND #	DURATION				VALVE LIFT		LOBE SEP. ANGLE
	IN.	EX.				ADVERTISED		@ .050"		W/ 1.8 ROCKER		
						IN.	EX.	IN.	EX.	IN.	EX.	
XFI™ AFM Hydraulic Roller Camshafts												
Larger Cam Lobes For Outboard Cylinders												
HYDRAULIC ROLLER - Strong power gains with Smooth Idle in LT1 w/ DI, VVT & AFM enabled.	Hyd.	Hyd.	1400 to 6500	624-500-13	262PIIHR15	274 D	286 D	212 D	224 D	.572 D	.529 D	115°
						262 N	274 N	210 N	222 N	.572N	.529 N	115°
HYDRAULIC ROLLER - Excellent responsiveness and mid-range power with across the board gains with AFM enabled.	Hyd.	Hyd.	1600 to 6700	624-512-13	266PIIHR16	274 D	286 D	216 D	228 D	.572 D	.529 D	116°
						262 N	274 N	214 N	226 N	.572N	.529 N	116°
HYDRAULIC ROLLER - Great all around performance and best choice for mildly modified LT1 applications with AFM enabled.	Hyd.	Hyd.	1800 to 6900	624-524-13	270PIIHR17	282 D	294 D	220 D	232 D	.572 D	.529 D	117°
						270 N	282 N	218 N	230 N	.572N	.529 N	117°
HYDRAULIC ROLLER - Outstanding top end power in modified LT1 AFM applications w/ only slight low end losses if properly programmed.	Hyd.	Hyd.	2000 to 7100	624-536-13	274PIIHR18	286 D	298 D	224 D	236 D	.572 D	.529 D	118°
						274 N	286 N	222 N	234 N	.572N	.529 N	118°

CHEVROLET 348-409 C.I. 8 CYL. 1958-1965

APPLICATIONS/CAMSHAFTS	VALVE SETTING		RPM OPERATING RANGE	CAM PART #	CAM GRIND #	DURATION				VALVE LIFT		LOBE SEP. ANGLE
	IN.	EX.				ADVERTISED		@ .050"		W/ 1.75 ROCKER		
						IN.	EX.	IN.	EX.	IN.	EX.	
CLASSIC THUMPR™ Hydraulic Flat Tappet Camshafts												
HYDRAULIC – Classic Thumpr™ – Performance street with good low end, stock converter ok, needs gears. Choppy/thumping idle.	Hyd.	Hyd.	1500-5000	48-600-5	279TH7	278	296	226	241	.512	.498	107°
HYDRAULIC – Classic Mutha' Thumpr™ – High performance street/strip, aluminum heads recommended, 2000+ stall, gears and headers, rough idle.	Hyd.	Hyd.	2000-5500	48-601-5	287TH7	286	304	234	249	.525	.509	107°
HYDRAULIC – Classic Big Mutha' Thumpr™ – Street/strip, aluminum heads necessary, 2500+ stall, gears and headers, very rough idle.	Hyd.	Hyd.	2500-6000	48-602-5	295TH7	294	312	242	257	.537	.521	107°
THUMPR™ 4 & 7 SWAP FIRING ORDER Hydraulic Roller Camshafts												
HYDRAULIC ROLLER - Thumpr™ - High performance street, stock converter ok, best with 2000+ converter and gears. Choppy/thumping idle.	Hyd.	Hyd.	2000 to 5800	48-600-10	47S 283THR-8	280	303	227	241	.564	.546	108°
HYDRAULIC ROLLER - Mutha Thumpr™ - High performance street/strip, needs 9:1 compression, 2500+ stall. Intake, gears, and headers. Rough idle.	Hyd.	Hyd.	2200 to 6200	48-601-10	47S 291MTHR-8	291	311	235	249	.574	.558	108°
HYDRAULIC ROLLER - Big Mutha Thumpr™ - Street/strip, needs 9.5:1 compression, 2800+ stall. Intake, gears, and headers. Very rough idle.	Hyd.	Hyd.	2500 to 6400	48-602-10	47S 299BMTHR-8	299	319	243	257	.586	.571	108°
XTREME ENERGY™ Hydraulic Roller Camshafts												
HYDRAULIC ROLLER -Great for street cruiser. Good throttle response in 409. Mild idle quality.	Hyd.	Hyd.	1200 to 5600	48-800-11	XE266HR-10	266	272	212	218	.536	.543	110°
HYDRAULIC ROLLER -Great for street rod. Excellent mid range & passing power. 2000 converter needed. Aftermarket intake & headers will yield best results. 9:1 compression. Mild rough idle.	Hyd.	Hyd.	1400 to 5800	48-801-11	XE272HR-10	272	278	218	224	.543	.550	110°
HYDRAULIC ROLLER -Great for street/strip 409. 2800 converter needed. Aftermarket intake & headers will yield best results. 9.5:1 compression. Rough idle.	Hyd.	Hyd.	1800 to 6200	48-802-11	XE284HR-10	284	290	230	236	.555	.560	110°

GM LT1 GEN V W/ VVT & AFM 8 CYL. 2014

LIFTERS	PHASER LIMITER KIT	TRUNION KIT	ROCKER ARMS & KITS	RPM KITS	PUSHRODS	DUAL VALVE SPRINGS	RETAINERS		VALVE LOCKS	VALVE SEALS	SPRING LOCATORS	
							STEEL	TITANIUM				
XFI™ AFM Hydraulic Roller Camshafts												
N/A	N/A	N/A	N/A	N/A	N/A	N/A	N/A	N/A	N/A	N/A	N/A	N/A
N/A	N/A	N/A	N/A	N/A	N/A	N/A	N/A	N/A	N/A	N/A	N/A	N/A
N/A	N/A	N/A	N/A	N/A	N/A	N/A	N/A	N/A	N/A	N/A	N/A	N/A
N/A	N/A	N/A	N/A	N/A	N/A	N/A	N/A	N/A	N/A	N/A	N/A	N/A

CHEVROLET 348-409 C.I. 8 CYL. 1958-1965

K-KIT	SK-KIT	CL-KIT	LIFTERS	DIST. GEAR	TIMING SET	ROCKER ARMS	PUSHRODS	VALVE SPRINGS	RETAINERS	VALVE LOCKS	VALVE SEALS
CLASSIC THUMPR™ Hydraulic Flat Tappet Camshafts											
N/A	N/A	N/A	812-16	N/A	N/A	1629-16	N/A	N/A	N/A	N/A	N/A
N/A	N/A	N/A	812-16	N/A	N/A	1629-16	N/A	N/A	N/A	N/A	N/A
N/A	N/A	N/A	812-16	N/A	N/A	1629-16	N/A	N/A	N/A	N/A	N/A
THUMPR™ 4 & 7 SWAP FIRING ORDER Hydraulic Roller Camshafts											
N/A	N/A	N/A	8959-16	N/A	N/A	1629-16	N/A	N/A	N/A	N/A	N/A
N/A	N/A	N/A	8959-16	N/A	N/A	1629-16	N/A	N/A	N/A	N/A	N/A
N/A	N/A	N/A	8959-16	N/A	N/A	1629-16	N/A	N/A	N/A	N/A	N/A
XTREME ENERGY™ Hydraulic Roller Camshafts											
N/A	N/A	N/A	8959-16	N/A	N/A	1629-16	N/A	N/A	N/A	N/A	N/A
N/A	N/A	N/A	8959-16	N/A	N/A	1629-16	N/A	N/A	N/A	N/A	N/A
N/A	N/A	N/A	8959-16	N/A	N/A	1629-16	N/A	N/A	N/A	N/A	N/A

RED NUMBERS DENOTE PREMIUM OPTION

CHEVROLET 396-454 C.I. 8 CYL. 1967-1996

APPLICATIONS/CAMSHAFTS	VALVE SETTING		RPM OPERATING RANGE	CAM PART #	CAM GRIND #	DURATION				VALVE LIFT		LOBE SEP. ANGLE
	IN.	EX.				IN.	EX.	IN.	EX.	IN.	EX.	
HIGH ENERGY™ Hydraulic Flat Tappet Camshafts												
HYDRAULIC – Strong low speed torque, good economy. Best in 396-402c.i., stock transmission and gear ratios. Very smooth idle.	Hyd.	Hyd.	800 to 4800	11-202-3	252H	252	252	206	206	.460	.460	110°
HYDRAULIC – Good torque and power. Excellent towing in 454c.i. w/ manual or automatic, 3.73+ axle ratios. Smooth idle.	Hyd.	Hyd.	1200 to 5200	11-203-3	260H	260	260	212	212	.475	.475	110°
HYDRAULIC – Performance with slight rough idle in 396. Great for heavy towing in 454c.i.	Hyd.	Hyd.	1500 to 5500	11-205-3	268H	268	268	218	218	.485	.485	110°
MAGNUM Hydraulic Flat Tappet Camshafts												
HYDRAULIC – Good for daily driven street machine, works with stock converter, likes headers. 396c.i. needs 3.55-3.73 gear and 1800+ stall. Slight rough idle.	Hyd.	Hyd.	1500 to 5800	11-207-3	270H	270	270	224	224	.510	.510	110°
HYDRAULIC – Great for street machines. Use headers and 9:1+ compression. In 396-402c.i. use 2500+ stall, lower gears. Rough idle.	Hyd.	Hyd.	2000 to 6000	11-208-3	280H	280	280	230	230	.520	.520	110°
HYDRAULIC – Needs 9.5:1 compression, 2800+ stall, headers and lower gears. Choppy idle.	Hyd.	Hyd.	2200 to 6200	11-318-4	286H	286	286	236	236	.556	.556	110°
HYDRAULIC – Street/strip applications. 10:1+ compression, 3000+ stall or 4 speed. 4.10 or lower gears and aftermarket intake. Very rough idle.	Hyd.	Hyd.	2500 to 6500	11-213-3	292H	292	292	244	244	.550	.550	110°
HYDRAULIC – Limited street use or bracket racing. 10.5:1+ compression, 3500+ stall or 4 speed. 4.10 or lower gears. Radical Idle.	Hyd.	Hyd.	3000 to 6800	11-214-4	305H	305	305	253	253	.575	.575	110°
XTREME ENERGY™ Hydraulic Flat Tappet Camshafts												
HYDRAULIC – Very strong torque, excellent mileage, smooth idle.	Hyd.	Hyd.	600 to 4800	11-230-3	XE250H	250	260	206	212	.470	.475	110°
HYDRAULIC – Strong torque thru low and mid-range, good idle.	Hyd.	Hyd.	1000 to 5200	11-234-3	XE256H	256	268	212	218	.480	.485	110°
HYDRAULIC – Strong torque. Excellent response, heavy towing in 454 with 4.10 gear.	Hyd.	Hyd.	1300 to 5600	11-238-3	XE262H	262	270	218	224	.504	.510	110°
HYDRAULIC – Good for street machines, slightly rough idle, stock converter will work but best with 1800+ stall.	Hyd.	Hyd.	1600 to 5800	11-242-3 11-242-20⁹⁴	XE268H	268	280	224	230	.515	.520	110°
HYDRAULIC – High performance street, very strong mid-range, with headers and 2200+ stall.	Hyd.	Hyd.	1800 to 6000	11-246-3 11-246-20⁹⁴	XE274H	274	286	230	236	.552	.555	110°
HYDRAULIC – Street/strip, 2800+ stall, rough idle, 9.5:1+ compression.	Hyd.	Hyd.	2300 to 6500	11-250-3 11-250-20⁹⁴	XE284H	284	296	240	246	.574	.578	110°
HYDRAULIC – Pro Street/bracket, good intake, headers, lower gears, 3200+ stall, 10.5:1+ compression.	Hyd.	Hyd.	2800 to 7000	11-254-4 11-254-20⁹⁴	XE294H	294	306	250	256	.588	.593	110°

TECH TIP

If you have a 1965-1966 Big Block Chevy engine, please notify your sales person before ordering.

² Requires machining on cylinder heads
⁷ Stock springs cannot be used

¹⁶ Truck engines have .400" taller block
¹⁷ Mark V & Mark VI heads must use kit w/ studs

¹⁸ 50-State legal for 1993 & earlier BB Chevrolet V8, 396-454c.i. C.A.R.B. E.O. #D-279-4

CHEVROLET 396-454 C.I. 8 CYL. 1967-1996

CAMSHAFTS GENERAL MOTORS

K-KIT	SK-KIT	CL-KIT	RP-KIT	LIFTERS	TIMING SET	ROCKER ARMS	PUSHRODS	VALVE SPRINGS	RETAINERS	VALVE LOCKS	VALVE SEALS
HIGH ENERGY™ Hydraulic Flat Tappet Camshafts											
K11-202-3	SK11-202-3 ⁷	CL11-202-3 ⁷	RP1411-16	812-16 858-16	3210	1411-16 ^{17,18} 1620-16 ^{17,18}	7854-16 ¹⁶	911-16 924-16 ²	744-16 741-16	603-16 ⁷⁵	504-16 505-16 ²
K11-203-3	SK11-203-3 ⁷	CL11-203-3 ⁷	RP1411-16	812-16 858-16	3210	1411-16 ^{17,18} 1620-16 ^{17,18}	7854-16 ¹⁶	911-16 924-16 ²	744-16 741-16	603-16 ⁷⁵	504-16 505-16 ²
K11-205-3	SK11-205-3 ⁷	CL11-205-3 ⁷	RP1411-16	812-16 858-16	3210	1411-16 ^{17,18} 1620-16 ^{17,18}	7854-16 ¹⁶	911-16 924-16 ²	744-16 741-16	603-16 ⁷⁵	504-16 505-16 ²
MAGNUM Hydraulic Flat Tappet Camshafts											
K11-207-3	SK11-207-3 ⁷	CL11-207-3 ⁷	RPM1411-16	812-16 858-16	2110 3110	1411-16 ^{17,18} 1620-16 ^{17,18}	7154-16 ¹⁶ 7954-16 ¹⁶	911-16 924-16 ²	748-16 741-16	612-16 ⁷⁵	504-16 505-16 ²
K11-208-3	SK11-208-3 ⁷	CL11-208-3 ⁷	RPM1411-16	812-16 858-16	2110 3110	1411-16 ^{17,18} 1620-16 ^{17,18}	7154-16 ¹⁶ 7954-16 ¹⁶	911-16 924-16 ²	748-16 741-16	612-16 ⁷⁵	504-16 505-16 ²
K11-318-4	SK11-318-4 ⁷	CL11-318-4 ⁷	RPM1411-16	812-16 858-16	2110 3110	1411-16 ^{17,18} 1620-16 ^{17,18}	7154-16 ¹⁶ 7954-16 ¹⁶	924-16 ² 26120-16	741-16 795-16	612-16 ⁷⁵ 616-16 ⁷⁵	505-16
K11-213-3	SK11-213-3 ⁷	CL11-213-3 ⁷	RPM1411-16	812-16 858-16	2110 3110	1411-16 ^{17,18} 1620-16 ^{17,18}	7154-16 ¹⁶ 7954-16 ¹⁶	924-16 ² 26120-16	741-16 795-16	612-16 ⁷⁵ 616-16 ⁷⁵	505-16
K11-214-4	SK11-214-4 ⁷	CL11-214-4 ⁷	RPM1411-16	812-16 858-16	2110 3110	1411-16 ^{17,18} 1620-16 ^{17,18}	7154-16 ¹⁶ 7954-16 ¹⁶	924-16 ² 26120-16	741-16 795-16	612-16 ⁷⁵ 616-16 ⁷⁵	505-16
XTREME ENERGY™ Hydraulic Flat Tappet Camshafts											
K11-230-3	SK11-230-3 ⁷	CL11-230-3 ⁷	RP1411-16	812-16 858-16	3210	1411-16 ^{17,18} 1620-16 ^{17,18}	7154-16 ¹⁶ 7954-16 ¹⁶	911-16 924-16 ²	744-16 741-16	603-16 ⁷⁵ 612-16 ⁷⁵	504-16 505-16 ²
K11-234-3	SK11-234-3 ⁷	CL11-234-3 ⁷	RP1411-16	812-16 858-16	3210	1411-16 ^{17,18} 1620-16 ^{17,18}	7154-16 ¹⁶ 7954-16 ¹⁶	911-16 924-16 ²	744-16 741-16	603-16 ⁷⁵ 612-16 ⁷⁵	504-16 505-16 ²
K11-238-3	SK11-238-3 ⁷	CL11-238-3 ⁷	RP1411-16	812-16 858-16	3210	1411-16 ^{17,18} 1620-16 ^{17,18}	7154-16 ¹⁶ 7954-16 ¹⁶	911-16 924-16 ²	744-16 741-16	603-16 ⁷⁵ 612-16 ⁷⁵	504-16 505-16 ²
K11-242-3	SK11-242-3 ⁷	CL11-242-3 ⁷	RP1411-16	812-16 858-16	2110 3110	1411-16 ^{17,18} 1620-16 ^{17,18}	7154-16 ¹⁶ 7954-16 ¹⁶	911-16 924-16 ²	748-16 741-16	612-16 ⁷⁵	504-16 505-16 ²
K11-246-3	SK11-246-3 ⁷	CL11-246-3 ⁷	RP1411-16	812-16 858-16	2110 3110	1411-16 ^{17,18} 1620-16 ^{17,18}	7154-16 ¹⁶ 7954-16 ¹⁶	924-16 ² 26120-16	741-16 795-16	612-16 ⁷⁵ 616-16 ⁷⁵	505-16
K11-250-3	SK11-250-3 ⁷	CL11-250-3 ⁷	RP1411-16	812-16 858-16	2110 3110	1411-16 ^{17,18} 1620-16 ^{17,18}	7154-16 ¹⁶ 7954-16 ¹⁶	924-16 ² 26120-16	741-16 795-16	612-16 ⁷⁵ 616-16 ⁷⁵	505-16
K11-254-4	SK11-254-4 ⁷	CL11-254-4 ⁷	RP1411-16	812-16 858-16	2110 3110	1411-16 ^{17,18} 1620-16 ^{17,18}	7154-16 ¹⁶ 7954-16 ¹⁶	924-16 ² 26120-16	741-16 795-16	612-16 ⁷⁵ 616-16 ⁷⁵	505-16

⁷⁵ Most aluminum heads come standard with 11/32" valve stems. Use appropriate valve locks, retainers, and seals.

⁹⁴ Nitrided version

RED NUMBERS DENOTE PREMIUM OPTION

CHEVROLET 396-454 C.I. 8 CYL. 1967-1996 (CONTINUED)

APPLICATIONS/CAMSHAFTS	VALVE SETTING		RPM OPERATING RANGE	CAM PART #	CAM GRIND #	DURATION				VALVE LIFT		LOBE SEP. ANGLE
	IN.	EX.				ADVERTISED IN.	EX.	@ .050" IN.	EX.	W/ 1.7 ROCKER IN.	EX.	
THUMPR™ Hydraulic Flat Tappet Camshafts												
HYDRAULIC – Thumpr™ – High performance street, stock converter ok, best with 2000+ converter and gears. Choppy/thumping idle.	Hyd.	Hyd.	1800 to 5600	11-600-4 11-600-20⁹⁴	279TH7	279	296	227	241	.498	.483	107°
HYDRAULIC – Mutha' Thumpr™ – High performance street/strip, needs 9:1 compression, 2500+ stall, intake, gears and headers, rough idle.	Hyd.	Hyd.	2000 to 5900	11-601-4 11-601-20⁹⁴	287TH7	287	304	235	249	.510	.495	107°
HYDRAULIC – Big Mutha' Thumpr™ – Street/strip, needs 9.5:1 compression, 2800+ stall, intake, gears and headers, very rough idle.	Hyd.	Hyd.	2300 to 6200	11-602-4 11-602-20⁹⁴	295TH7	295	312	243	257	.522	.507	107°
APPLICATIONS/CAMSHAFTS	VALVE SETTING		RPM OPERATING RANGE	CAM PART #	CAM GRIND #	DURATION				VALVE LIFT		LOBE SEP. ANGLE
IN.	EX.	ADVERTISED IN.				EX.	@ .050" IN.	EX.	W/ 1.7 ROCKER IN.	EX.		
XTREME 4X4™ Hydraulic Flat Tappet Camshafts												
HYDRAULIC – Good low end and mid-range torque and power, good idle.	Hyd.	Hyd.	1000 to 5000	11-231-3	X4 254H	254	262	210	218	.505	.505	111°
HYDRAULIC – Great mid-range power, largest cam for stock converter. Good for heavy towing with 4.10 gear.	Hyd.	Hyd.	1400 to 5400	11-235-3	X4 262H	262	270	218	226	.505	.515	111°
HYDRAULIC – Best with improved intake manifold, needs headers and 3.55-3.90 gears. 2000+ stall.	Hyd.	Hyd.	1600 to 5800	11-239-3	X4 270H	270	278	226	234	.544	.564	111°
HYDRAULIC – Good top end power, needs good intake, headers & gears. 9.5:1 compression & 2500+ stall.	Hyd.	Hyd.	2000 to 6200	11-243-4	X4 278H	278	288	234	244	.564	.570	111°
XTREME MARINE™ Hydraulic Flat Tappet Camshafts												
HYDRAULIC – Biggest for inboard/outboard, good for ski, economy and performance.	Hyd.	Hyd.	1000 to 5000	11-232-3	XM262H	262	268	218	224	.505	.515	112°
HYDRAULIC – Jet w/ A impeller, strong mid-range, good throttle response, noticeable idle.	Hyd.	Hyd.	1600 to 5800	11-236-4	XM270H	270	286	226	236	.544	.547	112°
HYDRAULIC – Jet w/ A impeller, needs improved intake, likes headers.	Hyd.	Hyd.	2000 to 6200	11-240-4 11-240-20⁹⁴	XM278H	278	292	234	244	.564	.566	112°
HYDRAULIC – Jet w/ A or B impeller, 9.5:1+ compression, needs headers, performance use.	Hyd.	Hyd.	2500 to 6500	11-244-4 11-244-20⁹⁴	XM288H	288	304	244	254	.570	.575	112°
HYDRAULIC – Jet w/ B impeller, 10:1+ compression, river drags, bracket racing.	Hyd.	Hyd.	3200 to 6800	11-252-4	XM298H	298	316	254	264	.575	.578	112°
MARINE Hydraulic Flat Tappet Camshafts												
HYDRAULIC – Good for jet boat or inboard/outboard drive for skiing, pleasure use, good economy.	Hyd.	Hyd.	1700 to 5700	11-306-4	268AH	268	276	222	226	.525	.525	110°
HYDRAULIC – Jet boat with A impeller. Skiing and pleasure use, good performance.	Hyd.	Hyd.	2400 to 6400	11-314-4	280AH	280	288	232	237	.547	.547	110°
HYDRAULIC – Jet boat with A or B impeller. Bracket racing or high performance use.	Hyd.	Hyd.	2500 to 6500	11-324-4	292AH	292	296	244	246	.568	.578	110°
HYDRAULIC – B impeller in jet boat. River drags and brackets. Use tunnel ram.	Hyd.	Hyd.	3800 to 6800	11-336-4	305AH	305	312	253	260	.575	.600	110°

² Requires machining on cylinder heads

⁷ Stock springs cannot be used

¹⁶ Truck engines have .400" taller block

¹⁷ Mark V & Mark VI heads must use kit w/ studs

¹⁸ 50-State legal for 1993 & earlier BB Chevrolet V8, 396-454c.i. C.A.R.B. E.O. #D-279-4

CHEVROLET 396-454 C.I. 8 CYL. 1967-1996 (CONTINUED)

CAMSHAFTS GENERAL MOTORS

K-KIT	GK-KIT	CL-KIT	RP-KIT	LIFTERS	TIMING SET	ROCKER ARMS	PUSHRODS	VALVE SPRINGS	RETAINERS	VALVE LOCKS	VALVE SEALS
THUMPR™ Hydraulic Flat Tappet Camshafts											
K11-600-4	GK11-600-4 ⁹³	CL11-600-4 ⁷	812-16 858-16	2110 3110	4110	1411-16 ^{17,18} 1620-16 ^{17,18}	7154-16 ¹⁶ 7954-16 ¹⁶	911-16 924-16 ²	748-16 741-16	612-16 ⁷⁵	504-16 505-16 ²
K11-601-4	GK11-601-4 ⁹³	CL11-601-4 ⁷	812-16 858-16	2110 3110	4110	1411-16 ^{17,18} 1620-16 ^{17,18}	7154-16 ¹⁶ 7954-16 ¹⁶	924-16 ² 26120-16	741-16 795-16	612-16 ⁷⁵ 616-16 ⁷⁵	505-16 ²
K11-602-4	GK11-602-4 ⁹³	CL11-602-4 ⁷	812-16 858-16	2110 3110	4110	1411-16 ^{17,18} 1620-16 ^{17,18}	7154-16 ¹⁶ 7954-16 ¹⁶	924-16 ² 26120-16	741-16 795-16	612-16 ⁷⁵ 616-16 ⁷⁵	505-16 ²
K-KIT	SK-KIT	CL-KIT	RP-KIT	LIFTERS	TIMING SET	ROCKER ARMS	PUSHRODS	VALVE SPRINGS	RETAINERS	VALVE LOCKS	VALVE SEALS
XTREME 4X4™ Hydraulic Flat Tappet Camshafts											
K11-231-3	SK11-231-3 ⁷	CL11-231-3 ⁷	RP1411-16	812-16 858-16	2110 3110	1411-16 ^{17,18} 1620-16 ^{17,18}	7854-16 ¹⁶ 7954-16 ¹⁶	911-16 924-16 ²	744-16 741-16	603-16 ⁷⁵ 612-16 ⁷⁵	504-16 505-16 ²
K11-235-3	SK11-235-3 ⁷	CL11-235-3 ⁷	RP1411-16	812-16 858-16	2110 3110	1411-16 ^{17,18} 1620-16 ^{17,18}	7854-16 ¹⁶ 7954-16 ¹⁶	911-16 924-16 ²	744-16 741-16	603-16 ⁷⁵ 612-16 ⁷⁵	504-16 505-16 ²
K11-239-3	SK11-239-3 ⁷	CL11-239-3 ⁷	RP1411-16	812-16 858-16	2110 3110	1411-16 ^{17,18} 1620-16 ^{17,18}	7854-16 ¹⁶ 7954-16 ¹⁶	924-16 ² 26120-16	741-16 795-16	612-16 ⁷⁵ 616-16 ⁷⁵	505-16 ²
K11-243-4	SK11-243-4 ⁷	CL11-243-4 ⁷	RP1411-16	812-16 858-16	2110 3110	1411-16 ^{17,18} 1620-16 ^{17,18}	7854-16 ¹⁶ 7954-16 ¹⁶	924-16 ² 26120-16	741-16 795-16	612-16 ⁷⁵ 616-16 ⁷⁵	505-16 ²
XTREME MARINE™ Hydraulic Flat Tappet Camshafts											
K11-232-3	SK11-232-3 ⁷	CL11-232-3 ⁷	RPM1411-16	812-16 858-16	2110 3110	1411-16 ^{17,18} 1620-16 ^{17,18}	7154-16 ¹⁶ 7954-16 ¹⁶	911-16 924-16 ²	748-16 741-16	612-16 ⁷⁵	504-16 505-16 ²
K11-236-4	SK11-236-4 ⁷	CL11-236-4 ⁷	RPM1411-16	812-16 858-16	2110 3110	1411-16 ^{17,18} 1620-16 ^{17,18}	7154-16 ¹⁶ 7954-16 ¹⁶	911-16 924-16 ²	748-16 741-16	612-16 ⁷⁵	504-16 505-16 ²
K11-240-4	SK11-240-4 ⁷	CL11-240-4 ⁷	RPM1411-16	812-16 858-16	2110 3110	1411-16 ^{17,18} 1620-16 ^{17,18}	7154-16 ¹⁶ 7954-16 ¹⁶	911-16 924-16 ²	748-16 741-16	612-16 ⁷⁵	504-16 505-16 ²
K11-244-4	SK11-244-4 ⁷	CL11-244-4 ⁷	RPM1411-16	812-16 858-16	2110 3110	1411-16 ^{17,18} 1620-16 ^{17,18}	7154-16 ¹⁶ 7954-16 ¹⁶	924-16 ² 26120-16	741-16 795-16	612-16 ⁷⁵ 616-16 ⁷⁵	505-16 ²
K11-252-4	SK11-252-4 ⁷	CL11-252-4 ⁷	RPM1411-16	812-16 858-16	2110 3110	1411-16 ^{17,18} 1620-16 ^{17,18}	7154-16 ¹⁶ 7954-16 ¹⁶	924-16 ² 26120-16	741-16 795-16	612-16 ⁷⁵ 616-16 ⁷⁵	505-16 ²
MARINE Hydraulic Flat Tappet Camshafts											
K11-306-4	SK11-306-4 ⁷	CL11-306-4 ⁷	RPM1411-16	812-16 858-16	2110 3110	1411-16 ^{17,18} 1620-16 ^{17,18}	7154-16 ¹⁶ 7954-16 ¹⁶	911-16 924-16 ²	748-16 741-16	612-16 ⁷⁵	504-16 505-16 ²
K11-314-4	SK11-314-4 ⁷	CL11-314-4 ⁷	RPM1411-16	812-16 858-16	2110 3110	1411-16 ^{17,18} 1620-16 ^{17,18}	7154-16 ¹⁶ 7954-16 ¹⁶	911-16 924-16 ²	748-16 741-16	612-16 ⁷⁵	504-16 505-16 ²
K11-324-4	SK11-324-4 ⁷	CL11-324-4 ⁷	RPM1411-16	812-16 858-16	2110 3110	1411-16 ^{17,18} 1620-16 ^{17,18}	7154-16 ¹⁶ 7954-16 ¹⁶	924-16 ² 26120-16	741-16 795-16	612-16 ⁷⁵ 616-16 ⁷⁵	505-16 ²
K11-336-4	SK11-336-4 ⁷	CL11-336-4 ⁷	RPM1411-16	812-16 858-16	2110 3110	1411-16 ^{17,18} 1620-16 ^{17,18}	7154-16 ¹⁶ 7954-16 ¹⁶	924-16 ² 930-16	741-16 1732-16	612-16 ⁷⁵	505-16 ²

⁷⁵ Most aluminum heads come standard with 11/32" valve stems. Use appropriate valve locks, retainers, and seals.

⁹³ GK-Kit contains cam, lifters & gear drive
⁹⁴ Nitrided version

RED NUMBERS DENOTE PREMIUM OPTION



CHEVROLET 396-454 C.I. 8 CYL. 1967-1996 (CONTINUED)

APPLICATIONS/CAMSHAFTS	VALVE SETTING		RPM OPERATING RANGE	CAM PART #	CAM GRIND #	DURATION				VALVE LIFT		LOBE SEP. ANGLE
	IN.	EX.				ADVERTISED IN.	EX.	@ .050" IN.	EX.	W/ 1.6 ROCKER IN.	EX.	
DUAL ENERGY™ Hydraulic Flat Tappet Camshafts												
HYDRAULIC – Good torque, good mileage. Excellent low end horsepower. Smooth idle.	Hyd.	Hyd.	1200 to 5500	11-206-3	255DEH	255	261	203	212	.460	.485	110°
HYDRAULIC – Very strong mid-range. Everyday performance for stock exhaust.	Hyd.	Hyd.	1500 to 5750	11-204-3	265DEH	265	272	211	221	.476	.507	110°
HYDRAULIC – High performance with superior high end power. Works with stock converter but best with 2000+ stall Choppy idle.	Hyd.	Hyd.	2000 to 6000	11-209-3	275DEH	275	283	219	229	.507	.531	110°
NOSTALGIA PLUS™ Hydraulic Flat Tappet Camshaft												
HYDRAULIC – Exhaust note of GM LS6 cam w/ hydraulic lifters and increased horsepower.	Hyd.	Hyd.	1800 to 6200	11-670-4	N+LS6	276	283	229	236	.530	.524	112°
NITROUS HP™ Hydraulic Flat Tappet Camshafts												
HYDRAULIC – High performance street, 100-150 HP nitrous kit or small blower.	Hyd.	Hyd.	1600 to 5900	11-556-4	NX262H	262	280	218	230	.505	.520	113°
HYDRAULIC – Street machines with 125+ hp nitrous kit, needs 2000+ stall, 3.73 gear, choppy idle.	Hyd.	Hyd.	2000 to 6200	11-560-4	NX268H	268	286	224	236	.515	.547	113°
HYDRAULIC – Pro Street applications w/ multi-stage nitrous kits, 671 blower or Vortec Supercharger and 3000+ stall.	Hyd.	Hyd.	2800 to 6800	11-568-4	NX284H	284	305	240	253	.575	.595	113°
HYDRAULIC – Race only, multi-stage kits w/ 871 blower, needs good heads, intake, gears and 3500+ stall.	Hyd.	Hyd.	2800 to 7000	11-572-4	NX294H	294	316	250	264	.588	.600	113°
COMPUTER CONTROLLED Hydraulic Flat Tappet Camshafts												
HYDRAULIC – For TBI 454. Stock computer will work in some applications.	Hyd.	Hyd.	800 to 4800	11-206-3	255DEH	255	261	203	212	.460	.485	110°
HYDRAULIC – For TBI with stock converter and exhaust upgrade.	Hyd.	Hyd.	1000 to 5200	11-302-4	260AH	260	268	212	218	.503	.503	112°
BLOWER & TURBO Hydraulic Flat Tappet Camshafts												
HYDRAULIC – Good mid-range turbo grind. Short exhaust produces more velocity, helps increase boost.	Hyd.	Hyd.	1800 to 5800	11-400-4	276TH	276	268	226	218	.525	.514	115°
HYDRAULIC – Strong blower cam. Works well with small blowers, centrifugal or roots.	Hyd.	Hyd.	2500 to 6500	11-404-4	280AH	280	288	232	237	.547	.547	114°
XTREME ENERGY™ 4 & 7 SWAP FIRING ORDER Hydraulic Flat Tappet Camshafts												
18736542 Firing Order												
HYDRAULIC – High performance street, strong mid-range, needs headers and 2500+ stall.	Hyd.	Hyd.	1800 to 6000	11-650-47	XE274H-10	274	286	230	236	.552	.555	110°
HYDRAULIC – Street/strip, 2800+ stall, rough idle, 9.5:1+ compression.	Hyd.	Hyd.	2300 to 6500	11-651-47	XE284H-10	284	296	240	246	.574	.578	110°
HYDRAULIC – Pro Street/bracket, needs good intake, headers, gear and 3200+ stall.	Hyd.	Hyd.	2800 to 7000	11-652-47	XE294H-10	294	306	250	256	.588	.593	110°
OVAL TRACK Hydraulic Flat Tappet Camshafts												
HYDRAULIC – Good for hobby stock with 427-454 on 1/4 to 3/8 track.	Hyd.	Hyd.	2600 to 6500	11-314-4	280AH-10	280	288	232	237	.547	.547	110°
HYDRAULIC – Good for hobby stock 454 where hydraulic lifters must be used.	Hyd.	Hyd.	2500 to 6500	11-213-3	292H-10	292	292	244	244	.550	.550	110°

² Requires machining on cylinder heads

⁷ Stock springs cannot be used

¹⁶ Truck engines have .400" taller block

¹⁷ Mark V & Mark VI heads must use kit w/ studs

¹⁸ 50-State legal for 1993 & earlier BB Chevrolet V8, 396-454c.i. C.A.R.B. E.O. #D-279-4

CHEVROLET 396-454 C.I. 8 CYL. 1967-1996 (CONTINUED)

CAMSHAFTS GENERAL MOTORS

K-KIT	SK-KIT	CL-KIT	RP-KIT	LIFTERS	TIMING SET	ROCKER ARMS	PUSHRODS	VALVE SPRINGS	RETAINERS	VALVE LOCKS	VALVE SEALS
DUAL ENERGY™ Hydraulic Flat Tappet Camshafts											
K11-206-3	SK11-206-3 ⁷	CL11-206-3 ⁷	RP1411-16	812-16 858-16	3210 2110	1411-16 ^{17,18} 1620-16 ^{17,18}	7854-16 ¹⁶ 7954-16 ¹⁶	911-16 924-16 ²	744-16 741-16	603-16 ⁷⁵ 612-16 ⁷⁵	504-16 505-16 ²
K11-204-3	SK11-204-3 ⁷	CL11-204-3 ⁷	RP1411-16	812-16 858-16	3210 2110	1411-16 ^{17,18} 1620-16 ^{17,18}	7854-16 ¹⁶ 7954-16 ¹⁶	911-16 924-16 ²	744-16 741-16	603-16 ⁷⁵ 612-16 ⁷⁵	504-16 505-16 ²
K11-209-3	SK11-209-3 ⁷	CL11-209-3 ⁷	RP1411-16	812-16 858-16	3210 2110	1411-16 ^{17,18} 1620-16 ^{17,18}	7854-16 ¹⁶ 7954-16 ¹⁶	911-16 924-16 ²	744-16 741-16	603-16 ⁷⁵ 612-16 ⁷⁵	504-16 505-16 ²
NOSTALGIA PLUS™ Hydraulic Flat Tappet Camshaft											
K11-670-4	SK11-670-4 ⁷	CL11-670-4 ⁷	RP1411-16	812-16 858-16	2110 3110	1411-16 ^{17,18} 1620-16 ^{17,18}	7854-16 ¹⁶ 7954-16 ¹⁶	924-16 ² 26120-16	741-16 795-16	612-16 ⁷⁵ 616-16 ⁷⁵	505-16 ²
NITROUS HP™ Hydraulic Flat Tappet Camshafts											
K11-556-4	SK11-556-4 ⁷	CL11-556-4 ⁷	RP1411-16	812-16 858-16	2110 3110	1411-16 ^{17,18} 1620-16 ^{17,18}	7854-16 ¹⁶ 7954-16 ¹⁶	924-16 ² 26120-16	741-16 795-16	612-16 ⁷⁵ 616-16 ⁷⁵	505-16 ²
K11-560-4	SK11-560-4 ⁷	CL11-560-4 ⁷	RP1411-16	812-16 858-16	2110 3110	1411-16 ^{17,18} 1620-16 ^{17,18}	7854-16 ¹⁶ 7954-16 ¹⁶	924-16 ² 26120-16	741-16 795-16	612-16 ⁷⁵ 616-16 ⁷⁵	505-16 ²
K11-568-4	SK11-568-4 ⁷	CL11-568-4 ⁷	RP1411-16	812-16 858-16	2110 3110	1411-16 ^{17,18} 1620-16 ^{17,18}	7854-16 ¹⁶ 7954-16 ¹⁶	924-16 ² 930-16 ²	741-16 1732-16	612-16 ⁷⁵	505-16 ²
K11-572-4	SK11-572-4 ⁷	CL11-572-4 ⁷	RP1411-16	812-16 858-16	2110 3110	1411-16 ^{17,18} 1620-16 ^{17,18}	7854-16 ¹⁶ 7954-16 ¹⁶	924-16 ² 930-16 ²	741-16 1732-16	612-16 ⁷⁵	505-16 ²
COMPUTER CONTROLLED Hydraulic Flat Tappet Camshafts											
K11-206-3	SK11-206-3 ⁷	CL11-206-3 ⁷	RPM1411-16	812-16	3210	1411-16 ^{17,18}	7154-16 ¹⁶	911-16	744-16	603-16 ⁷⁵	504-16
K11-302-4	SK11-302-4 ⁷	CL11-302-4 ⁷	RPM1411-16	812-16 858-16	3210 2110	1411-16 ^{17,18} 1620-16 ^{17,18}	7154-16 ¹⁶ 7954-16 ¹⁶	911-16 924-16 ²	744-16 741-16	603-16 ⁷⁵ 612-16 ⁷⁵	504-16 505-16 ²
BLOWER & TURBO Hydraulic Flat Tappet Camshafts											
K11-400-4	SK11-400-4 ⁷	CL11-400-4 ⁷	RPM1411-16	812-16 858-16	3210 2110	1411-16 ^{17,18} 1620-16 ^{17,18}	7154-16 ¹⁶ 7954-16 ¹⁶	911-16 924-16 ²	744-16 741-16	603-16 ⁷⁵ 612-16 ⁷⁵	504-16 505-16 ²
K11-404-4	SK11-404-4 ⁷	CL11-404-4 ⁷	RPM1411-16	812-16 858-16	3210 2110	1411-16 ^{17,18} 1620-16 ^{17,18}	7154-16 ¹⁶ 7954-16 ¹⁶	911-16 924-16 ²	744-16 741-16	603-16 ⁷⁵ 612-16 ⁷⁵	504-16 505-16 ²
LIFTERS	TIMING SET	ROCKER ARMS	PUSHRODS	VALVE SPRINGS	RETAINERS	VALVE LOCKS	VALVE SEALS	LASH CAPS	DIST. GEAR	STUD GIRDLES	
XTREME ENERGY™ 4 & 7 SWAP FIRING ORDER Hydraulic Flat Tappet Camshafts											
812-16 858-16	2110 7110	1620-16 ^{17,18} 1820-16 ^{17,18}	7154-16 ¹⁶ 7954-16 ¹⁶	924-16 ² 26120-16	741-16 795-16	732-16 794-16	612-16 ⁷⁵ 616-16 ⁷⁵	505-16 ²	622-16	12200 12140	4021
812-16 858-16	2110 7110	1620-16 ^{17,18} 1820-16 ^{17,18}	7154-16 ¹⁶ 7954-16 ¹⁶	924-16 ² 26120-16	741-16 795-16	732-16 794-16	612-16 ⁷⁵ 616-16 ⁷⁵	505-16 ²	622-16	12200 12140	4021
812-16 858-16	2110 7110	1620-16 ^{17,18} 1820-16 ^{17,18}	7154-16 ¹⁶ 7954-16 ¹⁶	924-16 ² 26120-16	741-16 1732-16	732-16	612-16 ⁷⁵	505-16 ²	622-16	12200 12140	4021
OVAL TRACK Hydraulic Flat Tappet Camshafts											
858-16	3110 3110KT	1620-16 ^{17,18} 1820-16 ^{17,18}	7954-16 ¹⁶	911-16 924-16 ²	741-16	732-16	612-16 ⁷⁵	505-16 ²	622-16	12200 12140	4021
858-16	3110 3110KT	1620-16 ^{17,18} 1820-16 ^{17,18}	7954-16 ¹⁶	924-16 ² 26120-16	741-16 795-16	732-16 794-16	612-16 ⁷⁵ 616-16 ⁷⁵	505-16 ²	622-16	12200 12140	4021

⁷⁵ Most aluminum heads come standard with 11/32" valve stems. Use appropriate valve locks, retainers, and seals.



CHEVROLET 396-454 C.I. 8 CYL. 1967-1996 (CONTINUED)

APPLICATIONS/CAMSHAFTS	VALVE SETTING		RPM OPERATING RANGE	CAM PART #	CAM GRIND #	DURATION				VALVE LIFT		LOBE SEP. ANGLE
	IN.	EX.				ADVERTISED IN.	EX.	@ .050" IN.	EX.	W/ 1.7 ROCKER IN.	EX.	
MAGNUM Retro-Fit Hydraulic Roller Camshafts												
HYDRAULIC ROLLER – Most bottom end with stock engine. RV/towing use. Works with stock exhaust and intake, 3.73+ gear.	Hyd.	Hyd.	1200 to 4500	11-410-8^{10,46}	260HR	260	260	206	206	.510	.510	110°
HYDRAULIC ROLLER – Daily driven street machines. Works with stock converters. Likes headers. 396c.i. needs 3.55-3.73+ gear. Slightly rough idle.	Hyd.	Hyd.	1800 to 5000	11-420-8^{10,46}	270HR	270	270	215	215	.566	.566	110°
HYDRAULIC ROLLER – Great for street machines. Use headers, 9.5:1+ compression and 2000+ stall. Lower gears in all applications. Rough idle.	Hyd.	Hyd.	2000 to 5500	11-430-8^{10,46}	280HR	280	280	224	224	.566	.566	110°
HYDRAULIC ROLLER – For hot street machines. 2500+ stall, 9.5:1+ compression. Best with headers and aluminum intake. Rough idle.	Hyd.	Hyd.	2500 to 6200	11-450-8^{10,46}	290HR	290	290	232	232	.578	.578	110°
HYDRAULIC ROLLER – Street/strip. 10:1+ compression, 3000+ stall, 4.10+ gears, aftermarket intake and headers. Very rough idle.	Hyd.	Hyd.	3000 to 6500	11-460-8^{10,46}	304HR	304	304	244	244	.612	.612	110°
HYDRAULIC ROLLER – Street/bracket racing. 10.5:1+ compression, 3500+ stall, 4.10 or lower gears. Headers, good intake and heads. Radical idle.	Hyd.	Hyd.	3500 to 6500	11-470-8^{10,46}	314HR	314	314	252	252	.612	.612	110°
THUMPR™ Retro-Fit Hydraulic Roller Camshafts												
HYDRAULIC ROLLER – Thumpr™ – High performance street, stock converter ok, best with 2000+ converter and gears, choppy/thumping idle.	Hyd.	Hyd.	1700 to 5500	11-600-8^{10,46}	283THR7	283	303	227	241	.547	.530	107°
HYDRAULIC ROLLER – Mutha' Thumpr™ – High performance street/strip, needs 9:1 compression, 2500+ stall, intake, gears and headers, rough idle.	Hyd.	Hyd.	2000 to 5800	11-601-8^{10,46}	291THR7	291	311	235	249	.558	.542	107°
HYDRAULIC ROLLER – Big Mutha' Thumpr™ – Street/strip, needs 9.5:1 compression, 2800+ stall, intake, gears and headers, very rough idle.	Hyd.	Hyd.	2300 to 6100	11-602-8^{10,46}	299THR7	299	319	243	257	.570	.554	107°
XTREME ENERGY™ Retro-Fit Hydraulic Roller Camshafts												
HYDRAULIC ROLLER – Excellent mileage, smooth idle, strong torque through RPM range.	Hyd.	Hyd.	600 to 4600	11-407-8^{10,46}	XR252HR	252	258	200	206	.510	.510	110°
HYDRAULIC ROLLER – Strong torque, good mileage, RV and towing.	Hyd.	Hyd.	1000 to 5000	11-408-8^{10,46}	XR258HR	258	264	206	212	.510	.510	110°
HYDRAULIC ROLLER – Daily driver to mild performance, strong torque, good mileage.	Hyd.	Hyd.	1200 to 5200	11-413-8^{10,46}	XR264HR	264	270	212	218	.510	.510	110°
HYDRAULIC ROLLER – Performance application, great mid-range torque, likes headers.	Hyd.	Hyd.	1600 to 5400	11-422-8^{10,46}	XR270HR	270	276	218	224	.510	.510	110°
HYDRAULIC ROLLER – Great for street machines, needs intake, headers, 2000+ stall and gears.	Hyd.	Hyd.	1900 to 5600	11-423-8^{10,46}	XR276HR	276	282	224	230	.510	.510	110°
HYDRAULIC ROLLER – High performance for street cars with 2200+ stall, 9:1+ compression, headers.	Hyd.	Hyd.	2200 to 5800	11-432-8^{10,46}	XR282HR	282	288	230	236	.510	.510	110°
HYDRAULIC ROLLER – Street/strip applications, works well in large ci street machine engines w/ 2500+ stall.	Hyd.	Hyd.	2500 to 6000	11-433-8^{10,46}	XR288HR	288	294	236	242	.521	.540	110°

² Requires machining on cylinder heads

⁷ Stock springs cannot be used

¹⁰ Requires thrust button & wear plate

¹⁶ Truck engines have .400" taller block

¹⁷ Mark V & Mark VI heads must use kit w/ studs

¹⁸ 50-State legal for 1993 & earlier BB Chevrolet V8, 396-454c.i. C.A.R.B. E.O. #D-279-4

CHEVROLET 396-454 C.I. 8 CYL. 1967-1996 (CONTINUED)

K-KIT	SK-KIT	CL-KIT	LIFTERS	DIST. GEAR	TIMING SET	ROCKER ARMS	PUSHRODS	VALVE SPRINGS	RETAINERS	VALVE LOCKS	VALVE SEALS
MAGNUM Retro-Fit Hydraulic Roller Camshafts											
K11-410-8	SK11-410-8 ^{7,10}	CL11-410-8 ^{7,10}	854-16 15854-16	412M	2110 3110	1411-16 ^{17,18} 1620-16 ^{17,18}	7815-16 ¹⁶ 7663-16 ¹⁶	911-16 924-16 ²	748-16 741-16	612-16 ⁷⁵	504-16 505-16 ²
K11-420-8	SK11-420-8 ^{7,10}	CL11-420-8 ^{7,10}	854-16 15854-16	412M	2110 3110	1411-16 ^{17,18} 1620-16 ^{17,18}	7815-16 ¹⁶ 7663-16 ¹⁶	911-16 924-16 ²	748-16 741-16	612-16 ⁷⁵	504-16 505-16 ²
K11-430-8	SK11-430-8 ^{7,10}	CL11-430-8 ^{7,10}	854-16 15854-16	412M	2110 3110	1411-16 ^{17,18} 1620-16 ^{17,18}	7815-16 ¹⁶ 7663-16 ¹⁶	911-16 924-16 ²	748-16 741-16	612-16 ⁷⁵	504-16 505-16 ²
K11-450-8	SK11-450-8 ^{7,10}	CL11-450-8 ^{7,10}	854-16 15854-16	412M	2110 3110	1411-16 ^{17,18} 1620-16 ^{17,18}	7815-16 ¹⁶ 7663-16 ¹⁶	924-16 ² 26120-16	741-16 795-16	612-16 ⁷⁵ 616-16 ⁷⁵	505-16 ²
K11-460-8	SK11-460-8 ^{7,10}	CL11-460-8 ^{7,10}	854-16 15854-16	412M	2110 3110	1411-16 ^{17,18} 1620-16 ^{17,18}	7815-16 ¹⁶ 7663-16 ¹⁶	924-16 ² 26120-16	741-16 795-16	612-16 ⁷⁵ 616-16 ⁷⁵	505-16 ²
K11-470-8	SK11-470-8 ^{7,10}	CL11-470-8 ^{7,10}	854-16 15854-16	412M	2110 3110	1411-16 ^{17,18} 1620-16 ^{17,18}	7815-16 ¹⁶ 7663-16 ¹⁶	924-16 ² 26120-16	741-16 795-16	612-16 ⁷⁵ 616-16 ⁷⁵	505-16 ²
K-KIT	GK-KIT	CL-KIT	LIFTERS	TIMING SET	GEAR DRIVE	ROCKER ARMS	PUSHRODS	VALVE SPRINGS	RETAINERS	VALVE LOCKS	VALVE SEALS
THUMPR™ Retro-Fit Hydraulic Roller Camshafts											
K11-600-8	GK11-600-8 ^{7,93}	CL11-600-8 ⁷	854-16 15854-16	2110 3110	4110	1411-16 ^{17,18} 1620-16 ^{17,18}	7663-16 7998-16	924-16 ² 26120-16	741-16 795-16	612-16 ⁷⁵ 616-16 ⁷⁵	505-16 ²
K11-601-8	GK11-601-8 ^{7,93}	CL11-601-8 ⁷	854-16 15854-16	2111 3110	4110	1411-16 ^{17,18} 1620-16 ^{17,18}	7663-16 7998-16	924-16 ² 26120-16	741-16 795-16	612-16 ⁷⁵ 616-16 ⁷⁵	505-16 ²
K11-602-8	GK11-602-8 ^{7,93}	CL11-602-8 ⁷	854-16 15854-16	2112 3110	4110	1411-16 ^{17,18} 1620-16 ^{17,18}	7663-16 7998-16	924-16 ² 26120-16	741-16 795-16	612-16 ⁷⁵ 616-16 ⁷⁵	505-16 ²
K-KIT	SK-KIT	CL-KIT	LIFTERS	DIST. GEAR	TIMING SET	ROCKER ARMS	PUSHRODS	VALVE SPRINGS	RETAINERS	VALVE LOCKS	VALVE SEALS
XTREME ENERGY™ Retro-Fit Hydraulic Roller Camshafts											
K11-407-8	SK11-407-8 ^{7,10}	CL11-407-8 ^{7,10}	854-16 15854-16	412M	2110 3110	1411-16 ^{17,18} 1620-16 ^{17,18}	7815-16 ¹⁶ 7663-16 ¹⁶	911-16 924-16 ²	748-16 741-16	612-16 ⁷⁵	504-16 505-16 ²
K11-408-8	SK11-408-8 ^{7,10}	CL11-408-8 ^{7,10}	854-16 15854-16	412M	2110 3110	1411-16 ^{17,18} 1620-16 ^{17,18}	7815-16 ¹⁶ 7663-16 ¹⁶	911-16 924-16 ²	748-16 741-16	612-16 ⁷⁵	504-16 505-16 ²
K11-413-8	SK11-413-8 ^{7,10}	CL11-413-8 ^{7,10}	854-16 15854-16	412M	2110 3110	1411-16 ^{17,18} 1620-16 ^{17,18}	7815-16 ¹⁶ 7663-16 ¹⁶	911-16 924-16 ²	748-16 741-16	612-16 ⁷⁵	504-16 505-16 ²
K11-422-8	SK11-422-8 ^{7,10}	CL11-422-8 ^{7,10}	854-16 15854-16	412M	2110 3110	1411-16 ^{17,18} 1620-16 ^{17,18}	7815-16 ¹⁶ 7663-16 ¹⁶	911-16 924-16 ²	748-16 741-16	612-16 ⁷⁵	504-16 505-16 ²
K11-423-8	SK11-423-8 ^{7,10}	CL11-423-8 ^{7,10}	854-16 15854-16	412M	2110 3110	1411-16 ^{17,18} 1620-16 ^{17,18}	7815-16 ¹⁶ 7663-16 ¹⁶	911-16 924-16 ²	748-16 741-16	612-16 ⁷⁵	504-16 505-16 ²
K11-432-8	SK11-432-8 ^{7,10}	CL11-432-8 ^{7,10}	854-16 15854-16	412M	2110 3110	1411-16 ^{17,18} 1620-16 ^{17,18}	7815-16 ¹⁶ 7663-16 ¹⁶	911-16 924-16 ²	748-16 741-16	612-16 ⁷⁵	504-16 505-16 ²
K11-433-8	SK11-433-8 ^{7,10}	CL11-433-8 ^{7,10}	854-16 15854-16	412M	2110 3110	1411-16 ^{17,18} 1620-16 ^{17,18}	7815-16 ¹⁶ 7663-16 ¹⁶	924-16 ² 26120-16	741-16 795-16	612-16 ⁷⁵ 616-16 ⁷⁵	505-16 ²

⁴⁶ Must use bronze tip fuel pump pushrod when using high pressure or high volume pump

⁷⁵ Most aluminum heads come standard with 11/32" valve stems. Use appropriate valve locks, retainers, and seals.

⁹³ GK-Kit contains cam, lifters & gear drive



CHEVROLET 396-454 C.I. 8 CYL. 1967-1996 (CONTINUED)

APPLICATIONS/CAMSHAFTS	VALVE SETTING		RPM OPERATING RANGE	CAM PART #	CAM GRIND #	DURATION				VALVE LIFT		LOBE SEP. ANGLE
	IN.	EX.				IN.	EX.	IN.	EX.	IN.	EX.	
XTREME ENERGY™ Retro-Fit Hydraulic Roller Camshafts (CONTINUED)												
HYDRAULIC ROLLER – Street/strip applications, 10:1+ compression, 3000+ stall, intake, headers, gears.	Hyd.	Hyd.	2800 to 6100	11-443-8 ^{10,46}	XR294HR	294	300	242	248	.540	.560	110°
HYDRAULIC ROLLER – Pro Street/bracket racing, 10:1+ compression, 3500+ stall, good intake, headers.	Hyd.	Hyd.	3200 to 6200	11-444-8 ^{10,46}	XR300HR	300	306	248	254	.560	.580	110°
XTREME MARINE™ Retro-Fit Hydraulic Roller Camshafts												
HYDRAULIC ROLLER – Good for inboard/outboard pleasure boats, has good idle.	Hyd.	Hyd.	1600 to 5400	11-445-8 ^{10,46}	XM270HR	270	276	218	224	.510	.510	112°
HYDRAULIC ROLLER – Good for jet boat with A impeller. Great for pleasure or mild performance use.	Hyd.	Hyd.	2200 to 5800	11-451-8 ^{10,46}	XM284HR	284	290	230	236	.547	.547	112°
HYDRAULIC ROLLER – Good for jet boat with A or B impeller in bracket racing or performance use.	Hyd.	Hyd.	2800 to 6200	11-456-8 ^{10,46}	XM296HR	296	302	242	248	.566	.566	112°
HYDRAULIC ROLLER – Good in jet boat w/ B impeller, 10:1+ compression, running river drags or bracket racing.	Hyd.	Hyd.	3500 to 6500	11-461-8 ^{10,46}	XM308HR	308	314	254	260	.575	.575	112°
NITROUS HP™ Retro-Fit Hydraulic Roller Camshafts												
HYDRAULIC ROLLER – Street machines with 125+ hp nitrous kit, 2200+ stall and lower gears.	Hyd.	Hyd.	1800 to 5800	11-409-8 ^{10,46}	NX273HR	273	292	224	236	.537	.547	113°
HYDRAULIC ROLLER – High performance street w/ 150+ hp nitrous kit or small supercharger, 2400+ stall & lower gears.	Hyd.	Hyd.	2000 to 6200	11-411-8 ^{10,46}	NX279HR	279	294	230	242	.537	.541	113°
HYDRAULIC ROLLER – 200+ hp nitrous system, 671 or larger supercharger, 9.5:1+ compression, 2800+ stall.	Hyd.	Hyd.	2400 to 6500	11-414-8 ^{10,46}	NX298HR	298	310	242	254	.566	.575	113°
COMPUTER CONTROLLED Retro-Fit Hydraulic Roller Camshaft												
HYDRAULIC ROLLER – For throttle body injection 454.	Hyd.	Hyd.	1000 to 5000	11-412-8 ^{10,46}	266HR-12	266	276	210	220	.485	.485	112°
4-PATTERN Retro-Fit Hydraulic Roller Camshafts (Larger cam lobes for outboard cylinders)												
Larger Cam Lobes For Outboard Cylinders												
HYDRAULIC ROLLER – Best choice for street 396-454c.i. engines with good cylinder heads. Very wide power range. 2600+ stall.	Hyd.	Hyd.	2400-6700	11-615-44	281QI09	283 OB	295 OB	231 OB	241 OB	.661 OB	.648 OB	109.5 OB
						281 IB	293 IB	229 IB	239 IB	.658 IB	.644 IB	108.5 IB
HYDRAULIC ROLLER – Great in street strip 454-502c.i. engines with good heads & 9.5:1+ compression; 3000+ stall or manual transmissions.	Hyd.	Hyd.	2900-7200	11-616-44	293QI010	295 OB	307 OB	243 OB	253 OB	.678 OB	.661 OB	110.5 OB
						293 IB	305 IB	241 IB	251 IB	.677 IB	.661 IB	109.5 IB
HYDRAULIC ROLLER – Recommended in highly modified street/strip or bracket race engines and also works well in 572+ c.i. applications.	Hyd.	Hyd.	3200-7500	11-617-44	305QI010	307 OB	319 OB	255 OB	265 OB	.678 OB	.661 OB	110.5 OB
						305 IB	317 IB	253 IB	263 IB	.678 IB	.661 IB	109.5 IB
DRAG RACE Hydraulic Roller Camshafts												
HYDRAULIC ROLLER – Strong bracket cam for 396c.i. Needs 10.5:1+ compression & 4000 stall.	Hyd.	Hyd.	3800-6800	11-870-11	313QNHR-8	313	325	260	270	.676	.659	108°
HYDRAULIC ROLLER – Best in 454c.i. engines with good cylinder heads. Needs 11:1 compression and 4500+ stall.	Hyd.	Hyd.	4000-7000	11-871-11	321QNHR-10	321	329	267	275	.680	.680	110°
HYDRAULIC ROLLER – Serious bracket race cam for 454c.i. engines. Needs good cylinder heads and 11.5:1 compression.	Hyd.	Hyd.	4500-7200	11-872-11	325QNHR-12	325	337	271	283	.680	.680	112°

² Requires machining on cylinder heads

⁷ Stock springs cannot be used

¹⁰ Requires thrust button & wear plate

¹² 11/32 Valves Required

¹⁶ Truck engines have .400" taller block

¹⁷ Mark V & Mark VI heads must use kit w/ studs

¹⁸ 50-State legal for 1993 & earlier BB Chevrolet V8, 396-454c.i. C.A.R.B. E.O. #D-279-4

CHEVROLET 396-454 C.I. 8 CYL. 1967-1996 (CONTINUED)

CAMSHAFTS GENERAL MOTORS

K-KIT	SK-KIT	CL-KIT	LIFTERS	DIST. GEAR	TIMING SET	ROCKER ARMS	PUSHRODS	VALVE SPRINGS	RETAINERS	VALVE LOCKS	VALVE SEALS
XTREME ENERGY™ Retro-Fit Hydraulic Roller Camshafts (CONTINUED)											
K11-443-8	SK11-443-8 ^{7,10}	CL11-443-8 ^{7,10}	854-16 15854-16	412M	2110 3110	1411-16 ^{17,18} 1620-16 ^{17,18}	7815-16 ¹⁶ 7663-16 ¹⁶	924-16 ² 26120-16	741-16 795-16	612-16 ⁷⁵ 616-16 ⁷⁵	505-16 ²
K11-444-8	SK11-444-8 ^{7,10}	CL11-444-8 ^{7,10}	854-16 15854-16	412M	2110 3110	1411-16 ^{17,18} 1620-16 ^{17,18}	7815-16 ¹⁶ 7663-16 ¹⁶	924-16 ² 26120-16	741-16 795-16	612-16 ⁷⁵ 616-16 ⁷⁵	505-16 ²
XTREME MARINE™ Retro-Fit Hydraulic Roller Camshafts											
K11-445-8	SK11-445-8 ^{7,10}	CL11-445-8 ^{7,10}	854-16 15854-16	412M	2110 7110	1411-16 ^{17,18} 1620-16 ^{17,18}	7815-16 ¹⁶ 7663-16 ¹⁶	911-16 924-16 ²	748-16 741-16	612-16 ⁷⁵	504-16 505-16 ²
K11-451-8	SK11-451-8 ^{7,10}	CL11-451-8 ^{7,10}	854-16 15854-16	412M	2110 7110	1411-16 ^{17,18} 1620-16 ^{17,18}	7815-16 ¹⁶ 7663-16 ¹⁶	924-16 ² 26120-16	741-16 795-16	612-16 ⁷⁵ 616-16 ⁷⁵	505-16 ²
K11-456-8	SK11-456-8 ^{7,10}	CL11-456-8 ^{7,10}	854-16 15854-16	412M	2110 7110	1411-16 ^{17,18} 1620-16 ^{17,18}	7815-16 ¹⁶ 7663-16 ¹⁶	924-16 ² 26120-16	741-16 795-16	612-16 ⁷⁵ 616-16 ⁷⁵	505-16 ²
K11-461-8	SK11-461-8 ^{7,10}	CL11-461-8 ^{7,10}	854-16 15854-16	412M	2110 7110	1411-16 ^{17,18} 1620-16 ^{17,18}	7815-16 ¹⁶ 7663-16 ¹⁶	924-16 ² 26120-16	741-16 795-16	612-16 ⁷⁵ 616-16 ⁷⁵	505-16 ²
NITROUS HP™ Retro-Fit Hydraulic Roller Camshafts											
K11-409-8	SK11-409-8 ^{7,10}	CL11-409-8 ^{7,10}	854-16 15854-16	412M	2110 7110	1411-16 ^{17,18} 1620-16 ^{17,18}	7815-16 ¹⁶ 7663-16 ¹⁶	924-16 ² 26120-16	741-16 795-16	612-16 ⁷⁵ 616-16 ⁷⁵	505-16 ²
K11-411-8	SK11-411-8 ^{7,10}	CL11-411-8 ^{7,10}	854-16 15854-16	412M	2110 7110	1411-16 ^{17,18} 1620-16 ^{17,18}	7815-16 ¹⁶ 7663-16 ¹⁶	924-16 ² 26120-16	741-16 795-16	612-16 ⁷⁵ 616-16 ⁷⁵	505-16 ²
K11-414-8	SK11-414-8 ^{7,10}	CL11-414-8 ^{7,10}	854-16 15854-16	412M	2110 7110	1411-16 ^{17,18} 1620-16 ^{17,18}	7815-16 ¹⁶ 7663-16 ¹⁶	924-16 ² 26120-16	741-16 795-16	612-16 ⁷⁵ 616-16 ⁷⁵	505-16 ²
COMPUTER CONTROLLED Retro-Fit Hydraulic Roller Camshaft											
K11-412-8	SK11-412-8 ^{7,10}	CL11-412-8 ^{7,10}	854-16 15854-16	412M	2110 7110	1411-16 ^{17,18} 1620-16 ^{17,18}	7815-16 ¹⁶ 7663-16 ¹⁶	911-16 924-16 ²	748-16 741-16	612-16 ⁷⁵	504-16 505-16 ²
4-PATTERN Retro-Fit Hydraulic Roller Camshafts (Larger cam lobes for outboard cylinders)											
N/A	N/A	N/A	15854-16	412M	3110 7110	19021-16 1620-16	N/A	953-16 933-16	1732-16 732-16	612-16 ⁷⁵ 611-16 ¹²	515-16 ⁷⁵ 529-16 ¹²
N/A	N/A	N/A	15854-16	412M	3110 7110	19021-16 1620-16	N/A	953-16 933-16	1732-16 732-16	612-16 ⁷⁵ 611-16 ¹²	515-16 ⁷⁵ 529-16 ¹²
N/A	N/A	N/A	15854-16	412M	3110 7110	19021-16 1620-16	N/A	953-16 933-16	1732-16 732-16	612-16 ⁷⁵ 611-16 ¹²	515-16 ⁷⁵ 529-16 ¹²
DRAG RACE Hydraulic Roller Camshafts											
N/A	N/A	N/A	15854-16	412M	3110 7110	19021-16 1620-16	N/A	933-16 932-16	1732-16	612-16 ⁷⁵ 611-16 ¹²	515-16 ⁷⁵ 529-16 ¹²
N/A	N/A	N/A	15854-16	412M	3110 7110	19021-16 1620-16	N/A	933-16 932-16	1732-16	612-16 ⁷⁵ 611-16 ¹²	515-16 ⁷⁵ 529-16 ¹²
N/A	N/A	N/A	15854-16	412M	3110 7110	19021-16 1620-16	N/A	933-16 932-16	1732-16	612-16 ⁷⁵ 611-16 ¹²	515-16 ⁷⁵ 529-16 ¹²

⁴⁶ Must use bronze tip fuel pump pushrod when using high pressure or high volume pump

⁷⁵ Most aluminum heads come standard with 11/32" valve stems. Use appropriate valve locks, retainers, and seals.

RED NUMBERS DENOTE PREMIUM OPTION

CHEVROLET 396-454 C.I. 8 CYL. 1967-1996 (CONTINUED)

APPLICATIONS/CAMSHAFTS	VALVE SETTING		RPM OPERATING RANGE	CAM PART #	CAM GRIND #	DURATION				VALVE LIFT		LOBE SEP. ANGLE
	IN.	EX.				ADVERTISED IN.	EX.	@ .050" IN.	EX.	W/ 1.7 ROCKER IN.	EX.	
MAGNUM Mechanical Flat Tappet Camshafts												
SOLID – Good for everyday driving. Works well with headers. In 396-402c.i. use slightly lower gears. Slightly rough idle.	.022	.022	1800 to 5800	11-217-4	270S	270	270	224	224	.530	.530	110°
SOLID – Excellent for street machines. Use 2500+ stall, headers, 9:1+ compression & lower gears. Rough idle.	.022	.022	2000 to 6000	11-218-4	282S	282	282	236	236	.561	.561	110°
SOLID – Good for street/strip cars. 3000+ stall or 4 speed. 10:1+ compression, headers and low gears. Very rough idle.	.022	.022	2500 to 6500	11-219-4	294S	294	294	248	248	.595	.595	110°
SOLID – Great for Pro Street or bracket racing. 3500+ stall or 4 speed. 11:1+ compression, 4.10 or lower gear. Radical idle.	.022	.022	3000 to 7000	11-220-4	306S	306	306	260	260	.629	.629	110°
MAGNUM MARINE Mechanical Flat Tappet Camshafts												
SOLID – Jet boat or inboard/outboard drive. Pleasure usage, skiing, economy.	.028	.030	2500 to 6500	11-550-5	270B	270	280	235	242	.561	.575	110°
SOLID – Jet boat with A or B impeller. Skiing, pleasure, performance.	.028	.030	2800 to 6300	11-551-5	280S	280	285	242	250	.575	.604	110°
SOLID – Excellent for jet boat, A or B impeller. 427-454c.i., 10:1+ compression.	.028	.030	3500 to 6500	11-604-5	294B	294	304	256	266	.580	.605	108°
SOLID – Jet boat with B impeller. Bracket race, 10.5:1+ compression. Use tunnel ram.	.028	.030	3800 to 7000	11-220-4	306S	306	306	260	260	.629	.629	110°
SOLID – Jet boat with B impeller. Flat and hydro. Bracket race. Use tunnel ram.	.028	.030	4200 to 7200	11-605-5	310B	310	314	270	276	.638	.631	108°
SOLID – For use in large engine. Flat or hydro. Use tunnel ram. 11.5:1+ compression.	.028	.030	4500 to 7500	11-607-5	320B	320	324	280	286	.638	.656	110°
XTREME ENERGY™ Mechanical Flat Tappet Camshafts												
SOLID – Strong torque through low end and mid-range, good idle.	.016	.016	1000 to 5600	11-674-4	XS256S	256	262	218	224	.527	.532	110°
SOLID – Excellent response, good mid-range, noticeable idle.	.016	.016	1300 to 5800	11-675-4	XS262S	262	268	224	230	.532	.532	110°
SOLID – Great for street machines, largest cam for stock converter.	.016	.016	1600 to 6000	11-676-4	XS268S	268	274	230	236	.553	.568	110°
SOLID – Very strong mid-range torque and throttle response, 2500+ stall.	.016	.016	2000 to 6400	11-677-4 11-677-20⁹⁴	XS274S	274	280	236	242	.568	.578	110°
SOLID – Street/strip, 3000+ stall, likes headers and gears, rough idle.	.016	.016	2400 to 6800	11-678-5 11-678-20⁹⁴	XS282S	282	290	244	252	.590	.598	110°
SOLID – Pro Street/bracket, needs good intake, headers, gear and 3500+ stall.	.016	.016	2800 to 7200	11-679-5	XS290S	290	298	252	260	.598	.598	110°

TECH TIP

If you have a 1965-1966 Big Block Chevy engine, please notify your sales person before ordering.

² Requires machining on cylinder heads
⁷ Stock springs cannot be used

¹⁶ Truck engines have .400" taller block
¹⁷ Mark V & Mark VI heads must use kit w/ studs

¹⁸ 50-State legal for 1993 & earlier BB Chevrolet V8, 396-454c.i. C.A.R.B. E.O. #D-279-4

CHEVROLET 396-454 C.I. 8 CYL. 1967-1996 (CONTINUED)

CAMSHAFTS GENERAL MOTORS

K-KIT	SK-KIT	CL-KIT	RP-KIT	LIFTERS	TIMING SET	ROCKER ARMS	PUSHRODS	VALVE SPRINGS	RETAINERS	VALVE LOCKS	VALVE SEALS
MAGNUM Mechanical Flat Tappet Camshafts											
K11-217-4	SK11-217-4 ⁷	CL11-217-4 ⁷	RPM1411-16 ¹⁷	813-16 800-16	2110 3110	1411-16 ^{17,18} 1620-16 ^{17,18}	7154-16 ¹⁶ 7954-16	911-16 924-16 ²	748-16 741-16	612-16 ⁷⁵	504-16 505-16 ²
K11-218-4	SK11-218-4 ⁷	CL11-218-4 ⁷	RPM1411-16 ¹⁷	813-16 800-16	2110 3110	1411-16 ^{17,18} 1620-16 ^{17,18}	7154-16 ¹⁶ 7954-16	911-16 924-16 ²	748-16 741-16	612-16 ⁷⁵	504-16 505-16 ²
K11-219-4	SK11-219-4 ⁷	CL11-219-4 ⁷	RPM1411-16 ¹⁷	813-16 800-16	2110 3110	1411-16 ^{17,18} 1620-16 ^{17,18}	7154-16 ¹⁶ 7954-16	924-16 ² 26120-16	741-16 795-16	612-16 ⁷⁵ 616-16 ⁷⁵	505-16 ²
K11-220-4	SK11-220-4 ⁷	CL11-220-4 ⁷	RPM1411-16 ¹⁷	813-16 800-16	2110 3110	1411-16 ^{17,18} 1620-16 ^{17,18}	7154-16 ¹⁶ 7954-16	924-16 ² 930-16	741-16 1731-16	612-16 ⁷⁵	505-16 ²
MAGNUM MARINE Mechanical Flat Tappet Camshafts											
K11-550-5	SK11-550-5 ⁷	CL11-550-5 ⁷	RPM1411-16 ¹⁷	813-16 800-16	2110 3110	1411-16 ^{17,18} 1620-16 ^{17,18}	7154-16 ¹⁶ 7954-16	924-16 ² 26120-16	741-16 795-16	612-16 ⁷⁵ 616-16 ⁷⁵	505-16 ²
K11-551-5	SK11-551-5 ⁷	CL11-551-5 ⁷	RPM1411-16 ¹⁷	813-16 800-16	2110 3110	1411-16 ^{17,18} 1620-16 ^{17,18}	7154-16 ¹⁶ 7954-16	924-16 ² 26120-16	741-16 795-16	612-16 ⁷⁵ 616-16 ⁷⁵	505-16 ²
K11-604-5	SK11-604-5 ⁷	CL11-604-5 ⁷	RPM1411-16 ¹⁷	813-16 800-16	2110 3110	1411-16 ^{17,18} 1620-16 ^{17,18}	7154-16 ¹⁶ 7954-16	924-16 ² 26120-16	741-16 795-16	612-16 ⁷⁵ 616-16 ⁷⁵	505-16 ²
K11-220-4	SK11-220-4 ⁷	CL11-220-4 ⁷	RPM1411-16 ¹⁷	813-16 800-16	2110 3110	1411-16 ^{17,18} 1620-16 ^{17,18}	7154-16 ¹⁶ 7954-16	924-16 ² 930-16	741-16	612-16 ⁷⁵	505-16 ²
K11-605-5	SK11-605-5 ⁷	CL11-605-5 ⁷	RPM1411-16 ¹⁷	813-16 800-16	2110 3110	1411-16 ^{17,18} 1620-16 ^{17,18}	7154-16 ¹⁶ 7954-16	930-16 ²	741-16	612-16 ⁷⁵	505-16 ²
K11-607-5	SK11-607-5 ⁷	CL11-607-5 ⁷	RPM1411-16 ¹⁷	813-16 800-16	2110 3110	1411-16 ^{17,18} 1620-16 ^{17,18}	7154-16 ¹⁶ 7954-16	930-16 ²	741-16	612-16 ⁷⁵	505-16 ²
XTREME ENERGY™ Mechanical Flat Tappet Camshafts											
K11-674-4	SK11-674-4 ⁷	CL11-674-4 ⁷	RPM1411-16 ¹⁷	813-16 800-16	2110 3110	1411-16 ^{17,18} 1620-16 ^{17,18}	7154-16 ¹⁶ 7954-16	911-16 924-16 ²	748-16 741-16	612-16 ⁷⁵	504-16 505-16 ²
K11-675-4	SK11-675-4 ⁷	CL11-675-4 ⁷	RPM1411-16 ¹⁷	813-16 800-16	2110 3110	1411-16 ^{17,18} 1620-16 ^{17,18}	7154-16 ¹⁶ 7954-16	911-16 924-16 ²	748-16 741-16	612-16 ⁷⁵	504-16 505-16 ²
K11-676-4	SK11-676-4 ⁷	CL11-676-4 ⁷	RPM1411-16 ¹⁷	813-16 800-16	2110 3110	1411-16 ^{17,18} 1620-16 ^{17,18}	7154-16 ¹⁶ 7954-16	924-16 ² 26120-16	741-16 795-16	612-16 ⁷⁵ 616-16 ⁷⁵	505-16 ²
K11-677-4	SK11-677-4 ⁷	CL11-677-4 ⁷	RPM1411-16 ¹⁷	813-16 800-16	2110 3110	1411-16 ^{17,18} 1620-16 ^{17,18}	7154-16 ¹⁶ 7954-16	924-16 ² 26120-16	741-16 795-16	612-16 ⁷⁵ 616-16 ⁷⁵	505-16 ²
K11-678-5	SK11-678-5 ⁷	CL11-678-5 ⁷	RPM1411-16 ¹⁷	813-16 800-16	2110 3110	1411-16 ^{17,18} 1620-16 ^{17,18}	7154-16 ¹⁶ 7954-16	924-16 ² 26120-16	741-16 795-16	612-16 ⁷⁵ 616-16 ⁷⁵	505-16 ²
K11-679-5	SK11-679-5 ⁷	CL11-679-5 ⁷	RPM1411-16 ¹⁷	813-16 800-16	2110 3110	1411-16 ^{17,18} 1620-16 ^{17,18}	7154-16 ¹⁶ 7954-16	924-16 ² 26120-16	741-16 795-16	612-16 ⁷⁵ 616-16 ⁷⁵	505-16 ²

⁷⁵ Most aluminum heads come standard with 11/32" valve stems. Use appropriate valve locks, retainers, and seals.

⁹⁴ Nitrided version

RED NUMBERS DENOTE PREMIUM OPTION

CHEVROLET 396-454 C.I. 8 CYL. 1967-1996 (CONTINUED)

APPLICATIONS/CAMSHAFTS	VALVE SETTING		RPM OPERATING RANGE	CAM PART #	CAM GRIND #	DURATION				VALVE LIFT		LOBE SEP. ANGLE
	IN.	EX.				ADVERTISED IN.	EX.	@ .050" IN.	EX.	W/ 1.7 ROCKER IN.	EX.	
XTREME ENERGY™ 4 & 7 SWAP FIRING ORDER Mechanical Flat Tappet Camshafts												
18736542 Firing Order												
SOLID – Very strong mid-range torque and throttle response, 2500+ stall.	.016	.016	2000 to 6400	11-653-47	XE274S	274	280	236	242	.568	.578	110°
SOLID – Street/strip, 3000+ stall, likes headers and gears, rough idle.	.016	.016	2400 to 6800	11-654-47	XE282S	282	290	244	252	.590	.598	110°
SOLID – Pro Street/bracket, needs good intake, headers, gear and 3500+stall.	.016	.016	2800 to 7200	11-655-47	XE290S	290	298	252	260	.598	.598	110°
NOSTALGIA PLUS™ Mechanical Flat Tappet Camshafts												
SOLID – Outstanding power and modern tight lash with the sound of the GM LS6 cam.	.012	.012	1800 to 6500	11-671-4	N+LS6S	276	283	239	246	.544	.539	112°
SOLID – Nostalgia Plus™ version of legendary ZL-1 camshaft. Modern lobe design makes this cam better than the original.	.012	.012	3500 to 7000	11-573-5	N+ZL-1S	299	309	262	272	.581	.622	110°
FACTORY MUSCLE™ Mechanical Flat Tappet Camshafts (Today's OEM Versions of Yesterday's Muscle Car Cams)												
SOLID – Factory I.D. #3863143 for: 396c.i., 1967-69 Z28, factory 375 HP 402c.i., 1970, factory 375 HP 427c.i., 1967-69, factory 425/435 HP 454c.i., 1970 LS6, factory 450/465 HP 454c.i., 1971 LS6, factory 425 HP	.024	.024	2200 to 6200	11-106-3	143S	316	302	242	242	.520	.520	114°
BLOWER & TURBO Mechanical Flat Tappet Camshafts												
SOLID – Good for street and mild strip use with 671 or larger blower.	.028	.030	3500 to 7000	11-405-5⁷	290DS	290	304	255	266	.612	.605	114°
SOLID – Use in bracket racing and very hot street with 671 or larger blower.	.028	.030	4000 to 7500	11-406-5⁷	310BS	310	320	270	280	.637	.637	114°
PULLER & MUD RACE Mechanical Flat Tappet Camshafts												
SOLID – Good torque and power in 396-402c.i., 10:1+ compression.	.028	.030	3000 to 6500	11-610-5	285B-8	285	295	250	260	.604	.629	108°
SOLID – Excellent choice for 427-454c.i., good power, 11:1+ compression.	.028	.030	3800 to 6800	11-611-5	295B-8	295	310	260	270	.629	.638	108°

⁷ Requires machining on cylinder heads
⁷ Stock springs cannot be used

¹⁶ Truck engines have .400" taller block
¹⁷ Mark V & Mark VI heads must use kit w/ studs

¹⁸ 50-State legal for 1993 & earlier BB Chevrolet V8, 396-454c.i. C.A.R.B. E.O. #D-279-4

CHEVROLET 396-454 C.I. 8 CYL. 1967-1996 (CONTINUED)

CAMSHAFTS
GENERAL MOTORS

LIFTERS	TIMING SET	ROCKER ARMS	PUSHRODS	VALVE SPRINGS	RETAINERS	VALVE LOCKS	VALVE SEALS	LASH CAPS	REV KIT	DIST. GEAR	STUD GIRDLES
XTREME ENERGY™ 4 & 7 SWAP FIRING ORDER Mechanical Flat Tappet Camshafts											
813-16 2900-16	2110 7110	1620-16 ^{17,18} 1820-16 ¹⁷	7154-16 ¹⁶ 7954-16	924-16 ² 26120-16	741-16 795-16	612-16 ⁷⁵ 616-16 ⁷⁵	505-16 ²	622-16	N/A	12200 12140	4021
813-16 2900-16	2110 7110	1620-16 ^{17,18} 1820-16 ¹⁷	7154-16 ¹⁶ 7954-16	924-16 ² 26120-16	741-16 795-16	612-16 ⁷⁵ 616-16 ⁷⁵	505-16 ²	622-16	N/A	12200 12140	4021
813-16 2900-16	2110 7110	1620-16 ^{17,18} 1820-16 ¹⁷	7154-16 ¹⁶ 7954-16	924-16 ² 26120-16	741-16 795-16	612-16 ⁷⁵ 616-16 ⁷⁵	505-16 ²	622-16	N/A	12200 12140	4021

K-KIT	SK-KIT	CL-KIT	RP-KIT	LIFTERS	TIMING SET	ROCKER ARMS	PUSHRODS	VALVE SPRINGS	RETAINERS	VALVE LOCKS	VALVE SEALS
NOSTALGIA PLUS™ Mechanical Flat Tappet Camshafts											
K11-671-4	SK11-671-4 ⁷	CL11-671-4 ⁷	RPM1411-16 ¹⁷	813-16 800-16	2110 3110	1411-16 ^{17,18} 1620-16 ^{17,18}	7154-16 ¹⁶ 7954-16	924-16 ² 26120-16	741-16 795-16	612-16 ⁷⁵ 616-16 ⁷⁵	505-16 ²
K11-573-5	SK11-573-5 ⁷	CL11-573-5 ⁷	RPM1411-16 ¹⁷	813-16 800-16	2110 3110	1411-16 ^{17,18} 1620-16 ^{17,18}	7154-16 ¹⁶ 7954-16	924-16 ² 26120-16	741-16 795-16	612-16 ⁷⁵ 616-16 ⁷⁵	505-16 ²

LIFTERS	TIMING SET	ROCKER ARMS	PUSHRODS	VALVE SPRINGS	RETAINERS	VALVE LOCKS	VALVE SEALS	LASH CAPS	REV KIT	DIST. GEAR	STUD GIRDLES
FACTORY MUSCLE™ Mechanical Flat Tappet Camshafts (Today's OEM Versions of Yesterday's Muscle Car Cams)											
813-16 2900-16	2110 7110	1411-16 ^{17,18} 1620-16 ^{17,18}	7154-16 7954-16	924-16 ² 26120-16	741-16 795-16	612-16 616-16	505-16 ²	622-16	N/A	12200 12140	4021

K-KIT	SK-KIT	CL-KIT	RP-KIT	LIFTERS	TIMING SET	ROCKER ARMS	PUSHRODS	VALVE SPRINGS	RETAINERS	VALVE LOCKS	VALVE SEALS
BLOWER & TURBO Mechanical Flat Tappet Camshafts											
K11-405-5	SK11-405-5 ⁷	CL11-405-5 ⁷	RPM1411-16 ¹⁷	813-16 800-16	2110 3110	1411-16 ^{17,18} 1620-16 ^{17,18}	7154-16 ¹⁶ 7954-16 ¹⁶	924-16 ² 930-16 ²	741-16 732-16	612-16 ⁷⁵	505-16 ²
K11-406-5	SK11-406-5 ⁷	CL11-406-5 ⁷	RPM1411-16 ¹⁷	813-16 800-16	2110 3110	1411-16 ^{17,18} 1620-16 ^{17,18}	7154-16 ¹⁶ 7954-16 ¹⁶	924-16 ² 930-16 ²	741-16 732-16	612-16 ⁷⁵	505-16 ²

LIFTERS	TIMING SET	ROCKER ARMS	PUSHRODS	VALVE SPRINGS	RETAINERS	VALVE LOCKS	VALVE SEALS	LASH CAPS	REV KIT	DIST. GEAR	STUD GIRDLES
PULLER & MUD RACE Mechanical Flat Tappet Camshafts											
813-16 800-16	3110 3110KT	1620-16 ^{17,18} 1820-16 ¹⁷	7154-16 ¹⁶ 7954-16 ¹⁶	924-16 ² 930-16 ²	741-16 732-16	612-16 ⁷⁵	505-16 ²	622-16	N/A	12200 12140	4021
813-16 800-16	3110 3110KT	1620-16 ^{17,18} 1820-16 ¹⁷	7154-16 ¹⁶ 7954-16 ¹⁶	924-16 ² 930-16 ²	741-16 732-16	612-16 ⁷⁵	505-16 ²	622-16	N/A	12200 12140	4021

⁷⁵ Most aluminum heads come standard with 11/32" valve stems. Use appropriate valve locks, retainers, and seals.

RED NUMBERS DENOTE PREMIUM OPTION



CHEVROLET 396-454 C.I. 8 CYL. 1967-1996 (CONTINUED)

APPLICATIONS/CAMSHAFTS	VALVE SETTING		RPM OPERATING RANGE	CAM PART #	CAM GRIND #	DURATION				VALVE LIFT		LOBE SEP. ANGLE
	IN.	EX.				ADVERTISED IN.	EX.	@ .050" IN.	EX.	W/ 1.7 ROCKER IN.	EX.	
DRAG RACE Mechanical Flat Tappet Camshafts												
SOLID – 427+c.i. engines, heavy car, 3500+ stall and 10:1+ compression.	.018	.020	3500 to 6500	11-606-5	MA283A-8	283	291	256	264	.578	.578	108°
SOLID – Use in 396-427c.i., heavy car, 3500+ stall and 10.5:1+ compression.	.028	.030	3500 to 6500	11-604-5	294B-8	294	304	256	266	.580	.605	108°
SOLID – Works well in 396-427c.i., 4000+ stall and 11:1+ compression.	.028	.030	3600 to 6800	11-601-5	295A-8	295	304	260	266	.629	.605	108°
SOLID – 427+c.i. engines, 4000+ stall, 11:1+ compression.	.018	.020	3600 to 6800	11-608-5	TL292A-8	292	308	262	270	.635	.637	108°
SOLID – 2600-3000 lbs. car, 11.5:1+ compression with 4500+ stall. Excellent for 427-454c.i.	.028	.030	4200 to 7200	11-605-5	310B-8	310	314	270	276	.638	.631	108°
SOLID – Our best solid for 454c.i. with 4500+ stall and 11.5:1+ compression.	.028	.030	4500 to 7500	11-613-5	310C-10	310	320	270	280	.638	.638	110°
DRAG RACE 4 & 7 SWAP FIRING ORDER Mechanical Flat Tappet Camshafts												
18736542 Firing Order												
SOLID – 427+ engines, 4000+ stall, 11:1+ compression.	.018	.020	3600 to 6800	11-681-47	47S TL292A	292	308	262	270	.635	.637	108°
SOLID – 2600-3000 lbs. car, 11.5:1+ compression with 4500+ stall. Excellent for 427-454c.i.	.028	.030	4200 to 7200	11-682-47	47S 310B-8	310	314	270	276	.638	.631	108°
SOLID – Our best solid for 454c.i. with 4500+ stall and 11.5:1+ compression.	.028	.030	4500 to 7500	11-683-47	47S 310C-10	310	320	270	280	.638	.638	110°
OVAL TRACK Mechanical Flat Tappet Camshafts												
SOLID – Best short track cam w/ broad power range. Excellent low end torque, good for 396-427c.i.	.022	.024	3000 to 6500	11-610-5	285B-8	285	295	250	260	.604	.629	108°
SOLID – Good for 1/4 to 1/2 mile track with slight banking, wide torque range.	.022	.024	3500 to 6500	11-601-5	295A-8	295	304	260	266	.629	.605	108°
MAGNUM Mechanical Roller Camshafts												
MECHANICAL ROLLER – Great all around power. 3000+ stall with lower gear. Use headers and 9.5:1+ compression. Rough idle.	.020	.020	2200 to 6500	11-692-8^{10,46}	288AR	288	288	246	246	.623	.623	110°
MECHANICAL ROLLER – Ultimate Pro Street cam. 10.5:1+ compression, 3500+ stall or 4 speed. 4.10 gear.	.020	.020	3000 to 7200	11-693-8^{10,46}	308AR	308	308	262	262	.652	.652	110°

TECH TIP If you have a 1965-1966 Big Block Chevy engine, please notify your sales person before ordering.

² Requires machining on cylinder heads
⁶ Offset lifters available
⁷ Stock springs cannot be used
¹⁰ Requires thrust button & wear plate
¹⁶ Truck engines have .400" taller block
¹⁷ Mark V & Mark VI heads must use kit w/ studs
¹⁸ 50-State legal for 1993 & earlier BB Chevrolet V8, 396-454c.i. C.A.R.B. E.O. #D-279-4

CHEVROLET 396-454 C.I. 8 CYL. 1967-1996 (CONTINUED)

LIFTERS	TIMING SET	ROCKER ARMS	PUSHRODS	VALVE SPRINGS	RETAINERS	VALVE LOCKS	VALVE SEALS	LASH CAPS	REV KIT	DIST. GEAR	STUD GIRDLES
DRAG RACE Mechanical Flat Tappet Camshafts											
813-16 800-16	3110 3110KT	1620-16 ^{17,18} 1820-16 ¹⁷	7954-16 ¹⁶	924-16 ² 930-16 ²	741-16 795-16	612-16 ⁷⁵	505-16 ²	622-16	N/A	12200 12140	4021
813-16 800-16	3110 3110KT	1620-16 ^{17,18} 1820-16 ¹⁷	7954-16 ¹⁶	924-16 ² 930-16 ²	741-16 732-16	612-16 ⁷⁵	505-16 ²	622-16	N/A	12200 12140	4021
813-16 800-16	3110 3110KT	1620-16 ^{17,18} 1820-16 ¹⁷	7954-16 ¹⁶	924-16 ² 930-16 ²	741-16 732-16	612-16 ⁷⁵	505-16 ²	622-16	N/A	12200 12140	4021
813-16 800-16	3110 3110KT	1620-16 ^{17,18} 1820-16 ¹⁷	7954-16 ¹⁶	924-16 ² 930-16 ²	741-16 732-16	612-16 ⁷⁵	505-16 ²	622-16	N/A	12200 12140	4021
813-16 800-16	3110 3110KT	1620-16 ^{17,18} 1820-16 ¹⁷	7954-16 ¹⁶	924-16 ² 930-16 ²	741-16 732-16	612-16 ⁷⁵	505-16 ²	622-16	N/A	12200 12140	4021
813-16 800-16	3110 3110KT	1620-16 ^{17,18} 1820-16 ¹⁷	7954-16 ¹⁶	924-16 ² 930-16 ²	741-16 732-16	612-16 ⁷⁵	505-16 ²	622-16	N/A	12200 12140	4021
DRAG RACE 4 & 7 SWAP FIRING ORDER Mechanical Flat Tappet Camshafts											
813-16 800-16	3110 3110KT	1620-16 ^{17,18} 1820-16 ¹⁷	7954-16 ¹⁶	924-16 ² 930-16 ²	741-16 732-16	612-16 ⁷⁵	505-16 ²	622-16	N/A	12200 12140	4021
813-16 800-16	3110 3110KT	1620-16 ^{17,18} 1820-16 ¹⁷	7954-16 ¹⁶	924-16 ² 930-16 ²	741-16 732-16	612-16 ⁷⁵	505-16 ²	622-16	N/A	12200 12140	4021
813-16 800-16	3110 3110KT	1620-16 ^{17,18} 1820-16 ¹⁷	7954-16 ¹⁶	924-16 ² 930-16 ²	741-16 732-16	612-16 ⁷⁵	505-16 ²	622-16	N/A	12200 12140	4021
OVAL TRACK Mechanical Flat Tappet Camshafts											
813-16 800-16	3110 3110KT	1620-16 ^{17,18} 1820-16 ¹⁷	7954-16 ¹⁶	924-16 ² 930-16 ²	741-16 732-16	612-16 ⁷⁵	505-16 ²	622-16	N/A	12200 12140	4021
813-16 800-16	3110 3110KT	1620-16 ^{17,18} 1820-16 ¹⁷	7954-16 ¹⁶	924-16 ² 930-16 ²	741-16 732-16	612-16 ⁷⁵	505-16 ²	622-16	N/A	12200 12140	4021
MAGNUM Mechanical Roller Camshafts											
K11-692-8 ¹⁰	SK11-692-8 ^{7,10}	CL11-692-8 ^{7,10}	819-16 ⁶ 866-16 ⁶	412M	2110 7110	1411-16 ^{17,18} 1820-16 ¹⁷	7154-16 ¹⁶ 7954-16 ¹⁶	953-16 ² 933-16 ²	741-16 729-16	612-16 ⁷⁵	505-16 ²
K11-693-8 ¹⁰	SK11-693-8 ^{7,10}	CL11-693-8 ^{7,10}	819-16 ⁶ 866-16 ⁶	412M	2110 7110	1411-16 ^{17,18} 1820-16 ¹⁷	7154-16 ¹⁶ 7954-16 ¹⁶	953-16 933-16 ²	741-16 729-16	612-16 ⁷⁵	505-16 ²

⁴⁶ Must use bronze tip fuel pump pushrod when using high pressure or high volume pump

⁷⁵ Most aluminum heads come standard with 11/32" valve stems. Use appropriate valve locks, retainers, and seals.



CHEVROLET 396-454 C.I. 8 CYL. 1967-1996 (CONTINUED)

APPLICATIONS/CAMSHAFTS	VALVE SETTING		RPM OPERATING RANGE	CAM PART #	CAM GRIND #	DURATION				VALVE LIFT		LOBE SEP. ANGLE
	IN.	EX.				ADVERTISED IN.	EX.	@ .050" IN.	EX.	W/ 1.7 ROCKER IN.	EX.	
XTREME ENERGY™ Mechanical Roller Camshafts												
MECHANICAL ROLLER – Great for Power Touring. Needs 2500+ stall, easy on parts. Very reliable power. Rough idle.	.016	.018	2200 to 6200	11-770-8 ^{10,46}	XR274R	274	280	236	242	.639	.646	110°
MECHANICAL ROLLER – Best in street machines with 2800+ stall, 10:1+ compression with 3.73-3.90 rear gears.	.016	.018	2500 to 6500	11-771-8 ^{10,46}	XR280R	280	286	242	248	.646	.653	110°
MECHANICAL ROLLER – Good in weekend warrior with 3000+ stall. Needs good intake and exhaust with low gears.	.016	.018	3000 to 7000	11-772-8 ^{10,46}	XR286R	286	292	248	254	.653	.660	110°
MECHANICAL ROLLER – Best for Pro Street. Needs good intake and exhaust, 11:1+ compression and 3500+ stall.	.016	.018	3200 to 7200	11-773-8 ^{10,46}	XR292R	292	298	254	260	.660	.666	110°
MARINE Mechanical Roller Camshafts												
MECHANICAL ROLLER – Jet boat with A impeller, flat bottom, hydro. River race.	.028	.030	3500 to 6500	11-706-9 ^{14,46}	285CR-8	285	295	252	262	.638	.622	108°
MECHANICAL ROLLER – Jet boat with B impeller, flat, hydro. River race, bracket.	.028	.030	4200 to 7000	11-744-9 ^{14,46}	295DR-10	295	305	260	270	.670	.670	110°
MECHANICAL ROLLER – Hydro, flat bottom jet boat with B impeller. Bracket racing. Easy on parts.	.028	.030	4500 to 7000	11-702-9 ^{14,46}	306AR-10	306	319	270	280	.680	.680	110°
MECHANICAL ROLLER – Comp jet. Blown gas flat or hydro.	.028	.030	5000 to 7500	11-745-9 ^{14,46}	310AR-8	310	310	280	280	.772	.772	108°
MECHANICAL ROLLER – 454c.i. and larger engines. River racer – blown gasoline, flat or hydro.	.028	.030	5500 to 7500	11-746-9 ^{14,46}	319CR-10	319	326	285	288	.782	.714	110°
BLOWER Mechanical Roller Camshafts												
MECHANICAL ROLLER – Best for Pro Street and bracket racing with 671 or larger blower.	.020	.020	3500 to 7000	11-694-8 ^{10,46}	300BR-14	300	308	255	262	.652	.652	114°

APPLICATIONS/CAMSHAFTS	VALVE SETTING		RPM OPERATING RANGE	CAM PART #	CAM GRIND #	DURATION				VALVE LIFT		LOBE SEP. ANGLE
	IN.	EX.				ADVERTISED IN.	EX.	@ .050" IN.	EX.	W/ 1.7 ROCKER IN.	EX.	
PULLER & MUD RACE Mechanical Roller Camshafts												
MECHANICAL ROLLER – Best cam for 396-402c.i., strong torque easy on parts.	.028	.030	3200 to 6500	11-700-9 ^{14,46}	288AR-8	288	296	251	260	.680	.680	108°
MECHANICAL ROLLER – Use in 454c.i. or larger engines. 11.5:1+ compression.	.028	.030	4200 to 7200	11-702-9 ^{14,46}	306AR-10	306	319	270	280	.680	.680	110°
MECHANICAL ROLLER – Use in 427c.i. with 11:1+ compression.	.028	.030	4000 to 7000	11-711-9 ^{14,46}	306CR-8	306	319	271	280	.680	.680	108°

² Requires machining on cylinder heads
⁶ Offset lifters available
⁷ Stock springs cannot be used
¹⁰ Requires thrust button & wear plate

¹⁴ Requires upgraded gear, thrust button & wear plate
¹⁶ Truck engines have .400" taller block
¹⁷ Mark V & Mark VI heads must use kit w/ studs

¹⁸ 50-State legal for 1993 & earlier BB Chevrolet V8, 396-454c.i. C.A.R.B. E.O. #D-279-4
²⁰ Tall block engines require Part #4005

CHEVROLET 396-454 C.I. 8 CYL. 1967-1996 (CONTINUED)

CAMSHAFTS GENERAL MOTORS

K-KIT	SK-KIT	CL-KIT	LIFTERS	DIST. GEAR	TIMING SET	ROCKER ARMS	PUSHRODS	VALVE SPRINGS	RETAINERS	VALVE LOCKS	VALVE SEALS
XTREME ENERGY™ Mechanical Roller Camshafts											
K11-770-8 ¹⁰	SK11-770-8 ^{7,10}	CL11-770-8 ^{7,10}	819-16 ⁶ 866-16 ⁶	412M	2110 7110	1620-16 ^{17,18} 1820-16 ¹⁷	7154-16 ¹⁶ 7954-16 ¹⁶	953-16 ² 933-16 ²	741-16 729-16	612-16 ⁷⁵	505-16 ²
K11-771-8 ¹⁰	SK11-771-8 ^{7,10}	CL11-771-8 ^{7,10}	819-16 ⁶ 866-16 ⁶	412M	2110 7110	1620-16 ^{17,18} 1820-16 ¹⁷	7154-16 ¹⁶ 7954-16 ¹⁶	953-16 ² 933-16 ²	741-16 729-16	612-16 ⁷⁵	505-16 ²
K11-772-8 ¹⁰	SK11-772-8 ^{7,10}	CL11-772-8 ^{7,10}	819-16 ⁶ 866-16 ⁶	412M	2110 7110	1620-16 ^{17,18} 1820-16 ¹⁷	7154-16 ¹⁶ 7954-16 ¹⁶	953-16 ² 933-16 ²	741-16 729-16	612-16 ⁷⁵	505-16 ²
K11-773-8 ¹⁰	SK11-773-8 ^{7,10}	CL11-773-8 ^{7,10}	819-16 ⁶ 866-16 ⁶	412M	2110 7110	1620-16 ^{17,18} 1820-16 ¹⁷	7154-16 ¹⁶ 7954-16 ¹⁶	953-16 ² 933-16 ²	741-16 729-16	612-16 ⁷⁵	505-16 ²
MARINE Mechanical Roller Camshafts											
K11-706-9 ¹⁴	SK11-706-9 ^{7,14}	CL11-706-9 ^{7,14}	819-16 ⁶ 866-16 ⁶	12200 12140	3110KT 6200	1620-16 ^{17,18} 1820-16 ¹⁷	7954-16 ¹⁶	944-16 ² 26097-16 ²	731-16 732-16	612-16 ⁷⁵	505-16 ²
K11-744-9 ¹⁴	SK11-744-9 ^{7,14}	CL11-744-9 ^{7,14}	819-16 ⁶ 866-16 ⁶	12200 12140	3110KT 6200	1620-16 ^{17,18} 1820-16 ¹⁷	7954-16 ¹⁶	944-16 ² 26097-16 ²	731-16 732-16	612-16 ⁷⁵	505-16 ²
K11-702-9 ¹⁴	SK11-702-9 ^{7,14}	CL11-702-9 ^{7,14}	819-16 ⁶ 866-16 ⁶	12200 12140	3110KT 6200	1620-16 ^{17,18} 1820-16 ¹⁷	7954-16 ¹⁶	944-16 ² 26097-16 ²	731-16 732-16	612-16 ⁷⁵	505-16 ²
K11-745-9 ¹⁴	SK11-745-9 ^{7,14}	CL11-745-9 ^{7,14}	819-16 ⁶ 866-16 ⁶	12200 12140	3110KT 6200	1620-16 ^{17,18} 1820-16 ¹⁷	7954-16 ¹⁶	944-16 ² 26097-16 ²	731-16 732-16	612-16 ⁷⁵	505-16 ²
K11-746-9 ¹⁴	SK11-746-9 ^{7,14}	CL11-746-9 ^{7,14}	819-16 ⁶ 866-16 ⁶	12200 12140	3110KT 6200	1620-16 ^{17,18} 1820-16 ¹⁷	7954-16 ¹⁶	944-16 ² 26097-16 ²	731-16 732-16	612-16 ⁷⁵	505-16 ²
BLOWER Mechanical Roller Camshafts											
K11-694-8 ¹⁰	SK11-694-8 ^{7,10}	CL11-694-8 ^{7,10}	819-16 ⁶ 866-16 ⁶	412M	3110KT 6200	1620-16 ^{17,18} 1820-16 ¹⁷	7154-16 ¹⁶ 7954-16 ¹⁶	953-16 ² 26112-16 ²	741-16 729-16	612-16 ⁷⁵	505-16 ²

LIFTERS	TIMING SET	ROCKER ARMS	PUSHRODS	VALVE SPRINGS	RETAINERS	VALVE LOCKS	VALVE SEALS	LASH CAPS	REV KIT	DIST. GEAR	STUD GIRDLES
PULLER & MUD RACE Mechanical Roller Camshafts											
819-16 ⁶ 98819-16 ⁶	3110KT 6200	1620-16 ^{17,18} 1820-16 ¹⁷	7954-16 ¹⁶	944-16 ² 26097-16 ²	731-16 732-16	612-16 ⁷⁵	505-16 ²	622-16	4003 ²⁰	12200 12140	4021
819-16 ⁶ 98819-16 ⁶	3110KT 6200	1620-16 ^{17,18} 1820-16 ¹⁷	7954-16 ¹⁶	944-16 ² 26097-16 ²	731-16 732-16	612-16 ⁷⁵	505-16 ²	622-16	4003 ²⁰	12200 12140	4021
819-16 ⁶ 98819-16 ⁶	3110KT 6200	1620-16 ^{17,18} 1820-16 ¹⁷	7954-16 ¹⁶	944-16 ² 26097-16 ²	731-16 732-16	612-16 ⁷⁵	505-16 ²	622-16	4003 ²⁰	12200 12140	4021

⁴⁶ Must use bronze tip fuel pump pushrod when using high pressure or high volume pump

⁷⁵ Most aluminum heads come standard with 11/32" valve stems. Use appropriate valve locks, retainers, and seals.



CHEVROLET 396-454 C.I. 8 CYL. 1967-1996 (CONTINUED)

APPLICATIONS/CAMSHAFTS	VALVE SETTING		RPM OPERATING RANGE	CAM PART #	CAM GRIND #	DURATION				VALVE LIFT		LOBE SEP. ANGLE
	IN.	EX.				ADVERTISED IN.	EX.	@ .050" IN.	EX.	W/ 1.7 ROCKER IN.	EX.	
DRAG RACE Mechanical Roller Camshafts												
MECHANICAL ROLLER – Best for 396c.i. in 3200+ lbs., 3800+ stall, good torque.	.028	.030	3200 to 6200	11-713-9^{14, 46}	288CR-8	288	296	254	262	.714	.714	108°
MECHANICAL ROLLER – Works good in 396-427c.i. with 4000+ stall, 11:1+ compression.	.028	.030	3500 to 6500	11-715-9^{14, 46}	296CR-8	296	304	262	270	.714	.714	108°
MECHANICAL ROLLER – Super Street, 4500+ stall, 11.5:1+ compression, 427-454.	.028	.030	4000 to 6800	11-717-9^{14, 46}	304CR-8	304	312	270	276	.714	.714	108°
MECHANICAL ROLLER – Bracket race 468-496c.i. heavy car, 12:1+ compression.	.024	.026	4800 to 7200	11-724-9^{14, 46}	306BR-10	306	315	270	280	.714	.710	110°
MECHANICAL ROLLER – Super Gas/Super Comp. Aftermarket heads, up to 500c.i.	.026	.028	5000 to 7500	11-825-9^{14, 46}	311R-10	311	315	272	280	.748	.710	110°
MECHANICAL ROLLER – Super Street/Super Gas, 427-468c.i., 5000+ stall, 2500-3000 lbs. car.	.028	.030	4500 to 7300	11-703-9^{14, 46}	312CR-10	312	319	278	282	.714	.680	110°
MECHANICAL ROLLER – Super Street/Super Gas, 427-468c.i. 5000+ stall, 12:1+ compression.	.028	.030	4500 to 7300	11-734-9^{14, 46}	313GR-10	313	322	276	284	.748	.714	110°
MECHANICAL ROLLER – Super Gas/Super Comp. 496-540c.i.	.022	.024	5000 to 7000	11-827-9^{14, 46}	316FR-12	316	332	282	298	.806	.758	112°
MECHANICAL ROLLER – Bracket 500+c.i., tunnel cam, 5500+ stall or manual.	.024	.028	5600 to 8000	11-733-9^{14, 46}	322A-R12	322	339	282	298	.806	.758	112°
MECHANICAL ROLLER – Super Gas/Super Comp. 5000+ stall or 4 speed, 454+c.i.	.028	.030	5000 to 7800	11-718-9^{14, 46}	322AR-10	322	330	282	292	.726	.714	110°
MECHANICAL ROLLER – Super Gas/Super Comp. 5000+ stall or 4 speed, 500+c.i.	.028	.030	5000 to 7800	11-736-9^{14, 46}	324IR-10	324	332	286	294	.775	.748	110°
MECHANICAL ROLLER – Super Comp. Best in light car, 5500+ stall, 454+c.i.	.028	.030	5500 to 8500	11-720-9^{14, 46}	321CR-10	321	322	284	288	.748	.714	110°
MECHANICAL ROLLER – Super Comp. 5000+ stall, 500+c.i.	.028	.030	5000 to 7500	11-740-9^{14, 46}	321JR-12	321	336	284	296	.748	.748	112°
MECHANICAL ROLLER – Fast Bracket/Super Comp. 5500+ stall or 4-speed, 454+ c.i. engine.	.028	.030	5200 to 7800	11-738-9^{14, 46}	324FR-10	324	336	284	296	.800	.748	110°
MECHANICAL ROLLER – Bracket race 500-572c.i.	.026	.028	5200 to 7500	11-721-9^{14, 46}	324AR-12	324	332	284	292	.775	.748	112°
MECHANICAL ROLLER – Super Stock 454 auto or manual w/ 1.8 and 1.7 rockers.	.024	.030	5500 to 8000	11-719-9^{14, 46}	316AR-11	316	338	284	295	.873	.782	111°
MECHANICAL ROLLER – Top Sportsman 550+c.i. nitrous or big mph bracket.	.024	.028	5600 to 8000	11-726-9^{14, 46}	316BR-14	316	348	284	308	.824	.782	114°
MECHANICAL ROLLER – 550-600c.i. engines. Pro Street. Pontiac heads, works with nitrous.	.028	.030	5200 to 8000	11-727-9^{14, 46}	324DR-12	324	340	284	300	.800	.748	112°
MECHANICAL ROLLER – Bracket/Quick 16 520-600c.i. w/ 300 hp nitrous.	.024	.026	5200 to 7800	11-725-9^{14, 46}	326AR-14	326	346	286	310	.810	.756	114°

² Requires machining on cylinder heads

⁶ Offset lifters available

¹⁴ Requires upgraded gear, thrust button & wear plate

¹⁶ Truck engines have .400" taller block

¹⁷ Mark V & Mark VI heads must use kit w/ studs

¹⁸ 50-State legal for 1993 & earlier BB Chevrolet V8, 396-454c.i. C.A.R.B. E.O. #D-279-4

CHEVROLET 396-454 C.I. 8 CYL. 1967-1996 (CONTINUED)

CAMSHAFTS GENERAL MOTORS

LIFTERS	TIMING SET	ROCKER ARMS	PUSHRODS	VALVE SPRINGS	RETAINERS	VALVE LOCKS	VALVE SEALS	LASH CAPS	REV KIT	DIST. GEAR	STUD GIRDLES
DRAG RACE Mechanical Roller Camshafts											
819-16 ⁶ 98819-16 ⁶	3110KT 6200	1620-16 ^{17,18} 1820-16 ¹⁷	7954-16 ¹⁶	947-16 ² 26082-16 ²	735-16 722-16	612-16 ⁷⁵	505-16 ²	622-16	4003 ²⁰	12200 12140	4021
819-16 ⁶ 98819-16 ⁶	3110KT 6200	1620-16 ^{17,18} 1820-16 ¹⁷	7954-16 ¹⁶	947-16 ² 26082-16 ²	735-16 722-16	612-16 ⁷⁵	505-16 ²	622-16	4003 ²⁰	12200 12140	4021
819-16 ⁶ 98819-16 ⁶	3110KT 6200	1620-16 ^{17,18} 1820-16 ¹⁷	7954-16 ¹⁶	947-16 ² 26082-16 ²	735-16 722-16	612-16 ⁷⁵	505-16 ²	622-16	4003 ²⁰	12200 12140	4021
819-16 ⁶ 98819-16 ⁶	3110KT 6200	1620-16 ^{17,18} 1820-16 ¹⁷	7954-16 ¹⁶	947-16 ² 26082-16 ²	735-16 722-16	612-16 ⁷⁵	505-16 ²	622-16	4003 ²⁰	12200 12140	4021
98819-16 ⁶	3110KT 6200	1620-16 ^{17,18} 1820-16 ¹⁷	7954-16 ¹⁶	947-16 ² 26082-16 ²	735-16 722-16	612-16 ⁷⁵	505-16 ²	622-16	4003 ²⁰	12200 12140	4021
819-16 ⁶ 98819-16 ⁶	3110KT 6200	1620-16 ^{17,18} 1820-16 ¹⁷	7954-16 ¹⁶	947-16 ² 26082-16 ²	735-16 722-16	612-16 ⁷⁵	505-16 ²	622-16	4003 ²⁰	12200 12140	4021
98819-16 ⁶	3110KT 6200	1620-16 ^{17,18} 1820-16 ¹⁷	7954-16 ¹⁶	947-16 ² 26082-16 ²	735-16 722-16	612-16 ⁷⁵	505-16 ²	622-16	4003 ²⁰	12200 12140	4021
98819-16 ⁶	3110KT 6200	1620-16 ^{17,18} 1820-16 ¹⁷	7954-16 ¹⁶	947-16 ² 26082-16 ²	735-16 722-16	612-16 ⁷⁵	506-16 ²	622-16	4003 ²⁰	12200 12140	4021
98819-16 ⁶	3110KT 6200	1620-16 ^{17,18} 1820-16 ¹⁷	7954-16 ¹⁶	947-16 ² 26082-16 ²	735-16 722-16	612-16 ⁷⁵	505-16 ²	622-16	4003 ²⁰	12200 12140	4021
98819-16 ⁶	3110KT 6200	1620-16 ^{17,18} 1820-16 ¹⁷	7954-16 ¹⁶	947-16 ² 26082-16 ²	735-16 722-16	612-16 ⁷⁵	505-16 ²	622-16	4003 ²⁰	12200 12140	4021
98819-16 ⁶	3110KT 6200	1620-16 ^{17,18} 1820-16 ¹⁷	7954-16 ¹⁶	947-16 ² 26082-16 ²	735-16 722-16	612-16 ⁷⁵	505-16 ²	622-16	4003 ²⁰	12200 12140	4021
98819-16 ⁶	3110KT 6200	1620-16 ^{17,18} 1820-16 ¹⁷	7954-16 ¹⁶	947-16 ² 26082-16 ²	735-16 722-16	612-16 ⁷⁵	505-16 ²	622-16	4003 ²⁰	12200 12140	4021
98819-16 ⁶	3110KT 6200	1620-16 ^{17,18} 1820-16 ¹⁷	7954-16 ¹⁶	947-16 ² 26082-16 ²	735-16 722-16	612-16 ⁷⁵	505-16 ²	622-16	4003 ²⁰	12200 12140	4021
98819-16 ⁶	3110KT 6200	1620-16 ^{17,18} 1820-16 ¹⁷	7954-16 ¹⁶	947-16 ² 26082-16 ²	735-16 722-16	612-16 ⁷⁵	505-16 ²	622-16	4003 ²⁰	12200 12140	4021
98819-16 ⁶	3110KT 6200	1620-16 ^{17,18} 1820-16 ¹⁷	7954-16 ¹⁶	948-16 ² 26082-16 ²	735-16 722-16	612-16 ⁷⁵	505-16 ²	622-16	4003 ²⁰	12200 12140	4021
98819-16 ⁶	3110KT 6200	1620-16 ^{17,18} 1820-16 ¹⁷	7954-16 ¹⁶	948-16 ² 26082-16 ²	735-16 722-16	612-16 ⁷⁵	505-16 ²	622-16	4003 ²⁰	12200 12140	4021
98819-16 ⁶	3110KT 6200	1620-16 ^{17,18} 1820-16 ¹⁷	7954-16 ¹⁶	948-16 ² 26082-16 ²	735-16 722-16	612-16 ⁷⁵	505-16 ²	622-16	4003 ²⁰	12200 12140	4021
98819-16 ⁶	3110KT 6200	1620-16 ^{17,18} 1820-16 ¹⁷	7954-16 ¹⁶	948-16 ² 26082-16 ²	735-16 722-16	612-16 ⁷⁵	505-16 ²	622-16	4003 ²⁰	12200 12140	4021

²⁰ Tall block engines require Part #4005

⁴⁶ Must use bronze tip fuel pump pushrod when using high pressure or high volume pump

⁷⁵ Most aluminum heads come standard with 11/32" valve stems. Use appropriate valve locks, retainers, and seals.

RED NUMBERS DENOTE PREMIUM OPTION

CHEVROLET 396-454 C.I. 8 CYL. 1967-1996 (CONTINUED)

APPLICATIONS/CAMSHAFTS	VALVE SETTING		RPM OPERATING RANGE	CAM PART #	CAM GRIND #	DURATION				VALVE LIFT		LOBE SEP. ANGLE
	IN.	EX.				IN.	EX.	IN.	EX.	IN.	EX.	
DRAG RACE Mechanical Roller Camshafts (CONTINUED)												
MECHANICAL ROLLER – For 600+c.i. engines. Pro Street. Pontiac heads. Works well with nitrous.	.028	.030	5200 to 8000	11-722-9^{14,46}	328BR-14	328	344	288	304	.810	.782	114°
MECHANICAL ROLLER – 600+c.i. and larger engines with big nitrous oxide.	.022	.024	6000 to 8000	11-729-9^{14,46}	328PR-16	328	356	288	316	.819	.816	116°
MECHANICAL ROLLER – 550-600c.i. Pro Street engines w/ nitrous. More aggressive than Part #11-727-9.	.028	.030	5400 to 8200	11-732-9^{14,46}	324FR-14	324	348	289	308	.867	.782	114°
MECHANICAL ROLLER – Pro Stock, 600+c.i. with manual transmission, light car.	.022	.024	7000 to 9000	11-728-9^{14,46}	324PR-14	324	352	289	312	.867	.816	114°
DRAG RACE Mechanical Roller Camshafts												
Xtreme RX Rollers use COMP RX Drag roller profiles to give more lift, more area under the curve and shorter seat timing than any other high RPM drag racing series we have offered. Great for all out drag racing.												
MECHANICAL ROLLER – Lower RPM bracket with good heads.	.026	.028	4300 to 8000	11-735-9^{14,46}	310RXD-14	310	330	277	292	.800	.800	114°
MECHANICAL ROLLER – Small Comp Eliminator with high ratio rockers and Fast Bracket, 1.8 and 1.7.	.024	.026	4800 to 8500	11-737-9^{14,46}	314RXD-14	314	334	281	296	.873	.800	114°
MECHANICAL ROLLER – Large Comp Eliminator with high ratio rockers and Fast Bracket, 1.8 and 1.7.	.024	.026	5000 to 9000	11-739-9^{14,46}	318RXD-14	318	338	285	300	.873	.800	114°
MECHANICAL ROLLER – Large cubic inch and nitrous applications.	.024	.026	5000 to 9000	11-741-9^{14,46}	314RXH-15	314	338	281	300	.839	.800	115°
MECHANICAL ROLLER – Very large cubic inch and nitrous applications.	.024	.026	5200 to 9200	11-742-9^{14,46}	318RXH-16	318	352	285	312	.846	.810	116°
MECHANICAL ROLLER – Pro Mod and Mountain motor applications.	.024	.026	4800 to 8500	11-743-9^{14,46}	322RXH-18	322	360	292	320	.878	.867	118°
DRAG RACE 4 & 7 SWAP FIRING ORDER Mechanical Roller Camshafts												
18736542 Firing Order												
MECHANICAL ROLLER – Good bracket, good heads, 11:1+ compression, 4500-5000 stall.	.026	.028	4800 to 7400	11-748-14^{14,46}	47S 312R10	312	319	278	280	.714	.680	110°
MECHANICAL ROLLER – Good Super Gas, 11:1+ compression, 4500+ stall, 427-468c.i.	.028	.030	4600 to 7400	11-749-14^{14,46}	47S 313R10	313	322	276	284	.748	.714	110°
MECHANICAL ROLLER – Fast Bracket, good heads, 13:1+ compression., 5000+ stall, small N20.	.026	.028	5000 to 8500	11-747-14^{14,46}	47S 321R12	321	336	284	296	.748	.748	112°
MECHANICAL ROLLER – Lower RPM bracket with good heads.	.026	.028	4300 to 8000	11-750-14^{14,46}	47S 310RXD-14	310	330	277	292	.800	.800	114°
MECHANICAL ROLLER – Quick 16 and Fast Bracket, 1.8 and 1.7.	.024	.026	4800 to 8500	11-751-14^{14,46}	47S 314RXD-14	314	334	281	296	.873	.800	114°
MECHANICAL ROLLER – Large cubic inch Quick 16, Eliminator w/ high ratio rockers & Fast Bracket, 1.8 & 1.7.	.024	.026	5000 to 9000	11-752-14^{14,46}	47S 318RXD-14	318	338	285	300	.824	.800	114°
MECHANICAL ROLLER – Large cubic inch and nitrous applications.	.024	.026	5000 to 9000	11-753-14^{14,46}	47S 314RXH-15	314	338	281	300	.839	.800	115°
MECHANICAL ROLLER – Nitrous and blown race applications.	.024	.026	5200 to 9200	11-754-14^{14,46}	47S 318RXH-16	318	352	285	312	.846	.810	116°
MECHANICAL ROLLER – Pro Mod and Mountain motor applications.	.024	.026	4800 to 8500	11-755-14^{14,46}	47S 322PMR-18	322	360	292	320	.878	.867	118°

² Requires machining on cylinder heads

⁶ Offset lifters available

¹⁴ Requires upgraded gear, thrust button & wear plate

¹⁶ Truck engines have .400" taller block

¹⁷ Mark V & Mark VI heads must use kit w/ studs

¹⁸ 50-State legal for 1993 & earlier BB Chevrolet V8, 396-454c.i. C.A.R.B. E.O. #D-279-4

²⁰ Tall block engines require Part #4005

CHEVROLET 396-454 C.I. 8 CYL. 1967-1996 (CONTINUED)

CAMSHAFTS GENERAL MOTORS

LIFTERS	TIMING SET	ROCKER ARMS	PUSHRODS	VALVE SPRINGS	RETAINERS	VALVE LOCKS	VALVE SEALS	LASH CAPS	REV KIT	DIST. GEAR	STUD GIRDLES	
DRAG RACE Mechanical Roller Camshafts (CONTINUED)												
98819-16 ⁶	3110KT 6200	1620-16 ^{17,18} 1820-16 ¹⁷	7954-16 ¹⁶	948-16 ² 26082-16 ²	735-16 722-16	612-16 ⁷⁵	505-16 ²	622-16	4003 ²⁰	12200 12140	4021	
98819-16 ⁶	3110KT 6200	1620-16 ^{17,18} 1820-16 ¹⁷	7954-16 ¹⁶	948-16 ² 26082-16 ²	735-16 722-16	612-16 ⁷⁵	505-16 ²	622-16	4003 ²⁰	12200 12140	4021	
98819-16 ⁶	3110KT 6200	1620-16 ^{17,18} 1820-16 ¹⁷	7954-16 ¹⁶	26082-16 ² 26082-16 ²	735-16 722-16	612-16 ⁷⁵	505-16 ²	622-16	4003 ²⁰	12200 12140	4021	
98819-16 ⁶	3110KT 6200	1620-16 ^{17,18} 1820-16 ¹⁷	7954-16 ¹⁶	26082-16 ² 26082-16 ²	735-16 722-16	612-16 ⁷⁵	505-16 ²	622-16	4003 ²⁰	12200 12140	4021	
DRAG RACE Mechanical Roller Camshafts												
98819-16 ⁶	3110KT 6200	1620-16 ^{17,18} 1820-16 ¹⁷	7954-16 ¹⁶	948-16 ² 26082-16 ²	735-16 722-16	612-16 ⁷⁵	505-16 ²	622-16	4003 ²⁰	12200 12140	4021	
98819-16 ⁶	3110KT 6200	1620-16 ^{17,18} 1820-16 ¹⁷	7954-16 ¹⁶	26082-16 ² 26082-16 ²	735-16 722-16	612-16 ⁷⁵	505-16 ²	622-16	4003 ²⁰	12200 12140	4021	
98819-16 ⁶	3110KT 6200	1620-16 ^{17,18} 1820-16 ¹⁷	7954-16 ¹⁶	26082-16 ² 26028-16 ²	735-16 722-16	612-16 ⁷⁵	505-16 ²	622-16	4003 ²⁰	12200 12140	4021	
98819-16 ⁶	3110KT 6200	1620-16 ^{17,18} 1820-16 ¹⁷	7954-16 ¹⁶	26082-16 ² 26028-16 ²	735-16 722-16	612-16 ⁷⁵	505-16 ²	622-16	4003 ²⁰	12200 12140	4021	
98819-16 ⁶	3110KT 6200	1620-16 ^{17,18} 1820-16 ¹⁷	7954-16 ¹⁶	26082-16 ² 26028-16 ²	735-16 722-16	612-16 ⁷⁵	505-16 ²	622-16	4003 ²⁰	12200 12140	4021	
98819-16 ⁶	3110KT 6200	1620-16 ^{17,18} 1820-16 ¹⁷	7954-16 ¹⁶	26082-16 ² 26028-16 ²	735-16 722-16	612-16 ⁷⁵	505-16 ²	622-16	4003 ²⁰	12200 12140	4021	
DRAG RACE 4 & 7 SWAP FIRING ORDER Mechanical Roller Camshafts												
819-16 ⁶ 98819-16 ⁶	3110KT 6200	1620-16 ^{17,18} 1820-16 ¹⁷	7954-16 ¹⁶	948-16 ² 26028-16 ²	735-16 722-16	612-16 ⁷⁵	505-16 ²	622-16	4003 ²⁰	12200 12140	4021	
98819-16 ⁶	3110KT 6200	1620-16 ^{17,18} 1820-16 ¹⁷	7954-16 ¹⁶	948-16 ² 26028-16 ²	735-16 722-16	612-16 ⁷⁵	505-16 ²	622-16	4003 ²⁰	12200 12140	4021	
98819-16 ⁶	3110KT 6200	1620-16 ^{17,18} 1820-16 ¹⁷	7954-16 ¹⁶	948-16 ² 26028-16 ²	735-16 722-16	612-16 ⁷⁵	505-16 ²	622-16	4003 ²⁰	12200 12140	4021	
98819-16 ⁶	3110KT 6200	1620-16 ^{17,18} 1820-16 ¹⁷	7954-16 ¹⁶	948-16 ² 26028-16 ²	735-16 722-16	612-16 ⁷⁵	505-16 ²	622-16	4003 ²⁰	12200 12140	4021	
98819-16 ⁶	3110KT 6200	1620-16 ^{17,18} 1820-16 ¹⁷	7954-16 ¹⁶	26082-16 ² 26028-16 ²	735-16 722-16	612-16 ⁷⁵	505-16 ²	622-16	4003 ²⁰	12200 12140	4021	
98819-16 ⁶	3110KT 6200	1620-16 ^{17,18} 1820-16 ¹⁷	7954-16 ¹⁶	26082-16 ² 26028-16 ²	735-16 722-16	612-16 ⁷⁵	505-16 ²	622-16	4003 ²⁰	12200 12140	4021	
98819-16 ⁶	3110KT 6200	1620-16 ^{17,18} 1820-16 ¹⁷	7954-16 ¹⁶	26082-16 ² 26028-16 ²	735-16 722-16	612-16 ⁷⁵	505-16 ²	622-16	4003 ²⁰	12200 12140	4021	
98819-16 ⁶	3110KT 6200	1620-16 ^{17,18} 1820-16 ¹⁷	7954-16 ¹⁶	26082-16 ² 26028-16 ²	735-16 722-16	612-16 ⁷⁵	505-16 ²	622-16	4003 ²⁰	12200 12140	4021	

⁴⁶ Must use bronze tip fuel pump pushrod when using high pressure or high volume pump

⁷⁵ Most aluminum heads come standard with 11/32" valve stems. Use appropriate valve locks, retainers, and seals.

RED NUMBERS DENOTE PREMIUM OPTION

CHEVROLET 396-454 C.I. 8 CYL. 1967-1996 (CONTINUED)

APPLICATIONS/CAMSHAFTS	VALVE SETTING		RPM OPERATING RANGE	CAM PART #	CAM GRIND #	DURATION				VALVE LIFT		LOBE SEP. ANGLE
	IN.	EX.				ADVERTISED IN.	EX.	@ .050" IN.	EX.	W/ 1.7 ROCKER IN.	EX.	
OVAL TRACK Mechanical Roller Camshafts												
MECHANICAL ROLLER – Best cam for short track engines. 1/4 to 3/8 mile.	.022	.024	3200 to 6200	11-700-9 ^{14, 46}	288AR-8	288	296	251	260	.680	.680	108°
MECHANICAL ROLLER – Best for 3/8 to 1/2 mile with 468c.i. motor. Broad torque curve.	.022	.024	3500 to 6500	11-701-9 ^{14, 46}	296AR-8	296	306	260	270	.680	.680	108°
MECHANICAL ROLLER – 3/8 to 5/8 mile high bank track. Works best in large engine.	.022	.024	3800 to 6800	11-704-9 ^{14, 46}	300BR-8	300	308	266	274	.714	.714	108°
OVAL TRACK Mechanical Roller Camshafts												
Note: Xtreme RX Rollers use COMP's RX intake and RZ exhaust profiles to provide the ultimate in high RPM power and durability. (Custom Grinds Available)												
MECHANICAL ROLLER – 427-454c.i. Good torque for short tracks with tight turns.	.020	.022	3200 to 6200	11-850-9 ^{14, 46}	286RX-8	286	293	253	260	.727	.729	108°
MECHANICAL ROLLER – 468c.i. Broad power for mid-size tracks. Easy on parts.	.020	.022	3600 to 6600	11-851-9 ^{14, 46}	294RX-8	294	303	261	270	.734	.737	108°
MECHANICAL ROLLER – 468-500c.i. For larger tracks with wide turns.	.020	.022	4000 to 7000	11-852-9 ^{14, 46}	300RX-10	300	309	267	276	.739	.742	110°

CHEVROLET GEN VI 454 & 502 C.I. 8 CYL. 1996-1999

APPLICATIONS/CAMSHAFTS	VALVE SETTING		RPM OPERATING RANGE	CAM PART #	CAM GRIND #	DURATION				VALVE LIFT		LOBE SEP. ANGLE
	IN.	EX.				ADVERTISED IN.	EX.	@ .050" IN.	EX.	W/ 1.7 ROCKER IN.	EX.	
XTREME ENERGY™ Hydraulic Roller Camshafts												
HYDRAULIC ROLLER – Very strong low speed torque with excellent mileage.	Hyd.	Hyd.	600 to 4600	01-405-8 ^{37, 46}	XR252HR	252	258	200	206	.510	.510	110°
HYDRAULIC ROLLER – Great low end torque, good for towing or in RV. Works w/ stock intake & exhaust.	Hyd.	Hyd.	1000 to 5000	01-409-8 ^{37, 46}	XR258HR	258	264	206	212	.510	.510	110°
HYDRAULIC ROLLER – Mild performance driving w/ good low end & great mid-range power. Good mileage.	Hyd.	Hyd.	1200 to 5200	01-411-8 ^{37, 46}	XR264HR	264	270	212	218	.510	.510	110°
HYDRAULIC ROLLER – Best in performance applications with great mid-range power. Likes headers.	Hyd.	Hyd.	1600 to 5400	01-414-8 ^{37, 46}	XR270HR	270	276	218	224	.510	.510	110°
HYDRAULIC ROLLER – Great for high perf. street, needs intake, headers, lower gears & 2000+ stall.	Hyd.	Hyd.	1900 to 5600	01-416-8 ^{37, 46}	XR276HR	276	282	224	230	.510	.510	110°
HYDRAULIC ROLLER – For high performance street engines, needs 2500+ stall, improved intake manifold, headers and lower gears.	Hyd.	Hyd.	2200 to 5800	01-418-8 ^{37, 46}	XR282HR	282	288	230	236	.510	.510	110°
HYDRAULIC ROLLER – Street/strip applications with 10:1+ compression and 2800+ stall. Rough idle, needs good intake and headers.	Hyd.	Hyd.	2500 to 6000	01-421-8 ^{37, 46}	XR288HR	288	294	236	242	.521	.540	110°
HYDRAULIC ROLLER – Best for serious street/ strip use with 10.5:1+ compression and 3000+ stall. Needs good intake, headers and ported heads.	Hyd.	Hyd.	2800 to 6200	01-424-8 ^{37, 46}	XR294HR	294	300	242	248	.540	.560	110°
HYDRAULIC ROLLER – Good for Pro Street and bracket racing. Needs 10.5:1+compression, 3500+ stall, very good intake, headers with low gears.	Hyd.	Hyd.	3000 to 6400	01-425-8 ^{37, 46}	XR300HR	300	306	248	254	.560	.580	110°
HYDRAULIC ROLLER – Works well with nitrous & blow-er applications. Needs 3000+ stall & all upgraded parts.	Hyd.	Hyd.	2800 to 6400	01-426-8 ^{37, 46}	XR294HR-14	294	300	242	248	.540	.560	114°
HYDRAULIC ROLLER – Works well with large c.i. engines. Great for bracket racing, with all upgraded parts, needs 3500+ stall.	Hyd.	Hyd.	3000 to 6600	01-427-8 ^{37, 46}	XR300HR-14	300	306	248	254	.560	.580	114°

² Requires machining on cylinder heads

⁶ Offset lifters available

⁷ Stock springs cannot be used

¹⁴ Requires upgraded gear, thrust button & wear plate

¹⁶ Truck engines have .400" taller block

¹⁷ Mark V & Mark VI heads must use kit w/ studs

¹⁸ 50-State legal for 1993 & earlier BB Chevrolet V8, 396-454c.i. C.A.R.B. E.O. #D-279-4

²⁰ Tall block engines require Part #4005

³⁷ Adjustable valve train required

⁴⁶ Must use bronze tip fuel pump pushrod when using high pressure or high volume pump

CHEVROLET 396-454 C.I. 8 CYL. 1967-1996 (CONTINUED)

LIFTERS	TIMING SET	ROCKER ARMS	PUSHRODS	VALVE SPRINGS	RETAINERS	VALVE LOCKS	VALVE SEALS	LASH CAPS	REV KIT	DIST. GEAR	STUD GIRDLES
OVAL TRACK Mechanical Roller Camshafts											
819-16 ⁶ 98819-16 ⁶	3110KT 6200	1620-16 ^{17,18} 1820-16 ¹⁷	7954-16 ¹⁶	944-16 ² 26091-16 ²	731-16 784-16	612-16 ⁷⁵	505-16 ²	622-16	4003 ²⁰	12200 12140	4021
819-16 ⁶ 98819-16 ⁶	3110KT 6200	1620-16 ^{17,18} 1820-16 ¹⁷	7954-16 ¹⁶	944-16 ² 26091-16 ²	731-16 784-16	612-16 ⁷⁵	505-16 ²	622-16	4003 ²⁰	12200 12140	4021
819-16 ⁶ 98819-16 ⁶	3110KT 6200	1620-16 ^{17,18} 1820-16 ¹⁷	7954-16 ¹⁶	944-16 ² 26091-16 ²	731-16 784-16	612-16 ⁷⁵	505-16 ²	622-16	4003 ²⁰	12200 12140	4021
OVAL TRACK Mechanical Roller Camshafts											
98819-16 ⁶	3110KT 6200	1620-16 ^{17,18} 1820-16 ¹⁷	7954-16 ¹⁶	26099-16 ²	733-16	612-16 ⁷⁵	505-16 ²	622-16	4003 ²⁰	12200 12140	4021
98819-16 ⁶	3110KT 6200	1620-16 ^{17,18} 1820-16 ¹⁷	7954-16 ¹⁶	26099-16 ²	733-16	612-16 ⁷⁵	505-16 ²	622-16	4003 ²⁰	12200 12140	4021
98819-16 ⁶	3110KT 6200	1620-16 ^{17,18} 1820-16 ¹⁷	7954-16 ¹⁶	26099-16 ²	733-16	612-16 ⁷⁵	505-16 ²	622-16	4003 ²⁰	12200 12140	4021

CHEVROLET GEN VI 454 & 502 C.I. 8 CYL. 1996-1999

K-KIT	SK-KIT	CL-KIT	RP-KIT	LIFTERS	TIMING SET	ROCKER ARMS	PUSHRODS	VALVE SPRINGS	RETAINERS	VALVE LOCKS	VALVE SEALS
XTREME ENERGY™ Hydraulic Roller Camshafts											
K01-405-8 ⁵⁷	SK01-405-8 ^{7,37}	CL01-405-8 ^{7,37}	RPS302	900-16	3149KT	1411-16 ⁵⁸ 1620-16 ⁵⁸	7815-16	911-16 924-16 ²	748-16 741-16	612-16 ⁷⁵	504-16 505-16 ²
K01-409-8 ⁵⁷	SK01-409-8 ^{7,37}	CL01-409-8 ^{7,37}	RPS302	900-16	3149KT	1411-16 ⁵⁸ 1620-16 ⁵⁸	7815-16	911-16 924-16 ²	748-16 741-16	612-16 ⁷⁵	504-16 505-16 ²
K01-411-8 ⁵⁷	SK01-411-8 ^{7,37}	CL01-411-8 ^{7,37}	RPS302	900-16	3149KT	1411-16 ⁵⁸ 1620-16 ⁵⁸	7815-16	911-16 924-16 ²	748-16 741-16	612-16 ⁷⁵	504-16 505-16 ²
K01-414-8 ⁵⁷	SK01-414-8 ^{7,37}	CL01-414-8 ^{7,37}	RPS302	900-16	3149KT	1411-16 ⁵⁸ 1620-16 ⁵⁸	7815-16	911-16 924-16 ²	748-16 741-16	612-16 ⁷⁵	504-16 505-16 ²
K01-416-8 ⁵⁷	SK01-416-8 ^{7,37}	CL01-416-8 ^{7,37}	RPS302	900-16	3149KT	1411-16 ⁵⁸ 1620-16 ⁵⁸	7815-16	911-16 924-16 ²	748-16 741-16	612-16 ⁷⁵	504-16 505-16 ²
K01-418-8 ⁵⁷	SK01-418-8 ^{7,37}	CL01-418-8 ^{7,37}	RPS302	900-16	3149KT	1411-16 ⁵⁸ 1620-16 ⁵⁸	7815-16	911-16 924-16 ²	748-16 741-16	612-16 ⁷⁵	504-16 505-16 ²
K01-421-8 ⁵⁷	SK01-421-8 ^{7,37}	CL01-421-8 ^{7,37}	RPS302	900-16	3149KT	1411-16 ⁵⁸ 1620-16 ⁵⁸	7815-16	924-16 ² 26120-16	741-16 795-16	612-16 ⁷⁵ 616-16 ²	505-16 ²
K01-424-8 ⁵⁷	SK01-424-8 ^{7,37}	CL01-424-8 ^{7,37}	RPS302	900-16	3149KT	1411-16 ⁵⁸ 1620-16 ⁵⁸	7815-16	924-16 ² 26120-16	741-16 795-16	612-16 ⁷⁵ 616-16 ²	505-16 ²
K01-425-8 ⁵⁷	SK01-425-8 ^{7,37}	CL01-425-8 ^{7,37}	RPS302	900-16	3149KT	1411-16 ⁵⁸ 1620-16 ⁵⁸	7815-16	924-16 ² 26120-16	741-16 795-16	612-16 ⁷⁵ 616-16 ²	505-16 ²
K01-426-8 ⁵⁷	SK01-426-8 ^{7,37}	CL01-426-8 ^{7,37}	RPS302	900-16	3149KT	1411-16 ⁵⁸ 1620-16 ⁵⁸	7815-16	924-16 ² 26120-16	741-16 795-16	612-16 ⁷⁵ 616-16 ²	505-16 ²
K01-427-8 ⁵⁷	SK01-427-8 ^{7,37}	CL01-427-8 ^{7,37}	RPS302	900-16	3149KT	1411-16 ⁵⁸ 1620-16 ⁵⁸	7815-16	924-16 ² 26120-16	741-16 795-16	612-16 ⁷⁵ 616-16 ²	505-16 ²

⁵⁷ K-Kit includes Part #4514-KIT rocker arm adjusting kit and pushrods
⁵⁸ Requires Part #4514-KIT, except on factory aluminum heads

⁷⁵ Most aluminum heads come standard with 11/32" valve stems. Use appropriate valve locks, retainers, and seals.

RED NUMBERS DENOTE PREMIUM OPTION

CHEVROLET GEN VI 454 & 502 C.I. 8 CYL. 1996-1999 (CONTINUED)

APPLICATIONS/CAMSHAFTS	VALVE SETTING		RPM OPERATING RANGE	CAM PART #	CAM GRIND #	DURATION				VALVE LIFT		LOBE SEP. ANGLE
	IN.	EX.				ADVERTISED IN.	EX.	@ .050" IN.	EX.	W/ 1.7 ROCKER IN.	EX.	
XTREME ENERGY™ Computer Controlled Hydraulic Roller Camshafts												
HYDRAULIC ROLLER – Good replacement cam for minimally modified fuel injection engines.	Hyd.	Hyd.	800 to 4800	01-410-8 ^{37,46}	XR258HR-13	258	267	206	212	.510	.510	113°
HYDRAULIC ROLLER – Very good low RPM torque. Great for towing applications, works with fuel injection.	Hyd.	Hyd.	1200 to 5200	01-412-8 ^{37,46}	XR264HR-13	264	270	212	218	.510	.510	113°
HYDRAULIC ROLLER – Great mid-range power, likes headers, needs custom tuning.	Hyd.	Hyd.	1500 to 5500	01-415-8 ^{37,46}	XR270HR-13	270	276	218	224	.510	.510	113°
HYDRAULIC ROLLER – Great in performance applications w/ custom tuning and 2200+ stall converter.	Hyd.	Hyd.	1800 to 5800	01-417-8 ^{37,46}	XR276HR-13	276	282	224	230	.510	.510	113°
HYDRAULIC ROLLER – Works well with ported heads, serious valve train upgrade required, needs 2200+ stall and programmer.	Hyd.	Hyd.	1800 to 6000	01-775-8 ^{37,46}	XR271HR-12	271	279	224	232	.591	.601	112°
HYDRAULIC ROLLER – Best in high performance street engines, needs intake, headers, 2400+ stall converter and programmer.	Hyd.	Hyd.	2000 to 6000	01-419-8 ^{37,46}	XR282HR-14	282	288	230	236	.510	.520	114°
HYDRAULIC ROLLER – Best in high performance street and race engines. Needs intake, headers, lower gear, 2600+ stall and programmer.	Hyd.	Hyd.	2200 to 6200	01-422-8 ^{37,46}	XR288HR-14	288	294	236	242	.520	.539	114°
THUMPR™ Hydraulic Roller Camshafts												
HYDRAULIC ROLLER – Thumpr™-High performance street, stock converter ok, best with 2000+ converter and gears, choppy/thumping idle.	Hyd.	Hyd.	1900 to 5600	01-600-8 ³⁷	283THR7	283	303	227	241	.547	.530	107°
HYDRAULIC ROLLER – Mutha' Thumpr™-High performance street/strip, needs 9:1 compression, 2500+ stall, intake, gears and headers, rough idle.	Hyd.	Hyd.	2200 to 5900	01-601-8 ³⁷	291THR7	291	311	235	249	.557	.542	107°
HYDRAULIC ROLLER – Big Mutha' Thumpr™-Street/strip, needs 9.5:1 compression, 2800+ stall, intake, gears and headers, very rough idle.	Hyd.	Hyd.	2500 to 6200	01-602-8 ³⁷	299THR7	299	319	243	257	.569	.554	107°
XTREME MARINE™ Hydraulic Roller Camshafts												
HYDRAULIC ROLLER – Good for inboard/outboard pleasure boats, has good idle.	Hyd.	Hyd.	1600 to 5400	01-445-8 ^{37,46}	XM270HR	270	276	218	224	.510	.510	112°
HYDRAULIC ROLLER – Good for jet boat with A impeller. Great for pleasure or mild performance use.	Hyd.	Hyd.	2200 to 5800	01-451-8 ^{37,46}	XM284HR	284	290	230	236	.547	.547	112°
HYDRAULIC ROLLER – Good for jet boat with A or B impeller in bracket racing or performance use.	Hyd.	Hyd.	2800 to 6200	01-456-8 ^{37,46}	XM296HR	296	302	242	248	.566	.566	112°
HYDRAULIC ROLLER – Good in jet boat with B impeller, 10:1+ compression, running river drags or bracket racing.	Hyd.	Hyd.	3500 to 6500	01-461-8 ^{37,46}	XM308HR	308	314	254	260	.575	.575	112°
XTREME MARINE EFI Hydraulic Roller Camshaft												
HYDRAULIC ROLLER - EFI Marine cam for 525c.i.. Steel billet cam with cast distributor gear.	Hyd.	Hyd.	2500-6000	01-446-11 ^{37,46}	XM289HR-14	289	297	235	243	.610	.627	114°

² Requires machining on cylinder heads⁷ Stock springs cannot be used³⁷ Adjustable valve train required⁴⁶ Must use bronze tip fuel pump pushrod when using high pressure or high volume pump⁵⁷ K-Kit includes Part #4514-KIT rocker arm adjusting kit and pushrods

CHEVROLET GEN VI 454 & 502 C.I. 8 CYL. 1996-1999 (CONTINUED)

CAMSHAFTS
GENERAL MOTORS

K-KIT	SK-KIT	CL-KIT	RP-KIT	LIFTERS	TIMING SET	ROCKER ARMS	PUSHRODS	VALVE SPRINGS	RETAINERS	VALVE LOCKS	VALVE SEALS
XTREME ENERGY™ Computer Controlled Hydraulic Roller Camshafts											
K01-410-8 ⁵⁷	SK01-410-8 ^{7,37}	CL01-410-8 ^{7,37}	RPS302	900-16	3149KT	1411-16 ⁵⁸ 1620-16 ⁵⁸	7815-16	911-16 924-16 ²	748-16 741-16	612-16 ⁷⁵	504-16 505-16 ²
K01-412-8 ⁵⁷	SK01-412-8 ^{7,37}	CL01-412-8 ^{7,37}	RPS302	900-16	3149KT	1411-16 ⁵⁸ 1620-16 ⁵⁸	7815-16	911-16 924-16 ²	748-16 741-16	612-16 ⁷⁵	504-16 505-16 ²
K01-415-8 ⁵⁷	SK01-415-8 ^{7,37}	CL01-415-8 ^{7,37}	RPS302	900-16	3149KT	1411-16 ⁵⁸ 1620-16 ⁵⁸	7815-16	911-16 924-16 ²	748-16 741-16	612-16 ⁷⁵	504-16 505-16 ²
K01-417-8 ⁵⁷	SK01-417-8 ^{7,37}	CL01-417-8 ^{7,37}	RPS302	900-16	3149KT	1411-16 ⁵⁸ 1620-16 ⁵⁸	7815-16	911-16 924-16 ²	748-16 741-16	612-16 ⁷⁵	504-16 505-16 ²
K01-775-8 ⁵⁷	SK01-775-8 ^{7,37}	CL01-775-8 ^{7,37}	RPS302	900-16	3149KT	1411-16 ⁵⁸ 1620-16 ⁵⁸	7815-16	924-16 ² 26120-16	741-16 795-16	612-16 ⁷⁵ 616-16 ²	505-16 ²
K01-419-8 ⁵⁷	SK01-419-8 ^{7,37}	CL01-419-8 ^{7,37}	RPS302	900-16	3149KT	1411-16 ⁵⁸ 1620-16 ⁵⁸	7815-16	911-16 924-16 ²	748-16 741-16	612-16 ⁷⁵	504-16 505-16 ²
K01-422-8 ⁵⁷	SK01-422-8 ^{7,37}	CL01-422-8 ^{7,37}	RPS302	900-16	3149KT	1411-16 ⁵⁸ 1620-16 ⁵⁸	7815-16	924-16 ² 26120-16	741-16 795-16	612-16 ⁷⁵ 616-16 ²	505-16 ²
THUMPR™ Hydraulic Roller Camshafts											
K01-600-8 ⁵⁷	N/A	CL01-600-8 ^{7,37}	RPS302	900-16	3149KT	1411-16 ⁵⁸ 1620-16 ⁵⁸	7815-16	924-16 ² 26120-16	741-16 795-16	612-16 ⁷⁵ 616-16 ²	505-16 ²
K01-601-8 ⁵⁷	N/A	CL01-601-8 ^{7,37}	RPS302	900-16	3149KT	1411-16 ⁵⁸ 1620-16 ⁵⁸	7815-16	924-16 ² 26120-16	741-16 795-16	612-16 ⁷⁵ 616-16 ²	505-16 ²
K01-602-8 ⁵⁷	N/A	CL01-602-8 ^{7,37}	RPS302	900-16	3149KT	1411-16 ⁵⁸ 1620-16 ⁵⁸	7815-16	924-16 ² 26120-16	741-16 795-16	612-16 ⁷⁵ 616-16 ²	505-16 ²
XTREME MARINE™ Hydraulic Roller Camshafts											
K01-445-8 ⁵⁷	SK01-445-8 ^{7,37}	CL01-445-8 ^{7,37}	RPS302	900-16	3149KT	1411-16 ⁵⁸ 1620-16 ⁵⁸	7815-16	911-16 924-16 ²	748-16 741-16	612-16 ⁷⁵	504-16 505-16 ²
K01-451-8 ⁵⁷	SK01-451-8 ^{7,37}	CL01-451-8 ^{7,37}	RPS302	900-16	3149KT	1411-16 ⁵⁸ 1620-16 ⁵⁸	7815-16	924-16 ² 26120-16	741-16 795-16	612-16 ⁷⁵ 616-16 ²	505-16 ²
K01-456-8 ⁵⁷	SK01-456-8 ^{7,37}	CL01-456-8 ^{7,37}	RPS302	900-16	3149KT	1411-16 ⁵⁸ 1620-16 ⁵⁸	7815-16	924-16 ² 26120-16	741-16 795-16	612-16 ⁷⁵ 616-16 ²	505-16 ²
K01-461-8 ⁵⁷	SK01-461-8 ^{7,37}	CL01-461-8 ^{7,37}	RPS302	900-16	3149KT	1411-16 ⁵⁸ 1620-16 ⁵⁸	7815-16	924-16 ² 26120-16	741-16 795-16	612-16 ⁷⁵ 616-16	505-16 ²
LIFTERS	TIMING SET	ROCKER ARMS	PUSHRODS	VALVE SPRINGS	RETAINERS	VALVE LOCKS	VALVE SEALS	LASH CAPS	REV KIT	DIST. GEAR	STUD GIRDLES
XTREME MARINE EFI Hydraulic Roller Camshaft											
900-16	3149KT	1620-16 ⁵⁸ 1820-16 ⁵⁸	7663-16 7998-16	928-16	741-16 1731-16	612-16	505-16	622-16	N/A	412M	N/A

⁵⁸ Requires Part #4514-KIT, except on factory aluminum heads

⁷⁵ Most aluminum heads come standard with 11/32" valve stems. Use appropriate valve locks, retainers, and seals.

RED NUMBERS DENOTE PREMIUM OPTION

CHEVROLET GEN VI 454 & 502 C.I. 8 CYL. 1996-1999 (CONTINUED)

APPLICATIONS/CAMSHAFTS	VALVE SETTING		RPM OPERATING RANGE	CAM PART #	CAM GRIND #	DURATION				VALVE LIFT		LOBE SEP. ANGLE
	IN.	EX.				ADVERTISED IN.	EX.	@ .050" IN.	EX.	W/ 1.7 ROCKER IN.	EX.	
TRI-POWER XTREME™ Hydraulic Roller Camshafts												
HYDRAULIC ROLLER – Optimized fuel mileage with good torque and hp.	Hyd.	Hyd.	600 to 4600	01-525-8⁴⁶	TPX246HR-16	246	258	194	206	.500	.493	116°
HYDRAULIC ROLLER – Exceptional torque with good hp and moderate fuel economy.	Hyd.	Hyd.	800 to 4800	01-530-8⁴⁶	TPX254HR-15	254	264	202	212	.507	.500	115°
HYDRAULIC ROLLER – Optimized horsepower with good torque and average fuel economy.	Hyd.	Hyd.	1200 to 5200	01-535-8⁴⁶	TPX262HR-14	262	270	210	218	.513	.507	114°
DRAG RACE Mechanical Roller Camshafts												
MECHANICAL ROLLER – Great in Super Street when using a heavy car, very good power band.	.024	.026	3500 to 6800	01-712-9^{37,46}	296ER-8	296	304	260	268	.714	.714	108°
MECHANICAL ROLLER – Good for Super Street or Super Gas with 4500+ stall.	.024	.026	4500 to 7300	01-708-9^{37,46}	312AR-10	312	319	276	280	.714	.680	110°
MECHANICAL ROLLER – Best in Super Comp or Super Gas with 5000+ stall.	.024	.026	5000 to 7800	01-710-9^{37,46}	322CR-10	322	330	282	292	.727	.714	110°

GM 8100/8.1L 8 CYL. 2001-PRESENT

APPLICATIONS/CAMSHAFTS	VALVE SETTING		RPM OPERATING RANGE	CAM PART #	CAM GRIND #	DURATION				VALVE LIFT		LOBE SEP. ANGLE
	IN.	EX.				ADVERTISED IN.	EX.	@ .050" IN.	EX.	W/ 1.7 ROCKER IN.	EX.	
XTREME ENERGY™ Hydraulic Roller Camshafts												
HYDRAULIC ROLLER – Great torque, good for towing and RVs. Works with OE intake and exhaust.	Hyd.	Hyd.	800 to 4800	46-408-9^{37,46}	XR258HR	258	264	206	212	.510	.510	112°
HYDRAULIC ROLLER – Good mid-range performance, great daily driver, headers recommended.	Hyd.	Hyd.	1000 to 5000	46-413-9^{37,46}	XR264HR	264	270	212	218	.510	.510	114°
HYDRAULIC ROLLER – Best in performance applications, aftermarket intake and exhaust recommended.	Hyd.	Hyd.	1200 to 5200	46-422-9^{37,46}	XR270HR	270	276	218	224	.510	.510	114°
TRI-POWER XTREME™ Hydraulic Roller Camshafts												
HYDRAULIC ROLLER – Optimized fuel mileage with good torque and HP.	Hyd.	Hyd.	600 to 4600	46-525-9⁴⁶	TPX246HR-16	246	258	194	206	.500	.493	116°
HYDRAULIC ROLLER – Exceptional torque with good hp and moderate fuel economy.	Hyd.	Hyd.	800 to 4800	46-530-9⁴⁶	TPX254HR-15	254	264	202	212	.507	.500	115°
HYDRAULIC ROLLER – Optimized horsepower with good torque and average fuel economy.	Hyd.	Hyd.	1000 to 5000	46-535-9⁴⁶	TPX262HR-14	262	270	210	218	.513	.507	114°

GM 6600/6.6L DURAMAX DIESEL 2000-PRESENT

APPLICATIONS/CAMSHAFTS	VALVE SETTING		RPM OPERATING RANGE	CAM PART #	CAM GRIND #	DURATION				VALVE LIFT		LOBE SEP. ANGLE
	IN.	EX.				ADVERTISED IN.	EX.	@ .050" IN.	EX.	W/ 1.37/1.69 ROCKER IN.	EX.	
TRI-POWER XTREME™ Mechanical Roller Camshafts												
MECHANICAL ROLLER – Perfect for mild modifications, optimized fuel mileage and improved torque/hp. Good for heavy towing.	.010	.010	1200 to 3800	132-500-12	246XD R108	246	254	185	188	.420	.420	108°
MECHANICAL ROLLER – Designed for modified performance applications (Exh., programmer, etc.). Good for limited towing.	.010	.010	1500 to 4200	132-501-12	258XD R109	258	268	197	202	.450	.450	109°
MECHANICAL ROLLER – Optimized HP for heavily modified, street/strip, non-towing, high RPM applications.	.010	.010	1800 to 4600	132-502-12	270XD R109	270	282	209	216	.480	.480	109°

² Requires machining on cylinder heads
³⁷ Adjustable valve train required

⁴⁶ Must use bronze tip fuel pump pushrod when using high pressure or high volume pump

⁵⁸ Requires Part #4514-KIT, except on factory aluminum heads

CHEVROLET GEN VI 454 & 502 C.I. 8 CYL. 1996-1999 (CONTINUED)

CAMSHAFTS GENERAL MOTORS

LIFTERS	TIMING SET	ROCKER ARMS	PUSHRODS	VALVE SPRINGS	RETAINERS	VALVE LOCKS	VALVE SEALS	LASH CAPS	REV KIT	DIST. GEAR	STUD GIRDLES	
TRI-POWER XTREME™ Hydraulic Roller Camshafts												
900-16	3149KT	1620-16 ⁵⁸ 1620-16 ⁵⁸	7815-16	911-16 26120-16	748-16 795-16	612-16 ⁷⁵ 616-16 ⁷⁵	504-16 505-16 ²	622-16	N/A	412M	4021	
900-16	3149KT	1411-16 ⁵⁸ 1620-16 ⁵⁸	7815-16	911-16 26120-16	748-16 795-16	612-16 ⁷⁵ 616-16 ⁷⁵	504-16 505-16 ²	622-16	N/A	412M	4021	
900-16	3149KT	1411-16 ⁵⁸ 1620-16 ⁵⁸	7815-16	911-16 26120-16	748-16 795-16	612-16 ⁷⁵ 616-16 ⁷⁵	504-16 505-16 ²	622-16	N/A	412M	4021	
DRAG RACE Mechanical Roller Camshafts												
883-16	3149KT	1620-16 ⁵⁸ 1820-16 ⁵⁸	7954-16	947-16 ² 26082-16 ²	735-16 722-16	612-16 ⁷⁵	505-16 ² 506-16 ²	622-16	N/A	12200 12140	4021	
883-16	3149KT	1620-16 ⁵⁸ 1820-16 ⁵⁸	7954-16	947-16 ² 26082-16 ²	735-16 722-16	612-16 ⁷⁵	505-16 ² 506-16 ²	622-16	N/A	12200 12140	4021	
883-16	3149KT	1620-16 ⁵⁸ 1820-16 ⁵⁸	7954-16	947-16 ² 26082-16 ²	735-16 722-16	612-16 ⁷⁵	505-16 ² 506-16 ²	622-16	N/A	12200 12140	4021	

GM 8100/8.1L 8 CYL. 2001-PRESENT

LIFTERS	TIMING SET	ROCKER ARMS	PUSHRODS	VALVE SPRINGS	RETAINERS	VALVE LOCKS	VALVE SEALS	LASH CAPS	REV KIT	DIST. GEAR	STUD GIRDLES	
XTREME ENERGY™ Hydraulic Roller Camshafts												
900-16	N/A	1411-16 ⁵⁸	7815-16	911-16 26120-16	748-16 795-16	612-16 ⁷⁵ 616-16 ⁷⁵	504-16 505-16 ²	N/A	N/A	N/A	N/A	
900-16	N/A	1411-16 ⁵⁸	7815-16	911-16 26120-16	748-16 795-16	612-16 ⁷⁵ 616-16 ⁷⁵	504-16 505-16 ²	N/A	N/A	N/A	N/A	
900-16	N/A	1411-16 ⁵⁸	7815-16	911-16 26120-16	748-16 795-16	612-16 ⁷⁵ 616-16 ⁷⁵	504-16 505-16 ²	N/A	N/A	N/A	N/A	
TRI-POWER XTREME™ Hydraulic Roller Camshafts												
900-16	N/A	1411-16 ⁵⁸	7815-16	911-16 26120-16	748-16 795-16	612-16 ⁷⁵ 616-16 ⁷⁵	504-16 505-16 ²	N/A	N/A	N/A	N/A	
900-16	N/A	1411-16 ⁵⁸	7815-16	911-16 26120-16	748-16 795-16	612-16 ⁷⁵ 616-16 ⁷⁵	504-16 505-16 ²	N/A	N/A	N/A	N/A	
900-16	N/A	1411-16 ⁵⁸	7815-16	911-16 26120-16	748-16 795-16	612-16 ⁷⁵ 616-16 ⁷⁵	504-16 505-16 ²	N/A	N/A	N/A	N/A	

GM 6600/6.6L DURAMAX DIESEL 2000-PRESENT

K-KIT	SK-KIT	CL-KIT	RP-KIT	LIFTERS	TIMING SET	ROCKER ARMS	PUSHRODS	VALVE SPRINGS	RETAINERS	VALVE LOCKS	VALVE SEALS	
TRI-POWER XTREME™ Mechanical Roller Camshafts												
N/A	N/A	N/A	N/A	N/A	N/A	N/A	N/A	26113-32 26125-32	701-32	N/A	N/A	
N/A	N/A	N/A	N/A	N/A	N/A	N/A	N/A	26113-32 26125-32	701-32	N/A	N/A	
N/A	N/A	N/A	N/A	N/A	N/A	N/A	N/A	26113-32 26125-32	701-32	N/A	N/A	

⁷⁵ Most aluminum heads come standard with 11/32" valve stems. Use appropriate valve locks, retainers, and seals.

OLDSMOBILE 260-455 C.I. 8 CYL. 1967-1990

APPLICATIONS/CAMSHAFTS	VALVE SETTING		RPM OPERATING RANGE	CAM PART #	CAM GRIND #	DURATION				VALVE LIFT		LOBE SEP. ANGLE
	IN.	EX.				ADVERTISED IN.	EX.	@ .050" IN.	EX.	W/ 1.6 ROCKER IN.	EX.	
HIGH ENERGY™ Hydraulic Flat Tappet Camshafts												
HYDRAULIC – Ideal for family sedans. Good low end torque and economy, smooth idle.	Hyd.	Hyd.	800 to 4800	42-227-4	252H	252	252	206	206	.433	.433	110°
HYDRAULIC – Excellent power for towing. Good performance with highway gears, smooth idle.	Hyd.	Hyd.	1200 to 5200	42-228-4	260H	260	260	212	212	.447	.447	110°
HYDRAULIC – Performance camshaft for mild street machines. Broad power, noticeable idle.	Hyd.	Hyd.	1500 to 5500	42-229-4	268H	268	268	218	218	.456	.456	110°
MAGNUM Hydraulic Flat Tappet Camshafts												
HYDRAULIC – Great performance with stock to mild converter. Needs low gear in small engines, likes headers. Mild rough idle.	Hyd.	Hyd.	1800 to 5800	42-308-4	270H	270	270	224	224	.501	.501	110°
HYDRAULIC – Good for street machine with 2200+ stall. Use headers and lower gears. Rough idle.	Hyd.	Hyd.	2000 to 6000	42-231-4	280H	280	280	230	230	.490	.490	110°
HYDRAULIC – Street/strip, 3000+ stall, with aftermarket manifolds, lower gears, increased compression. Very rough idle.	Hyd.	Hyd.	2500 to 6500	42-236-4³⁷	292H	292	292	244	244	.518	.518	110°
HYDRAULIC – Pro Street/bracket race cam, good for large engines w/ 3500+ stall & low gears. Radical idle.	Hyd.	Hyd.	3000 to 6800	42-237-4³⁷	305H	305	305	253	253	.540	.540	110°
XTREME ENERGY™ Hydraulic Flat Tappet Camshafts												
HYDRAULIC – Very strong torque, excellent mileage, smooth idle.	Hyd.	Hyd.	600 to 4800	42-220-4	XE250H	250	260	206	212	.443	.448	110°
HYDRAULIC – Strong torque through low end and mid-range, good idle.	Hyd.	Hyd.	1000 to 5200	42-221-4	XE256H	256	268	212	218	.453	.456	110°
HYDRAULIC – Excellent response, good mileage, stock converter, mild gear.	Hyd.	Hyd.	1200 to 5600	42-222-4	XE262H	262	274	218	224	.475	.480	110°
HYDRAULIC – Good for street machines, slightly rough idle, 1800+ stall.	Hyd.	Hyd.	1600 to 5800	42-223-4	XE268H	268	280	224	230	.485	.490	110°
HYDRAULIC – High performance street, very strong mid-range. Needs headers and 2200+ stall.	Hyd.	Hyd.	1800 to 6000	42-224-4³⁷	XE274H	274	286	230	236	.520	.523	110°
HYDRAULIC – Street/strip, needs 9:1+ compression. 2800+ stall, headers, gears, rough idle.	Hyd.	Hyd.	2300 to 6500	42-225-4³⁷	XE284H	284	296	240	246	.541	.544	110°
HYDRAULIC – Pro Street/bracket, good intake, headers, gear, 3200+ stall.	Hyd.	Hyd.	2800 to 6800	42-226-4³⁷	XE294H	294	306	250	256	.554	.558	110°
THUMPR™ Hydraulic Flat Tappet Camshafts												
HYDRAULIC – Thumpr™ – High performance street, stock converter ok, best with 2000+ converter and gears. Choppy/thumping idle.	Hyd.	Hyd.	2000 to 5800	42-600-5	279TH7	278	296	226	241	.491	.476	107°
HYDRAULIC – Mutha' Thumpr™ – High performance street/strip, needs 9:1 compression, 2500+ stall, intake, gears and headers, rough idle.	Hyd.	Hyd.	2200 to 6100	42-601-5	287TH7	286	304	234	249	.500	.486	107°
HYDRAULIC – Big Mutha' Thumpr™ – Street/strip, needs 9.5:1 compression, 2800+ stall, intake, gears and headers, very rough idle.	Hyd.	Hyd.	2500 to 6400	42-602-5	295TH7	294	312	242	257	.512	.497	107°

1 Requires screw-in studs & guide plates

2 Requires machining on cylinder heads

7 Stock springs cannot be used

37 Adjustable valve train required

42 Olds 400-455 use Part #7582-16

OLDSMOBILE 260-455 C.I. 8 CYL. 1967-1990

CAMSHAFTS GENERAL MOTORS

K-KIT	SK-KIT	CL-KIT	RP-KIT	LIFTERS	TIMING SET	ROCKER ARMS	PUSHRODS	VALVE SPRINGS	RETAINERS	VALVE LOCKS	VALVE SEALS
HIGH ENERGY™ Hydraulic Flat Tappet Camshafts											
K42-227-4	SK42-227-4	CL42-227-4	1441-KIT ⁴⁴	852-16 863-16 ³⁷	3213 2113	1242-16	7842-16 ^{42,51}	901-16 995-16 ²	743-16 740-16	601-16 611-16	502-16 503-16 ²
K42-228-4	SK42-228-4	CL42-228-4	1441-KIT ⁴⁴	852-16 863-16 ³⁷	3213 2113	1242-16	7842-16 ^{42,51}	901-16 995-16 ²	743-16 740-16	601-16 611-16	502-16 503-16 ²
K42-229-4	SK42-229-4 ⁷	CL42-229-4 ⁷	1441-KIT ⁴⁴	852-16 863-16 ³⁷	3213 2113	1442-16 ¹ 19044-16 ¹	7842-16 ^{42,51}	901-16 995-16 ²	743-16 740-16	601-16 611-16	502-16 503-16 ²
MAGNUM Hydraulic Flat Tappet Camshafts											
K42-308-4	SK42-308-4 ⁷	CL42-308-4 ⁷	1441-KIT ⁴⁴	852-16 863-16 ³⁷	2113 3113	1442-16 ¹ 19044-16 ¹	7842-16 ^{42,51} 7131-16 ⁵¹	995-16 ² 26995-16 ²	740-16 795-16	611-16 614-16	503-16 ²
K42-231-4	SK42-231-4 ⁷	CL42-231-4 ⁷	1441-KIT ⁴⁴	852-16 863-16 ³⁷	2113 3113	1442-16 ¹ 19044-16 ¹	7842-16 ^{42,51} 7131-16 ⁵¹	995-16 ² 26995-16 ²	740-16 795-16	611-16 614-16	503-16 ²
K42-236-4 ³⁷	SK42-236-4 ^{7,37}	CL42-236-4 ^{7,37}	1441-KIT ⁴⁴	852-16 863-16 ³⁷	2113 3113	1442-16 ¹ 19044-16 ¹	7842-16 ^{42,51} 7131-16 ⁵¹	995-16 ² 26995-16 ²	740-16 795-16	611-16 614-16	503-16 ²
K42-237-4 ³⁷	SK42-237-4 ^{7,37}	CL42-237-4 ^{7,37}	1441-KIT ⁴⁴	852-16 863-16 ³⁷	2113 3113	1442-16 ¹ 19044-16 ¹	7842-16 ^{42,51} 7131-16 ⁵¹	995-16 ² 26995-16 ²	740-16 795-16	611-16 614-16	503-16 ²
XTREME ENERGY™ Hydraulic Flat Tappet Camshafts											
K42-220-4	SK42-220-4	CL42-220-4	1441-KIT ⁴⁴	852-16 863-16 ³⁷	3213 2113	1442-16 ¹ 19044-16 ¹	7842-16 ^{42,51} 7131-16 ⁵¹	901-16 995-16 ²	743-16 740-16	601-16 611-16	502-16 503-16 ²
K42-221-4	SK42-221-4 ⁷	CL42-221-4 ⁷	1441-KIT ⁴⁴	852-16 863-16 ³⁷	3213 2113	1442-16 ¹ 19044-16 ¹	7842-16 ^{42,51} 7131-16 ⁵¹	901-16 995-16 ²	743-16 740-16	601-16 611-16	502-16 503-16 ²
K42-222-4	SK42-222-4 ⁷	CL42-222-4 ⁷	1441-KIT ⁴⁴	852-16 863-16 ³⁷	3213 2113	1442-16 ¹ 19044-16 ¹	7842-16 ^{42,51} 7131-16 ⁵¹	901-16 995-16 ²	743-16 740-16	601-16 611-16	502-16 503-16 ²
K42-223-4	SK42-223-4 ⁷	CL42-223-4 ⁷	1441-KIT ⁴⁴	852-16 863-16 ³⁷	2113 3113	1442-16 ¹ 19044-16 ¹	7842-16 ^{42,51} 7131-16 ⁵¹	995-16 ² 26995-16 ²	740-16 795-16	611-16 614-16	503-16 ²
K42-224-4 ³⁷	SK42-224-4 ^{7,37}	CL42-224-4 ^{7,37}	1441-KIT ⁴⁴	852-16 863-16 ³⁷	2113 3113	1442-16 ¹ 19044-16 ¹	7842-16 ^{42,51} 7131-16 ⁵¹	995-16 ² 26995-16 ²	740-16 795-16	611-16 614-16	503-16 ²
K42-225-4 ³⁷	SK42-225-4 ^{7,37}	CL42-225-4 ^{7,37}	1441-KIT ⁴⁴	852-16 863-16 ³⁷	2113 3113	1442-16 ¹ 19044-16 ¹	7842-16 ^{42,51} 7131-16 ⁵¹	995-16 ² 26995-16 ²	740-16 795-16	611-16 614-16	503-16 ²
K42-226-4 ³⁷	SK42-226-4 ^{7,37}	CL42-226-4 ^{7,37}	1441-KIT ⁴⁴	852-16 863-16 ³⁷	2113 3113	1442-16 ¹ 19044-16 ¹	7842-16 ^{42,51} 7131-16 ⁵¹	995-16 ² 26995-16 ²	740-16 795-16	611-16 614-16	503-16 ²
THUMPR™ Hydraulic Flat Tappet Camshafts											
K42-600-5 ³⁷	N/A	CL42-600-5 ^{7,37}	1441-KIT ⁴⁴	852-16 863-16 ³⁷	2113 3113	1442-16 ¹ 19044-16 ¹	7842-16 ^{42,51} 7131-16 ⁵¹	995-16 ² 26995-16 ²	740-16 795-16	611-16 614-16	503-16 ²
K42-601-5 ³⁷	N/A	CL42-601-5 ^{7,37}	1441-KIT ⁴⁴	852-16 863-16 ³⁷	2113 3113	1442-16 ¹ 19044-16 ¹	7842-16 ^{42,51} 7131-16 ⁵¹	995-16 ² 26995-16 ²	740-16 795-16	611-16 614-16	503-16 ²
K42-602-5 ³⁷	N/A	CL42-602-5 ^{7,37}	1441-KIT ⁴⁴	852-16 863-16 ³⁷	2113 3113	1442-16 ¹ 19044-16 ¹	7842-16 ^{42,51} 7131-16 ⁵¹	995-16 ² 26995-16 ²	740-16 795-16	611-16 614-16	503-16 ²

⁴⁴ For 260-403 engines only. 455 use kit Part #1442-KIT.

⁵¹ Pushrod length may vary depending on combination, check for proper length

RED NUMBERS DENOTE PREMIUM OPTION

OLDSMOBILE 260-455 C.I. 8 CYL. 1967-1990 (CONTINUED)

APPLICATIONS/CAMSHAFTS	VALVE SETTING		RPM OPERATING RANGE	CAM PART #	CAM GRIND #	DURATION				VALVE LIFT		LOBE SEP. ANGLE
	IN.	EX.				ADVERTISED IN.	EX.	@ .050" IN.	EX.	W/ 1.6 ROCKER IN.	EX.	
MARINE Hydraulic Flat Tappet Camshafts												
HYDRAULIC – Best cam for economy and improved power. Skiing and pleasure boating.	Hyd.	Hyd.	1500 to 5500	42-229-4	268H	268	268	218	218	.456	.456	110°
HYDRAULIC – Great cam for 455 jet boat with A or B impeller. Performance and skiing.	Hyd.	Hyd.	2000 to 6000	42-231-4	280H	280	280	230	230	.490	.490	110°
HYDRAULIC – Performance cam for B impeller in jet boat. River or bracket racing.	Hyd.	Hyd.	2500 to 6500	42-236-4³⁷	292H	292	292	244	244	.518	.518	110°
DUAL ENERGY™ Hydraulic Flat Tappet Camshafts												
HYDRAULIC – Good torque and mileage, great economy and towing cam.	Hyd.	Hyd.	1000 to 5000	42-207-4	255DEH	255	263	203	215	.433	.467	110°
HYDRAULIC – Strong mid-range, everyday performance for stock exhaust.	Hyd.	Hyd.	1200 to 5500	42-208-4	265DEH	265	273	211	223	.472	.486	110°
HYDRAULIC – High performance street, great power, works with stock converter, best with 2000+ stall.	Hyd.	Hyd.	1500 to 5800	42-210-4³⁷	275DEH	275	282	219	233	.476	.508	110°
FACTORY MUSCLE™ Hydraulic Flat Tappet Camshafts (Today's OEM Versions Of Yesterday's Muscle Car Cams)												
HYDRAULIC – Factory I.D. # 402194 for: 350c.i., 1968-70, factory 325 HP 455c.i., 1968, factory 370 HP 455c.i., 1971, factory 340 HP	Hyd.	Hyd.	1800 to 5800	42-114-3	194H	308	308	233	233	.474	.474	113°
MAGNUM MUSCLE Hydraulic Flat Tappet Camshafts (Today's Versions Of Yesterday's Muscle Car Cams)												
HYDRAULIC – Magnum Muscle Camshaft for: 350c.i., 1968-70, factory 325 HP 455c.i., 1968, factory 370 HP 455c.i., 1971, factory 340 HP	Hyd.	Hyd.	1600 to 5600	42-231-4	280H	280	280	230	230	.490	.490	110°
XTREME ENERGY™ Retro-Fit Hydraulic Roller Camshafts												
HYDRAULIC ROLLER – Daily driver, strong torque, smooth idle.	Hyd.	Hyd.	1000 to 5000	42-413-9^{5,37}	XR262HR	262	268	210	216	.505	.505	110°
HYDRAULIC ROLLER – Great for street machines, needs headers, low gears, and 2200+ stall.	Hyd.	Hyd.	1800 to 5600	42-423-9^{5,37}	XR276HR	276	282	224	230	.505	.505	110°
HYDRAULIC ROLLER – Rough idle, needs 2800+ stall, lower gears and 9.5:1 compression.	Hyd.	Hyd.	2200 to 6000	42-433-9^{5,37}	XR290HR	290	296	236	242	.515	.533	110°
THUMPR™ Retro-Fit Hydraulic Roller Camshafts												
HYDRAULIC ROLLER – Thumpr™ – High performance street, stock converter ok, best with 2000+ converter and gears, choppy/thumping idle.	Hyd.	Hyd.	1700 to 5500	42-600-9^{5,37}	283THR7	283	303	227	241	.531	.515	107°
HYDRAULIC ROLLER – Mutha' Thumpr™ – High performance street/strip, needs 9:1 compression, 2500+ stall, intake, gears and headers, rough idle.	Hyd.	Hyd.	2000 to 5800	42-601-9^{5,37}	291THR7	291	311	235	249	.540	.526	107°
HYDRAULIC ROLLER – Big Mutha' Thumpr™ – Street/strip, needs 9.5:1 compression, 2800+ stall, intake, gears and headers, very rough idle.	Hyd.	Hyd.	2300 to 6100	42-602-9^{5,37}	299THR7	299	319	243	257	.552	.537	107°

¹ Requires screw-in studs & guide plates
² Requires machining on cylinder heads
⁵ Requires distributor gear upgrade

⁷ Stock springs cannot be used
³⁷ Adjustable valve train required
⁴² Olds 400-455 use Part #7582-16

⁴⁴ For 260-403 engines only. 455 use kit Part #1442-KIT.

OLDSMOBILE 260-455 C.I. 8 CYL. 1967-1990 (CONTINUED)

CAMSHAFTS GENERAL MOTORS

K-KIT	SK-KIT	CL-KIT	RP-KIT	LIFTERS	TIMING SET	ROCKER ARMS	PUSHRODS	VALVE SPRINGS	RETAINERS	VALVE LOCKS	VALVE SEALS
MARINE Hydraulic Flat Tappet Camshafts											
K42-229-4	SK42-229-4 ⁷	CL42-229-4 ⁷	1441-KIT ⁴⁴	852-16 863-16 ³⁷	2113 3113	1442-16 ¹ 19044-16 ¹	7842-16 ^{42,51} 7131-16 ⁵¹	901-16 995-16 ²	743-16 740-16	601-16 611-16	502-16 503-16 ²
K42-231-4	SK42-231-4 ⁷	CL42-231-4 ⁷	1441-KIT ⁴⁴	852-16 863-16 ³⁷	2113 3113	1442-16 ¹ 19044-16 ¹	7842-16 ^{42,51} 7131-16 ⁵¹	995-16 ² 26995-16 ²	740-16 795-16	611-16 614-16	503-16 ²
K42-236-4 ³⁷	SK42-236-4 ^{7,37}	CL42-236-4 ^{7,37}	1441-KIT ⁴⁴	852-16 863-16 ³⁷	2113 3113	1442-16 ¹ 19044-16 ¹	7842-16 ^{42,51} 7131-16 ⁵¹	995-16 ² 26995-16 ²	740-16 795-16	611-16 614-16	503-16 ²
DUAL ENERGY™ Hydraulic Flat Tappet Camshafts											
K42-207-4	SK42-207-4 ⁷	CL42-207-4 ⁷	1441-KIT ⁴⁴	852-16	3213 2113	1442-16 ¹ 19044-16 ¹	7842-16 ^{42,51} 7131-16 ⁵¹	901-16 995-16 ²	743-16 740-16	601-16 611-16	502-16 503-16 ²
K42-208-4	SK42-208-4 ⁷	CL42-208-4 ⁷	1441-KIT ⁴⁴	852-16	3213 2113	1442-16 ¹ 19044-16 ¹	7842-16 ^{42,51} 7131-16 ⁵¹	901-16 995-16 ²	743-16 740-16	601-16 611-16	502-16 503-16 ²
K42-210-4 ³⁷	SK42-210-4 ^{7,37}	CL42-210-4 ^{7,37}	1441-KIT ⁴⁴	852-16	3213 2113	1442-16 ¹ 19044-16 ¹	7842-16 ^{42,51} 7131-16 ⁵¹	995-16 ² 26995-16 ²	740-16 795-16	611-16 614-16	503-16 ²
LIFTERS	TIMING SET	ROCKER ARMS	PUSHRODS	VALVE SPRINGS	RETAINERS	VALVE LOCKS	VALVE SEALS	LASH CAPS	REV KIT	DIST. GEAR	STUD GIRDLES
FACTORY MUSCLE™ Hydraulic Flat Tappet Camshafts (Today's OEM Versions Of Yesterday's Muscle Car Cams)											
852-16 863-16 ³⁷	2113 3113	1442-16 ¹ 1044-16 ¹	7842-16 ^{42,51} 7131-16 ⁵¹	901-16 995-16 ²	743-16 740-16	601-16 611-16	502-16 503-16 ²	N/A	N/A	442	N/A
MAGNUM MUSCLE Hydraulic Flat Tappet Camshafts (Today's Versions Of Yesterday's Muscle Car Cams)											
852-16 863-16 ³⁷	2113 3113	1442-16 ¹ 1044-16 ¹	7842-16 ^{42,51} 7131-16 ⁵¹	901-16 995-16 ²	743-16 740-16	601-16 611-16	502-16 503-16 ²	N/A	N/A	442	N/A
K-KIT	SK-KIT	CL-KIT	RP-KIT	LIFTERS	TIMING SET	ROCKER ARMS	PUSHRODS	VALVE SPRINGS	RETAINERS	VALVE LOCKS	VALVE SEALS
XTREME ENERGY™ Retro-Fit Hydraulic Roller Camshafts											
K42-413-9 ^{5,37}	SK42-413-9 ^{5,7,37}	CL42-413-9 ^{5,7,37}	N/A	857-16	2113 3113	1442-16 ¹ 19044-16 ¹	7645-16 ^{51,66}	995-16 ² 26995-16 ²	740-16 795-16	611-16 614-16	503-16 ²
K42-423-9 ^{5,37}	SK42-423-9 ^{5,7,37}	CL42-423-9 ^{5,7,37}	N/A	857-16	2113 3113	1442-16 ¹ 19044-16 ¹	7645-16 ^{51,66}	995-16 ² 26995-16 ²	740-16 795-16	611-16 614-16	503-16 ²
K42-433-9 ^{5,37}	SK42-433-9 ^{5,7,37}	CL42-433-9 ^{5,7,37}	N/A	857-16	2113 3113	1442-16 ¹ 1044-16 ¹	7645-16 ^{51,66}	995-16 ² 26995-16 ²	740-16 795-16	611-16 614-16	503-16 ²
THUMPR™ Retro-Fit Hydraulic Roller Camshafts											
K42-600-9 ^{5,37}	N/A	CL42-600-9 ^{5,7,37}	N/A	857-16	2113 3113	1442-16 ¹ 19044-16 ¹	7645-16 ^{51,66}	995-16 ² 26995-16 ²	740-16 795-16	611-16 614-16	503-16 ²
K42-601-9 ^{5,37}	N/A	CL42-601-9 ^{5,7,37}	N/A	857-16	2113 3113	1442-16 ¹ 19044-16 ¹	7645-16 ^{51,66}	995-16 ² 26995-16 ²	740-16 795-16	611-16 614-16	503-16 ²
K42-602-9 ^{5,37}	N/A	CL42-602-9 ^{5,7,37}	N/A	857-16	2113 3113	1442-16 ¹ 19044-16 ¹	7645-16 ^{51,66}	995-16 ² 26995-16 ²	740-16 795-16	611-16 614-16	503-16 ²

⁵¹ Pushrod length may vary depending on combination, check for proper length

⁶⁶ For 455 use Part #7783-16

OLDSMOBILE 260-455 C.I. 8 CYL. 1967-1990 (CONTINUED)

APPLICATIONS/CAMSHAFTS	VALVE SETTING		RPM OPERATING RANGE	CAM PART #	CAM GRIND #	DURATION				VALVE LIFT		LOBE SEP. ANGLE
	IN.	EX.				ADVERTISED IN.	EX.	@ .050" IN.	EX.	W/ 1.6 ROCKER IN.	EX.	
DRAG RACE Mechanical Flat Tappet Camshaft												
SOLID – Great torque in full body car with 400c.i. and 3500+ stall.	.026	.028	3500 to 6500	42-655-5	285B-8	285	294	250	256	.568	.545	108°

PONTIAC 151 C.I. (2.5L IRON DUKE) 4 CYL. 1978-1989

APPLICATIONS/CAMSHAFTS	VALVE SETTING		RPM OPERATING RANGE	CAM PART #	CAM GRIND #	DURATION				VALVE LIFT		LOBE SEP. ANGLE
	IN.	EX.				ADVERTISED IN.	EX.	@ .050" IN.	EX.	W/ 1.75 ROCKER IN.	EX.	
HIGH ENERGY™ Hydraulic Flat Tappet Camshafts (TWO GEARS ON CAM CORE)												
HYDRAULIC – Our best cam for economy. Excellent torque.	Hyd.	Hyd.	500 to 4500	52-115-4	240H	240	248	192	200	.455	.455	108°
HYDRAULIC – Good torque and power with smooth idle. Strong increase over stock cam.	Hyd.	Hyd.	800 to 4800	52-119-4	252H	252	252	206	206	.474	.474	110°
HYDRAULIC – Good combination of torque and power. Performance street driving.	Hyd.	Hyd.	1200 to 5200	52-123-4	260H	260	260	212	212	.489	.489	110°
HI-TECH™ Mechanical Flat Tappet Camshafts (TWO GEARS ON CAM CORE)												
SOLID – Oval track/bracket race/street stock. After-market 2 BBL or stock carb.	.022	.024	3000 to 6000	52-500-5⁷	272TL-5	272	272	242	242	.595	.595	105°
SOLID – Oval track/bracket race/street stock. Same as 272 with slightly more RPM.	.022	.024	3500 to 6500	52-502-5⁷	276TL-5	276	276	246	246	.606	.606	105°

PONTIAC 151 C.I. 4 CYL. 1977-1993

APPLICATIONS/CAMSHAFTS	VALVE SETTING		RPM OPERATING RANGE	CAM PART #	CAM GRIND #	DURATION				VALVE LIFT		LOBE SEP. ANGLE
	IN.	EX.				ADVERTISED IN.	EX.	@ .050" IN.	EX.	W/ 1.75 ROCKER IN.	EX.	
HIGH ENERGY™ Hydraulic Flat Tappet Camshafts (ONE GEAR ON CAM CORE)												
HYDRAULIC – Good torque and power with smooth idle. Strong increase over stock cam.	Hyd.	Hyd.	800 to 4800	14-119-4	252H	252	252	206	206	.474	.474	110°
HYDRAULIC – Good combination of torque and power. Performance street and marine.	Hyd.	Hyd.	1200 to 5200	14-123-4	260H	260	260	212	212	.489	.489	110°

PONTIAC 265-455 C.I. 8 CYL. 1955-1981

APPLICATIONS/CAMSHAFTS	VALVE SETTING		RPM OPERATING RANGE	CAM PART #	CAM GRIND #	DURATION				VALVE LIFT		LOBE SEP. ANGLE
	IN.	EX.				ADVERTISED IN.	EX.	@ .050" IN.	EX.	W/ 1.5 ROCKER IN.	EX.	
HIGH ENERGY™ Hydraulic Flat Tappet Camshafts												
HYDRAULIC – Smooth idle with fuel economy for 326 to 400c.i. Strong torque. Best cam for 301.	Hyd.	Hyd.	800 to 4800	51-229-3	252H	252	252	206	206	.425	.425	110°
HYDRAULIC – Smooth idle, good mileage for 455c.i. Strong towing cam. Good power for 326-400c.i.	Hyd.	Hyd.	1200 to 5200	51-230-3	260H	260	260	212	212	.440	.440	110°
HYDRAULIC – Good low end and mid-range torque. Street performance, noticeable idle.	Hyd.	Hyd.	1500 to 5500	51-232-3	268H	268	268	218	218	.454	.454	110°

¹ Requires screw-in studs & guide plates
² Requires machining on cylinder heads
⁷ Stock springs cannot be used

⁸ Fits only certain years
³⁷ Adjustable valve train required
⁴³ Olds 260-403 use Part #7842-16

⁴⁵ 265-301 use Part #864-16
⁴⁷ 1.65:1 ratio available

OLDSMOBILE 260-455 C.I. 8 CYL. 1967-1990 (CONTINUED)

LIFTERS	TIMING SET	ROCKER ARMS	PUSHRODS	VALVE SPRINGS	RETAINERS	VALVE LOCKS	VALVE SEALS	LASH CAPS	REV KIT	DIST. GEAR	STUD GIRDLES
DRAG RACE Mechanical Flat Tappet Camshaft											
813-16 ³⁷ 800-16 ³⁷	3113 3113KT	19044-16 ¹	7582-16 ⁴³	950-16 ² 26094-16 ²	740-16 730-16	611-16 614-16	503-16 ²	621-16	N/A	442	N/A

PONTIAC 151 C.I. (2.5L IRON DUKE) 4 CYL. 1978-1989

K-KIT	SK-KIT	CL-KIT	RP-KIT	LIFTERS	TIMING SET	ROCKER ARMS	PUSHRODS	VALVE SPRINGS	RETAINERS	VALVE LOCKS	VALVE SEALS
HIGH ENERGY™ Hydraulic Flat Tappet Camshafts (TWO GEARS ON CAM CORE)											
K52-115-4	SK52-115-4	CL52-115-4	N/A	864-8	3252	N/A	N/A	988-8	743-8	601-8	501-8
K52-119-4	SK52-119-4	CL52-119-4	N/A	864-8	3252	N/A	N/A	988-8	743-8	601-8	501-8
K52-123-4	SK52-123-4 ⁷	CL52-123-4 ⁷	N/A	864-8	3252	N/A	N/A	988-8	743-8	601-8	501-8
HI-TECH™ Mechanical Flat Tappet Camshafts (TWO GEARS ON CAM CORE)											
N/A	N/A	N/A	N/A	2900-8	3252	N/A	N/A	986-8 ² 987-8 ²	740-8 730-8	611-8	503-8 ²
N/A	N/A	N/A	N/A	2900-8	3252	N/A	N/A	986-8 ² 987-8 ²	740-8 730-8	611-8	503-8 ²

PONTIAC 151 C.I. 4 CYL. 1977-1993

K-KIT	SK-KIT	CL-KIT	RP-KIT	LIFTERS	TIMING SET	ROCKER ARMS	PUSHRODS	VALVE SPRINGS	RETAINERS	VALVE LOCKS	VALVE SEALS
HIGH ENERGY™ Hydraulic Flat Tappet Camshafts (ONE GEAR ON CAM CORE)											
K14-119-4	SK14-119-4	CL14-119-4	N/A	812-8	3211	1261-8	7861-8	981-8 26981-8	742-8 787-8	601-8	501-8
K14-123-4	SK14-123-4 ⁷	CL14-123-4 ⁷	N/A	812-8	3211	1261-8	7861-8	981-8 26981-8	742-8 787-8	601-8	501-8

PONTIAC 265-455 C.I. 8 CYL. 1955-1981

K-KIT	SK-KIT	CL-KIT	RP-KIT	LIFTERS	TIMING SET	ROCKER ARMS	PUSHRODS	VALVE SPRINGS	RETAINERS	VALVE LOCKS	VALVE SEALS
HIGH ENERGY™ Hydraulic Flat Tappet Camshafts											
K51-229-3	SK51-229-3	CL51-229-3	RP1451-16 ⁴⁷	852-16 ⁴⁵	3212	1451-16 ⁴⁷	7851-16 ⁸	988-16	743-16	601-16	501-16
K51-230-3	SK51-230-3	CL51-230-3	RP1451-16 ⁴⁷	852-16 ⁴⁵	3212	1451-16 ⁴⁷	7851-16 ⁸	988-16	743-16	601-16	501-16
K51-232-3	SK51-232-3 ⁷	CL51-232-3 ⁷	RP1451-16 ⁴⁷	852-16 ⁴⁵	3212	1451-16 ⁴⁷	7851-16 ⁸	988-16	743-16	601-16	501-16

RED NUMBERS DENOTE PREMIUM OPTION

PONTIAC 265-455 C.I. 8 CYL. 1955-1981 (CONTINUED)

APPLICATIONS/CAMSHAFTS	VALVE SETTING		RPM OPERATING RANGE	CAM PART #	CAM GRIND #	DURATION				VALVE LIFT		LOBE SEP. ANGLE
	IN.	EX.				IN.	EX.	IN.	EX.	IN.	EX.	
MAGNUM Hydraulic Flat Tappet Camshafts												
HYDRAULIC – Fair idle, good mid-range torque. Can use stock torque converter, best with 2000+ stall. Daily performance use.	Hyd.	Hyd.	1800 to 5800	51-233-4	270H	270	270	224	224	.476	.476	110°
HYDRAULIC – Choppy idle, increased compression advised. Needs 2500+ stall and lower gear, use headers.	Hyd.	Hyd.	2000 to 6000	51-234-4	280H	280	280	230	230	.480	.480	110°
HYDRAULIC – Rough idle, performance usage. Increased compression required. Needs 3000+ stall and 3.73 or lower gears.	Hyd.	Hyd.	2500 to 6500	51-240-4	292H	292	292	244	244	.501	.501	110°
HYDRAULIC – Racy idle. Bracket racing cam. Needs 10.5:1 compression and 3500+ stall. Low gear ratio.	Hyd.	Hyd.	3000 to 6500	51-241-4	305H	305	305	253	253	.525	.525	110°
XTREME ENERGY™ Hydraulic Flat Tappet Camshafts												
HYDRAULIC – Very strong torque, excellent mileage, smooth idle.	Hyd.	Hyd.	600 to 4800	51-220-4	XE250H	250	260	206	212	.432	.444	110°
HYDRAULIC – Strong torque through low end and mid-range, good idle.	Hyd.	Hyd.	1000 to 5200	51-221-4	XE256H	256	268	212	218	.447	.455	110°
HYDRAULIC – Excellent response, good mileage, stock converter or 1800 stall. Mild gear.	Hyd.	Hyd.	1300 to 5500	51-222-4	XE262H	262	270	218	224	.462	.470	110°
HYDRAULIC – Good for street machines, slightly rough idle. 2000+ stall.	Hyd.	Hyd.	1600 to 5800	51-223-4	XE268H	268	280	224	230	.477	.480	110°
HYDRAULIC – High performance street, very strong mid-range, headers and 2200+ stall.	Hyd.	Hyd.	1800 to 6000	51-224-4	XE274H	274	286	230	236	.488	.491	110°
HYDRAULIC – Street/strip, needs 9:1+ compression. 2800+ stall, headers, gears, rough idle.	Hyd.	Hyd.	2300 to 6500	51-225-4	XE284H	284	296	240	246	.507	.510	110°
HYDRAULIC – Pro Street/bracket, good intake, headers, gear, 3500+ stall.	Hyd.	Hyd.	2800 to 6500	51-226-4	XE294H	294	306	250	256	.519	.524	110°
THUMPR™ Hydraulic Flat Tappet Camshafts												
HYDRAULIC – Thumpr™-High performance street, stock converter ok, best with 2000+ converter and gears. Choppy/thumping idle.	Hyd.	Hyd.	2000 to 5800	51-600-5	279TH7	279	297	227	241	.478	.465	107°
HYDRAULIC – Mutha' Thumpr™-High performance street/strip, needs 9:1 compression, 2500+ stall, intake, gears and headers, rough idle.	Hyd.	Hyd.	2200 to 6100	51-601-5	287TH7	287	305	235	249	.490	.475	107°
HYDRAULIC – Big Mutha' Thumpr™-Street/strip, needs 9.5:1 compression, 2800+ stall, intake, gears and headers, very rough idle.	Hyd.	Hyd.	2500 to 6400	51-602-5	295TH7	295	313	243	257	.501	.486	107°

¹ Requires screw-in studs & guide plates

² Requires machining on cylinder heads.

⁷ Stock springs cannot be used

⁸ Fits only certain years

³⁷ Adjustable valve train required

⁴⁵ 265-301 use Part #864-16

⁴⁷ 1.65:1 ratio available

PONTIAC 265-455 C.I. 8 CYL. 1955-1981 (CONTINUED)

CAMSHAFTS GENERAL MOTORS

K-KIT	SK-KIT	CL-KIT	RP-KIT	LIFTERS	TIMING SET	ROCKER ARMS	PUSHRODS	VALVE SPRINGS	RETAINERS	VALVE LOCKS	VALVE SEALS
MAGNUM Hydraulic Flat Tappet Camshafts											
K51-233-4	SK51-233-4 ⁷	CL51-233-4 ⁷	RP1451-16 ⁴⁷	852-16 ⁴⁵ 863-16 ^{37,45}	2112 3112	1451-16 ⁴⁷ 19060-16 ^{1,47}	7262-16 ⁸ 7786-16 ⁸	995-16 ² 26995-16 ²	740-16 795-16	611-16 614-16	503-16 ²
K51-234-4	SK51-234-4 ⁷	CL51-234-4 ⁷	RP1451-16 ⁴⁷	852-16 ⁴⁵ 863-16 ^{37,45}	2112 3112	1451-16 ⁴⁷ 19060-16 ^{1,47}	7262-16 ⁸ 7786-16 ⁸	995-16 ² 26995-16 ²	740-16 795-16	611-16 614-16	503-16 ²
K51-240-4	SK51-240-4 ⁷	CL51-240-4 ⁷	RP1451-16 ⁴⁷	852-16 ⁴⁵ 863-16 ^{37,45}	2112 3112	1451-16 ⁴⁷ 19060-16 ^{1,47}	7262-16 ⁸ 7786-16 ⁸	995-16 ² 26995-16 ²	740-16 795-16	611-16 614-16	503-16 ²
K51-241-4	SK51-241-4 ⁷	CL51-241-4 ⁷	RP1451-16 ⁴⁷	852-16 ⁴⁵ 863-16 ^{37,45}	2112 3112	1451-16 ⁴⁷ 19060-16 ^{1,47}	7262-16 ⁸ 7786-16 ⁸	995-16 ² 26995-16 ²	740-16 795-16	611-16 614-16	503-16 ²
XTREME ENERGY™ Hydraulic Flat Tappet Camshafts											
K51-220-4	SK51-220-4	CL51-220-4	RP1451-16 ⁴⁷	852-16 ⁴⁵ 863-16 ^{37,45}	3212 2112	1451-16 ⁴⁷ 19060-16 ^{1,47}	7851-16 ⁸ 7262-16 ⁸	988-16	743-16	601-16	501-16
K51-221-4	SK51-221-4	CL51-221-4	RP1451-16 ⁴⁷	852-16 ⁴⁵ 863-16 ^{37,45}	3212 2112	1451-16 ⁴⁷ 19060-16 ^{1,47}	7851-16 ⁸ 7262-16 ⁸	988-16	743-16	601-16	501-16
K51-222-4	SK51-222-4 ⁷	CL51-222-4 ⁷	RP1451-16 ⁴⁷	852-16 ⁴⁵ 863-16 ^{37,45}	3212 2112	1451-16 ⁴⁷ 19060-16 ^{1,47}	7851-16 ⁸ 7262-16 ⁸	988-16	743-16	601-16	501-16
K51-223-4	SK51-223-4 ⁷	CL51-223-4 ⁷	RP1451-16 ⁴⁷	852-16 ⁴⁵ 863-16 ^{37,45}	2112 3112	1451-16 ⁴⁷ 19060-16 ^{1,47}	7262-16 ⁸ 7786-16 ⁸	995-16 ² 26995-16 ²	740-16 795-16	611-16 614-16	503-16 ²
K51-224-4	SK51-224-4 ⁷	CL51-224-4 ⁷	RP1451-16 ⁴⁷	852-16 ⁴⁵ 863-16 ^{37,45}	2112 3112	1451-16 ⁴⁷ 19060-16 ^{1,47}	7262-16 ⁸ 7786-16 ⁸	995-16 ² 26995-16 ²	740-16 795-16	611-16 614-16	503-16 ²
K51-225-4	SK51-225-4 ⁷	CL51-225-4 ⁷	RP1451-16 ⁴⁷	852-16 ⁴⁵ 863-16 ^{37,45}	2112 3112	1451-16 ⁴⁷ 19060-16 ^{1,47}	7262-16 ⁸ 7786-16 ⁸	995-16 ² 26995-16 ²	740-16 795-16	611-16 614-16	503-16 ²
K51-226-4	SK51-226-4 ⁷	CL51-226-4 ⁷	RP1451-16 ⁴⁷	852-16 ⁴⁵ 863-16 ^{37,45}	2112 3112	1451-16 ⁴⁷ 19060-16 ^{1,47}	7262-16 ⁸ 7786-16 ⁸	995-16 ² 26995-16 ²	740-16 795-16	611-16 614-16	503-16 ²
THUMPR™ Hydraulic Flat Tappet Camshafts											
K51-600-5	N/A	CL51-600-5 ⁷	RP1451-16 ⁴⁷	852-16 ⁴⁵ 863-16 ^{37,45}	2112 3112	1451-16 ⁴⁷ 19060-16 ^{1,47}	7262-16 ⁸ 7786-16 ⁸	995-16 ² 26995-16 ²	740-16 795-16	611-16 614-16	503-16 ²
K51-601-5	N/A	CL51-601-5 ⁷	RP1451-16 ⁴⁷	852-16 ⁴⁵ 863-16 ^{37,45}	2112 3112	1451-16 ⁴⁷ 19060-16 ^{1,47}	7262-16 ⁸ 7786-16 ⁸	995-16 ² 26995-16 ²	740-16 795-16	611-16 614-16	503-16 ²
K51-602-5	N/A	CL51-602-5 ⁷	RP1451-16 ⁴⁷	852-16 ⁴⁵ 863-16 ^{37,45}	2112 3112	1451-16 ⁴⁷ 19060-16 ^{1,47}	7262-16 ⁸ 7786-16 ⁸	995-16 ² 26995-16 ²	740-16 795-16	611-16 614-16	503-16 ²

RED NUMBERS DENOTE PREMIUM OPTION

PONTIAC 265-455 C.I. 8 CYL. 1955-1981 (CONTINUED)

APPLICATIONS/CAMSHAFTS	VALVE SETTING		RPM OPERATING RANGE	CAM PART #	CAM GRIND #	DURATION				VALVE LIFT		LOBE SEP. ANGLE
	IN.	EX.				ADVERTISED IN.	EX.	@ .050" IN.	EX.	W/ 1.65 ROCKER IN.	EX.	
DUAL ENERGY™ Hydraulic Flat Tappet Camshafts												
HYDRAULIC – Good torque and mileage, good RV and towing cam, smooth idle.	Hyd.	Hyd.	1000 to 5000	51-206-4	255DEH	255	261	202	212	.420	.450	110°
HYDRAULIC – Strong mid-range. Everyday performance cam for stock exhaust.	Hyd.	Hyd.	1200 to 5500	51-207-4	265DEH	265	269	211	221	.442	.465	110°
HYDRAULIC – High performance street. Works with stock converter, better with mild stall.	Hyd.	Hyd.	1500 to 5800	51-208-4	275DEH	275	277	219	228	.462	.480	110°

APPLICATIONS/CAMSHAFTS	VALVE SETTING		RPM OPERATING RANGE	CAM PART #	CAM GRIND #	DURATION				VALVE LIFT		LOBE SEP. ANGLE
	IN.	EX.				ADVERTISED IN.	EX.	@ .050" IN.	EX.	W/ 1.65 ROCKER IN.	EX.	
FACTORY MUSCLE™ Hydraulic Flat Tappet Camshafts (Today's OEM Versions Of Yesterday's Muscle Car Cams)												
HYDRAULIC – Factory I.D. #9794041 for: 400c.i., 1968 RAM AIR IV, factory 366 HP 400c.i., 1969, factory 345/370 HP 455c.i., 1970, factory 370 HP	Hyd.	Hyd.	1800 to 5700	51-116-3	041H	292	303	231	240	.516	.516	114°
MAGNUM MUSCLE Hydraulic Flat Tappet Camshafts (Today's Versions Of Yesterday's Muscle Car Cams)												
HYDRAULIC – Magnum Muscle Camshaft for: 400c.i., 1968 RAM AIR IV, factory 366 HP 400c.i., 1969, factory 345/370 HP 455c.i., 1970, factory 370 HP	Hyd.	Hyd.	1500 to 5500	51-314-4	280AH-10	280	280	232	237	.531	.531	110°
DRAG RACE Hydraulic Flat Tappet Camshafts												
HYDRAULIC – Bracket race with heavy car. 2500-3000 stall, 9.5:1+ compression, more gear, choppy idle.	Hyd.	Hyd.	2000 to 6000	51-309-4	276AH-10	276	284	228	236	.520	.520	110°
HYDRAULIC – Rough idle, 3500+ stall, 10:1+ compression, 4:10 or lower gear ratio.	Hyd.	Hyd.	3000 to 6500	51-316-4	296AH-8	296	305	246	253	.562	.577	108°
HYDRAULIC – Racy idle, bracket racing. Needs 10.5:1+ compression and 3500+ stall, low gear ratio.	Hyd.	Hyd.	3500 to 6500	51-241-4	305H-10	305	305	253	253	.525	.525	110°

APPLICATIONS/CAMSHAFTS	VALVE SETTING		RPM OPERATING RANGE	CAM PART #	CAM GRIND #	DURATION				VALVE LIFT		LOBE SEP. ANGLE
	IN.	EX.				ADVERTISED IN.	EX.	@ .050" IN.	EX.	W/ 1.65 ROCKER IN.	EX.	
XTREME ENERGY™ Retro-Fit Hydraulic Roller Camshafts												
HYDRAULIC ROLLER – Daily driver, strong torque, smooth idle.	Hyd.	Hyd.	1000 to 5000	51-413-9⁵	XR264HR	264	270	212	218	.487	.495	110°
HYDRAULIC ROLLER – Great for street machines, needs headers, low gears and 2200+ stall.	Hyd.	Hyd.	1800 to 5600	51-423-9⁵	XR276HR	276	282	224	230	.502	.510	110°
HYDRAULIC ROLLER – Rough idle, needs 2800+ stall, lower gears and 9.5:1 compression.	Hyd.	Hyd.	2200 to 6000	51-433-9⁵	XR288HR	288	294	236	242	.520	.540	110°

¹ Requires screw-in studs & guide plates² Requires machining on cylinder heads⁵ Requires distributor gear upgrade⁷ Stock springs cannot be used⁸ Fits only certain years³⁷ Adjustable valve train required

PONTIAC 265-455 C.I. 8 CYL. 1955-1981 (CONTINUED)

K-KIT	SK-KIT	CL-KIT	RP-KIT	LIFTERS	TIMING SET	ROCKER ARMS	PUSHRODS	VALVE SPRINGS	RETAINERS	VALVE LOCKS	VALVE SEALS
DUAL ENERGY™ Hydraulic Flat Tappet Camshafts											
K51-206-4	SK51-206-4 ⁷	CL51-206-4 ⁷	RP1451-16 ⁴⁷	852-16 ⁴⁵	3212	1451-16 ⁴⁷	7851-16 ⁸	988-16	743-16	601-16	501-16
K51-207-4	SK51-207-4 ⁷	CL51-207-4 ⁷	RP1451-16 ⁴⁷	852-16 ⁴⁵	3212	1451-16 ⁴⁷	7851-16 ⁸	988-16	743-16	601-16	501-16
K51-208-4	SK51-208-4 ⁷	CL51-208-4 ⁷	RP1451-16 ⁴⁷	852-16 ⁴⁵	3212	1451-16 ⁴⁷	7851-16 ⁸	988-16	743-16	601-16	501-16

LIFTERS	TIMING SET	ROCKER ARMS	PUSHRODS	VALVE SPRINGS	RETAINERS	VALVE LOCKS	VALVE SEALS	LASH CAPS	REV KIT	DIST. GEAR	STUD GIRDLES
FACTORY MUSCLE™ Hydraulic Flat Tappet Camshafts (Today's OEM Versions Of Yesterday's Muscle Car Cams)											
852-16 ⁴⁵	2112 3112	1452-16 19061-16 ^{1,47}	7262-16 ⁷³ 7786-16 ⁷³	995-16 ² 26995-16 ²	740-16 795-16	614-16	503-16 ²	621-16	N/A	451	4051

MAGNUM MUSCLE Hydraulic Flat Tappet Camshafts (Today's Versions Of Yesterday's Muscle Car Cams)											
852-16 ⁴⁵	2112 3112	1452-16 19061-16 ^{1,47}	7262-16 ⁷³ 7786-16 ⁷³	995-16 ² 26995-16 ²	740-16 795-16	614-16	503-16 ²	621-16	N/A	451	4051

DRAG RACE Hydraulic Flat Tappet Camshafts											
863-16 ^{37,45}	3112	1452-16 19061-16 ^{1,47}	7262-16 ⁷³ 7786-16 ⁷³	995-16 ² 26995-16 ²	740-16 795-16	611-16 614-16	503-16 ²	621-16	N/A	451	4051
863-16 ^{37,45}	3112	1452-16 19061-16 ^{1,47}	7262-16 ⁷³ 7786-16 ⁷³	995-16 ² 26995-16 ²	740-16 795-16	611-16 614-16	503-16 ²	621-16	N/A	451	4051
863-16 ^{37,45}	3112	1452-16 19061-16 ^{1,47}	7262-16 ⁷³ 7786-16 ⁷³	995-16 ² 26995-16 ²	740-16 795-16	611-16 614-16	503-16 ²	621-16	N/A	451	4051

K-KIT	SK-KIT	CL-KIT	RP-KIT	LIFTERS	TIMING SET	ROCKER ARMS	PUSHRODS	VALVE SPRINGS	RETAINERS	VALVE LOCKS	VALVE SEALS
XTREME ENERGY™ Retro-Fit Hydraulic Roller Camshafts											
K51-413-9 ⁵	SK51-413-9 ^{5,7}	CL51-413-9 ^{5,7}	N/A	857-16	2112 3112	1451-16 ^{1,47} 19060-16 ^{1,47}	7775-16	995-16 ² 26995-16 ²	740-16 795-16	611-16 614-16	503-16 ²
K51-423-9 ⁵	SK51-423-9 ^{5,7}	CL51-423-9 ^{5,7}	N/A	857-16	2112 3112	1451-16 ^{1,47} 19060-16 ^{1,47}	7775-16	995-16 ² 26995-16 ²	740-16 795-16	611-16 614-16	503-16 ²
K51-433-9 ⁵	SK51-433-9 ^{5,7}	CL51-433-9 ^{5,7}	N/A	857-16	2112 3112	1451-16 ^{1,47} 19060-16 ^{1,47}	7775-16	995-16 ² 26995-16 ²	740-16 795-16	611-16 614-16	503-16 ²

⁴⁵ 265-301 use Part #864-16
⁴⁷ 1.65:1 ratio available

⁷³ Fits only 350-455

PONTIAC 265-455 C.I. 8 CYL. 1955-1981 (CONTINUED)

APPLICATIONS/CAMSHAFTS	VALVE SETTING		RPM OPERATING RANGE	CAM PART #	CAM GRIND #	DURATION				VALVE LIFT		LOBE SEP. ANGLE
	IN.	EX.				ADVERTISED IN.	EX.	@ .050" IN.	EX.	W/ 1.5 ROCKER IN.	EX.	
THUMPR™ Retro-Fit Hydraulic Roller Camshafts												
HYDRAULIC ROLLER – Thumpr™ – High performance street, stock converter ok, best with 2000+ converter and gears, choppy/thumping idle.	Hyd.	Hyd.	1700 to 5500	51-600-9⁵	283THR7	283	303	227	241	.513	.498	107°
HYDRAULIC ROLLER – Mutha' Thumpr™ – High performance street/strip, needs 9:1 compression, 2500+ stall, intake, gears and headers, rough idle.	Hyd.	Hyd.	2000 to 5800	51-601-9⁵	291THR7	291	311	235	249	.522	.508	107°
HYDRAULIC ROLLER – Big Mutha' Thumpr™ – Street/strip, needs 9.5:1 compression, 2800+ stall, intake, gears and headers, very rough idle.	Hyd.	Hyd.	2300 to 6100	51-602-9⁵	299THR7	299	319	243	257	.532	.519	107°
MAGNUM Mechanical Flat Tappet Camshafts												
SOLID – Good idle, strong mid-range torque. Excellent cam for mild street engines.	.022	.022	1800 to 5800	51-244-4	270S	270	270	224	224	.468	.468	110°
SOLID – Mild idle, street machine cam. Needs 9.5:1+ compression, 2000+ stall and headers.	.022	.022	2000 to 6000	51-245-4	282S	282	282	236	236	.495	.495	110°
SOLID – Rough idle, needs 10:1+ compression ratio. Maximum street performance. Use 3000+ stall and low gear.	.022	.022	2500 to 6500	51-246-4	294S	294	294	248	248	.525	.525	110°
SOLID – Race idle, Pro Street. Needs 10.5:1+ compression and 3500+ stall. Limited street use.	.022	.022	3000 to 6500	51-247-4	306S	306	306	260	260	.555	.555	110°

APPLICATIONS/CAMSHAFTS	VALVE SETTING		RPM OPERATING RANGE	CAM PART #	CAM GRIND #	DURATION				VALVE LIFT		LOBE SEP. ANGLE
	IN.	EX.				ADVERTISED IN.	EX.	@ .050" IN.	EX.	W/ 1.5 ROCKER IN.	EX.	
DRAG RACE Mechanical Flat Tappet Camshafts												
SOLID – Super torque, 3500+ stall, works well in heavy car.	.026	.028	3500 to 6500	51-659-5	290B-6	290	304	255	266	.540	.540	106°
SOLID – Excellent for 400-455, good torque. 4200+ stall.	.026	.028	4200 to 6500	51-660-5	300B-6	300	314	265	276	.562	.556	106°

APPLICATIONS/CAMSHAFTS	VALVE SETTING		RPM OPERATING RANGE	CAM PART #	CAM GRIND #	DURATION				VALVE LIFT		LOBE SEP. ANGLE
	IN.	EX.				ADVERTISED IN.	EX.	@ .050" IN.	EX.	W/ 1.5 ROCKER IN.	EX.	
MAGNUM Mechanical Roller Camshafts												
MECHANICAL ROLLER – Choppy idle, broad power range, increased compression, 3000+ stall, headers and lower gears.	.020	.020	2200 to 6500	51-751-9⁵	288R	288	288	243	243	.550	.550	110°
MECHANICAL ROLLER – Rough idle, maximum street effort. 10.5:1+ compression, 3500+ stall.	.020	.020	3000 to 6700	51-752-9⁵	308R	308	308	262	262	.575	.575	110°

¹ Requires screw-in studs & guide plates

² Requires machining on cylinder heads

⁵ Requires distributor gear upgrade

⁷ Stock springs cannot be used

⁸ Fits only certain years

³⁷ Adjustable valve train required

⁴⁶ Must use bronze tip fuel pump pushrod when using high pressure or high volume pump

⁴⁷ 1.65:1 ratio available

PONTIAC 265-455 C.I. 8 CYL. 1955-1981 (CONTINUED)

CAMSHAFTS GENERAL MOTORS

K-KIT	SK-KIT	CL-KIT	RP-KIT	LIFTERS	TIMING SET	ROCKER ARMS	PUSHRODS	VALVE SPRINGS	RETAINERS	VALVE LOCKS	VALVE SEALS
-------	--------	--------	--------	---------	------------	-------------	----------	---------------	-----------	-------------	-------------

THUMPR™ Retro-Fit Hydraulic Roller Camshafts

K51-600-9 ⁵	N/A	CL51-600-9 ^{5,7}	N/A	857-16	2112 3112	1451-16 ⁴⁷ 19060-16 ^{1,47}	7775-16 ^{51,66}	995-16 ² 26995-16 ²	740-16 795-16	611-16 614-16	503-16 ²
K51-601-9 ⁵	N/A	CL51-601-9 ^{5,7}	N/A	857-16	2112 3112	1451-16 ⁴⁷ 19060-16 ^{1,47}	7775-16 ^{51,66}	995-16 ² 26995-16 ²	740-16 795-16	611-16 614-16	503-16 ²
K51-602-9 ⁵	N/A	CL51-602-9 ^{5,7}	N/A	857-16	2112 3112	1451-16 ⁴⁷ 19060-16 ^{1,47}	7775-16 ^{51,66}	995-16 ² 26995-16 ²	740-16 795-16	611-16 614-16	503-16 ²

MAGNUM Mechanical Flat Tappet Camshafts

K51-244-4	SK51-244-4 ⁷	CL51-244-4 ⁷	N/A	2900-16 ³⁷	2112 3112	1451-16 ⁴⁷ 19060-16 ^{1,47}	7263-16 ⁸ 7789-16 ⁸	995-16 ² 26995-16 ²	740-16 795-16	611-16 614-16	503-16 ²
K51-245-4	SK51-245-4 ⁷	CL51-245-4 ⁷	N/A	2900-16 ³⁷	2112 3112	1451-16 ⁴⁷ 19060-16 ^{1,47}	7263-16 ⁸ 7789-16 ⁸	995-16 ² 26995-16 ²	740-16 795-16	611-16 614-16	503-16 ²
K51-246-4	SK51-246-4 ⁷	CL51-246-4 ⁷	N/A	2900-16 ³⁷	2112 3112	1451-16 ⁴⁷ 19060-16 ^{1,47}	7263-16 ⁸ 7789-16 ⁸	995-16 ² 26995-16 ²	740-16 795-16	611-16 614-16	503-16 ²
K51-247-4	SK51-247-4 ⁷	CL51-247-4 ⁷	N/A	2900-16 ³⁷	2112 3112	1451-16 ⁴⁷ 19060-16 ^{1,47}	7263-16 ⁸ 7789-16 ⁸	995-16 ² 26995-16 ²	740-16 795-16	611-16 614-16	503-16 ²

LIFTERS	TIMING SET	ROCKER ARMS	PUSHRODS	VALVE SPRINGS	RETAINERS	VALVE LOCKS	VALVE SEALS	LASH CAPS	REV KIT	DIST. GEAR	STUD GIRDLES
---------	------------	-------------	----------	---------------	-----------	-------------	-------------	-----------	---------	------------	--------------

DRAG RACE Mechanical Flat Tappet Camshafts

2900-16 ³⁷	3112	19060-16 ^{1,47}	7263-16 ⁷³ 7789-16 ⁷³	995-16 ² 26995-16 ²	740-16 795-16	611-16 614-16	503-16 ²	621-16	N/A	451	4051
2900-16 ³⁷	3112	19060-16 ^{1,47}	7263-16 ⁷³ 7789-16 ⁷³	995-16 ² 26995-16 ²	740-16 795-16	611-16 614-16	503-16 ²	621-16	N/A	451	4051

K-KIT	SK-KIT	CL-KIT	RP-KIT	LIFTERS	TIMING SET	ROCKER ARMS	PUSHRODS	VALVE SPRINGS	RETAINERS	VALVE LOCKS	VALVE SEALS
-------	--------	--------	--------	---------	------------	-------------	----------	---------------	-----------	-------------	-------------

MAGNUM Mechanical Roller Camshafts

K51-751-9 ⁵	SK51-751-9 ^{5,7}	CL51-751-9 ^{5,7}	N/A	859-16 ³⁷	2112 3112	19060-16 ^{1,47}	7262-16 7789-16	914-16 ² 26112-16 ²	741-16 729-16	611-16	503-16 ²
K51-752-9 ⁵	SK51-752-9 ^{5,7}	CL51-752-9 ^{5,7}	N/A	859-16 ³⁷	2112 3112	19060-16 ^{1,47}	7262-16 7789-16	914-16 ² 26112-16 ²	741-16 729-16	611-16	503-16 ²

⁵¹ Pushrod length may vary depending on combination, check for proper length

⁶⁶ For 455 use Part #7783-16

⁷³ Fits only 350-455

HARLEY DAVIDSON BIG TWIN EVOLUTION 1984-2006

APPLICATIONS/CAMSHAFTS	RPM OPERATING RANGE	CAM PART #	DURATION @ .053"		VALVE LIFT W/ 1.625 ROCKER		LOBE SEPERATION ANGLE
			IN.	EX.	IN.	EX.	
XTREME ENERGY™ Hydraulic Roller Camshafts							
HYDRAULIC ROLLER – Excellent low end and mid-range power from idle up. Great for two up riding or pulling a trailer.	1000 to 5300	EVL-5000⁸⁵	230	230	.562	.562	102
HYDRAULIC ROLLER – Strong low end and mid-range power for heavy bikes. Good on highway.	1500 to 5500	EVL-5005⁸⁵	236	236	.569	.569	102
HYDRAULIC ROLLER – Increased mid and upper end power for lighter bikes. Stock heads with spring change ok.	1800 to 5800	EVL-5010⁸⁵	244	244	.585	.585	103
HYDRAULIC ROLLER – Great mid and upper end power in modified 80-88c.i. Increased compression, pipes, and carb work.	2200 to 6200	EVL-5015⁸⁵	252	252	.585	.585	103
HYDRAULIC ROLLER – 88c.i. and up, 10:1 compression, performance carb/exhaust. Good power in light bike.	2500 to 6500	EVL-5020⁸⁵	260	260	.585	.585	104
HYDRAULIC ROLLER – For serious power in 88c.i. and up, 10.5:1 compression, head work, performance exhaust, and carb.	2800 to 6800	EVL-5025⁸⁵	268	272	.601	.601	105
MAGNUM Hydraulic Roller Camshafts							
HYDRAULIC ROLLER – Excellent bolt-in cam for stock upgrade. Good flat torque curve with more power than stock.	800 to 4800	EVL-2000⁸⁵	220	214	.480	.456	108
HYDRAULIC ROLLER – Bolt-in cam with good low and mid-range power for fuel injected bangers.	1200 to 5200	EVL-2015⁸⁵	224	234	.500	.500	103
HYDRAULIC ROLLER – Bolt-in cam with good low end torque for heavy bikes, two up riding, or trailer pulling.	1500 to 5500	EVL-3000⁸⁵	224	224	.500	.500	102
HYDRAULIC ROLLER – Good stock replacement for 80c.i. engines. Good low end torque and mid-range in heavy or light bikes.	1500 to 5800	EVL-3010⁸⁵	234	234	.500	.500	102
HYDRAULIC ROLLER – Bolt-in for 80c.i. engines, strong mid-range and upper end power with stock heads.	1800 to 6000	EVL-3020⁸⁵	240	240	.500	.500	102
HYDRAULIC ROLLER – Good in 80-88c.i. engines with up to 10:1 compression. More mid-range and upper end power.	2000 to 6300	EVL-3030⁸⁵	240	240	.530	.530	104
HYDRAULIC ROLLER – Split duration cam for light bikes with 80-88c.i. engines, with more mid and upper end power than the 3030.	2500 to 6500	EVL-3040⁸⁵	242	252	.510	.510	104
HYDRAULIC ROLLER – Good performance cam in light bikes. Pulls hard in upper end. Likes pipes, carb, and 9:1 compression.	3000 to 7000	EVL-3050⁸⁵	252	252	.510	.510	104
HYDRAULIC ROLLER – Hot street/strip cam. Pipes, carb, and 10:1+ compression. Needs 88c.i. and larger engines.	3000 to 7000+	EVL-3060⁸⁵	260	270	.585	.585	106
HYDRAULIC ROLLER – Serious cam for top end power. Needs good heads, pipes and carb. Best 88c.i. and larger engine with 11:1+ compression.	3200 to 7500	EVL-3070⁸⁵	270	274	.608	.608	106

⁸⁵ For a camshaft w/ NO timing gear, simply add NG to the end of the part #

⁸⁶ P-Kit contains cam, pushrods and camshaft bearing

⁸⁷ SP-Kit contains cam, pushrods, camshaft bearing, springs, locks, retainers & seats

⁸⁸ SP+Kit is an upgrade of the SP-Kit

⁹¹ Use Part #7002S for stroker engines & Part #7002R for engines using stock lifters

HARLEY DAVIDSON BIG TWIN EVOLUTION 1984-2006

CAMSHAFTS HARLEY DAVIDSON

P-KIT	SP KIT	SP+ KIT	PUSHRODS	BEEHIVE™ SPRING KITS	SPRING KITS	VALVE SPRINGS	RETAINERS	VALVE LOCKS	SPRING SEATS
XTREME ENERGY™ Hydraulic Roller Camshafts									
EVL-5000P ⁸⁶	EVL-5000SP ⁸⁷	EVL-5001SP ⁸⁸	7002-KIT ⁹¹	9708-KIT ⁹²	9702-KIT ⁹²	VT908-4	749-4	618-4	4784-4
EVL-5005P ⁸⁶	EVL-5005SP ⁸⁷	EVL-5006SP ⁸⁸	7002-KIT ⁹¹	9708-KIT ⁹²	9702-KIT ⁹²	VT908-4	749-4	618-4	4784-4
EVL-5010P ⁸⁶	EVL-5010SP ⁸⁷	EVL-5011SP ⁸⁸	7002-KIT ⁹¹	9708-KIT ⁹²	9702-KIT ⁹²	VT908-4	749-4	618-4	4784-4
EVL-5015P ⁸⁶	EVL-5015SP ⁸⁷	EVL-5016SP ⁸⁸	7002-KIT ⁹¹	9708-KIT ⁹²	9702-KIT ⁹²	VT908-4	749-4	618-4	4784-4
EVL-5020P ⁸⁶	EVL-5020SP ⁸⁷	EVL-5021SP ⁸⁸	7002-KIT ⁹¹	9708-KIT ⁹²	9702-KIT ⁹²	VT908-4	749-4	618-4	4784-4
EVL-5025P ⁸⁶	EVL-5025SP ⁸⁷	EVL-5026SP ⁸⁸	7002-KIT ⁹¹	9708-KIT ⁹²	9801-KIT ⁹² 9706-KIT	927-4 26095-4	732-4 785-4	618-4	4770-4 4711-4
MAGNUM Mechanical Flat Tappet Camshafts									
N/A	N/A	N/A	7002-KIT ⁹¹	9708-KIT ⁹²	9700-KIT ⁹²	977-4	740-4	618-4	4770-4
N/A	N/A	N/A	7002-KIT ⁹¹	9708-KIT ⁹²	9700-KIT ⁹²	977-4	740-4	618-4	4770-4
EVL-3000P ⁸⁶	EVL-3000SP ⁸⁷	EVL-3001SP ⁸⁸	7002-KIT ⁹¹	9708-KIT ⁹²	9700-KIT ⁹² 9704-KIT ⁹²	977-4 26120-4	740-4 795-4	618-4	4770-4 4696-4
EVL-3010P ⁸⁶	EVL-3010SP ⁸⁷	EVL-3011SP ⁸⁸	7002-KIT ⁹¹	9708-KIT ⁹²	9700-KIT ⁹² 9704-KIT ⁹²	977-4 26120-4	740-4 795-4	618-4	4770-4 4696-4
EVL-3020P ⁸⁶	EVL-3020SP ⁸⁷	EVL-3021SP ⁸⁸	7002-KIT ⁹¹	9708-KIT ⁹²	9700-KIT ⁹² 9704-KIT ⁹²	977-4 26120-4	740-4 795-4	618-4	4770-4 4696-4
EVL-3030P ⁸⁶	EVL-3030SP ⁸⁷	EVL-3031SP ⁸⁸	7002-KIT ⁹¹	9708-KIT ⁹²	9700-KIT ⁹² 9704-KIT ⁹²	VT908-4 26120-4	749-4 795-4	618-4	4770-4 4696-4
EVL-3040P ⁸⁶	EVL-3040SP ⁸⁷	EVL-3041SP ⁸⁸	7002-KIT ⁹¹	9708-KIT ⁹²	9700-KIT ⁹² 9704-KIT ⁹²	VT908-4 26120-4	749-4 795-4	618-4	4770-4 4696-4
EVL-3050P ⁸⁶	EVL-3050SP ⁸⁷	EVL-3051SP ⁸⁸	7002-KIT ⁹¹	9708-KIT ⁹²	9700-KIT ⁹² 9704-KIT ⁹²	VT908-4 26120-4	749-4 795-4	618-4	4770-4 4696-4
EVL-3060P ⁸⁶	EVL-3060SP ⁸⁷	EVL-3061SP ⁸⁸	7002-KIT ⁹¹	9708-KIT ⁹² 9709-KIT ⁹²	9801-KIT ⁹² 9706-KIT ⁹²	927-4 26095-4	732-4 785-4	618-4	4770-4 4711-4
EVL-3070P ⁸⁶	EVL-3070SP ⁸⁷	EVL-3071SP ⁸⁸	7002-KIT ⁹¹	9708-KIT ⁹² 9709-KIT ⁹²	9801-KIT ⁹² 9706-KIT ⁹²	927-4 26095-4	732-4 785-4	618-4	4770-4 4711-4

⁹² Spring kit includes springs, retainers, locks & spring seats



HONDA D16Z6 1.6 LITER SOHC 4 CYL. W/ VTEC 1992-1995 CIVIC EX, 1993-1995 DEL SOL SI

APPLICATIONS/CAMSHAFTS	VALVE SETTING		RPM OPERATING RANGE	CAM PART #	CAM GRIND #	DURATION				VALVE LIFT		CENTERLINE	
						ADVERTISED		@ .050"					
	IN.	EX.				IN.	EX.	IN.	EX.	IN.	EX.	IN.	EX.
QUIKTYME™ Solid Swinging Follower Camshafts													
SERIOUS STREET – Great street cam for increased power and torque with efficiency. Works with stock components.	.007	.009	2000 to 6700	59100	256 VTEC	256	252	215	211	.441	.401	103°	111°
SEVERE STREET/RACE – Best performance cam available. Large increases above stock cam from off idle to the rev limiter. Excellent high RPM power.	.007	.009	2000 to 7200	59300	260 VTEC	256	268	220	216	.456	.428	107°	111°

Valve springs (#912-16) and retainers (#753-16) available for these engines.

HONDA/ACURA TWIN CAM VTEC B16A, B17A, B18C, B18C5 1992-2000

APPLICATIONS/CAMSHAFTS	VALVE SETTING		RPM OPERATING RANGE	CAM PART #	CAM ID	DURATION					
						ADVERTISED			@ .050"		
	IN.	EX.				VTEC	PRI.	SEC.	VTEC	PRI.	SEC.
QUIKTYME™ Solid Swinging Follower Camshafts (Turbo Grinds Also Available)											
SERIOUS STREET – Great street cam for increased power and torque with efficiency. Works with stock components.	.007	.009	2000 to 8200	57100	INTAKE	260	252	240	220	210	194
					EXHAUST	266	256	240	222	210	194
SERIOUS STREET/RACE – Best performance cam available. Large increases above stock cam from off idle to the rev limiter. Excellent high RPM power.	.007	.009	2400 to 8600	57200	INTAKE	278	256	244	238	214	198
					EXHAUST	284	260	244	240	214	198
SEVERE STREET/RACE – Excellent mid-range to top end power for serious performers. Excellent high RPM power.	.007	.009	2600 to 9000	57300	INTAKE	290	260	248	250	218	202
					EXHAUST	296	264	248	252	218	202
SEVERE STREET/COMPETITION – Great top end power for radical street or race applications.	.007	.009	2800 to 9200	57400	INTAKE	300	260	260	260	222	222
					EXHAUST	306	264	264	262	222	222

INTERNATIONAL HARVESTER 304-392 C.I. 8 CYL. 1970-1978

APPLICATIONS/CAMSHAFTS	VALVE SETTING		RPM OPERATING RANGE	CAM PART #	CAM GRIND #	DURATION				VALVE LIFT		LOBE SEP. ANGLE
						ADVERTISED		@ .050"		W/ 1.5 ROCKER		
	IN.	EX.				IN.	EX.	IN.	EX.	IN.	EX.	
HIGH ENERGY™ Hydraulic Flat Tappet Camshafts												
HYDRAULIC – Low end power, strong torque, good mileage, best for 304 with stock transmission.	Hyd.	Hyd.	800 to 4500	83-200-4	252H	252	252	206	206	.425	.425	110°
HYDRAULIC – Best cam for towing, hauling and heavy-duty usage, lots of torque.	Hyd.	Hyd.	1000 to 5000	83-201-4	260H	260	260	212	212	.440	.440	110°
HYDRAULIC – High performance cam. Best in large engine with manual transmission. Noticeable idle.	Hyd.	Hyd.	1200 to 5200	83-202-4	268H	268	268	218	218	.454	.454	110°

HONDA D16Y8 1.6L SOHC 4 CYL. W/ VTEC 1996-2000

APPLICATIONS/CAMSHAFTS	VALVE SETTING		RPM OPERATING RANGE	CAM PART #	CAM GRIND #	DURATION				VALVE LIFT		CENTERLINE	
	IN.	EX.				ADVERTISED		@ .050"		IN.	EX.	IN.	EX.
						IN.	EX.	IN.	EX.				
QUIKTYME™ Solid Swinging Follower Camshafts													
SERIOUS STREET/RACE – Great street cam for increased power and torque with efficiency. Works with stock components.	.007	.009	2000 to 6700	105100	256 VTEC	256	252	215	211	.441	.401	103	111
SEVERE STREET/COMPETITION – Best performance cam available. Large increases above stock cam from off idle to the rev limiter. Excellent high RPM power. Requires spring #912-16.	.007	.009	2000 to 7200	105300	260 VTEC	256	268	220	216	.456	.428	107	111

Valve springs (#912-16) and retainers (#753-16) available for these engines.

HONDA/ACURA TWIN CAM VTEC B16A, B17A, B18C, B18C5 1992-2000

LOBE LIFT			VALVE LIFT			CENTERLINE			VALVE SPRINGS	RETAINERS		VALVE SPRING KITS
VTEC	PRI.	SEC.	VTEC	PRI.	SEC.	VTEC	PRI.	SEC.		STEEL	TITANIUM	
QUIKTYME™ Solid Swinging Follower Camshafts (Turbo Grinds Also Available)												
.310	.237	.186	.435	.360	.270	100°	112°	114°	913-SET	778-16	760-16	89000-16
.297	.230	.186	.390	.350	.270	106.5°	112°	110°				89012-16
.316	.250	.186	.490	.380	.270	100°	112°	114°	913-SET	778-16	760-16	89000-16
.304	.243	.186	.450	.370	.270	108°	112°	110°				89012-16
.322	.263	.186	.510	.400	.270	102°	112°	114°	913-SET	778-16	760-16	89000-16
.310	.257	.186	.470	.390	.270	110°	112°	110°				89012-16
.321	.266	.246	.496	.404	.374	97°	97°	97°	913-SET	778-16	760-16	89000-16
.302	.261	.241	.467	.395	.355	111°	111°	111°				89012-16

INTERNATIONAL HARVESTER 304-392 C.I. 8 CYL. 1970-1978

K-KIT	SK-KIT	CL-KIT	RP-KIT	LIFTERS	TIMING SET	ROCKER ARMS	PUSHRODS	VALVE SPRINGS	RETAINERS	VALVE LOCKS	VALVE SEALS
HIGH ENERGY™ Hydraulic Flat Tappet Camshafts											
K83-200-4	SK83-200-4	CL83-200-4	N/A	855-16	3225	N/A	N/A	961-16	N/A	603-16	504-16
K83-201-4	SK83-201-4	CL83-201-4	N/A	855-16	3225	N/A	N/A	961-16	N/A	603-16	504-16
K83-202-4	SK83-202-4 ⁷	CL83-202-4 ⁷	N/A	855-16	3225	N/A	N/A	961-16	N/A	603-16	504-16

⁷ Stock springs cannot be used

RED NUMBERS DENOTE PREMIUM OPTION

MITSUBISHI 4G63 2.0L DOHC 4 CYL. 1989-1999

APPLICATIONS/CAMSHAFTS	VALVE SETTING		RPM OPERATING RANGE	CAM PART #	CAM GRIND #	DURATION				VALVE LIFT		CENTERLINE	
	IN.	EX.				ADVERTISED		@ .050"		IN.	EX.	IN.	EX.
						IN.	EX.	IN.	EX.				
QUIKTYME™ Hydraulic Swinging Follower Camshafts (Custom Sets Available)													
SERIOUS STREET/RACE – Works w/ stock engine & turbo. Responds well to bolt-ons. Pulls strong throughout RPM band.	Hyd.	Hyd.	1800 to 6800	101100	XE251HR	251	250	204	204	.407	.391	104°	108°
SEVERE STREET/COMPETITION – Bigger turbo, manual transmission or automatic with 3000+ stall. Stronger mid to upper RPM.	Hyd.	Hyd.	2600 to 7500	101200	XE259HR	259	258	212	212	.411	.395	107.5	111.5
SEVERE STREET/COMPETITION – Works well with stroked engine and stock turbo. Responds well to bolt-ons. Pulls strong throughout RPM band.	Hyd.	Hyd.	2400 to 7300	101300	XE258HR	258	258	212	212	.411	.395	102°	111°
SEVERE STREET/COMPETITION – Works well with stroked engine w/ bigger turbo, manual transmission, or automatic w/ 3000+ stall. Stronger mid to upper RPM.	Hyd.	Hyd.	3000 to 7800	101400	XE266HR	266	266	220	220	.415	.399	104°	107°

MITSUBISHI 4G63 EVOLUTION VIII 2.0L DOHC 4 CYL. 2003-2005

APPLICATIONS/CAMSHAFTS	VALVE SETTING		RPM OPERATING RANGE	CAM PART #	CAM GRIND #	DURATION				VALVE LIFT		CENTERLINE	
	IN.	EX.				ADVERTISED		@ .050"		IN.	EX.	IN.	EX.
						IN.	EX.	IN.	EX.				
QUIKTYME™ Hydraulic Swinging Follower Camshafts (Custom Sets Available)													
SERIOUS STREET/RACE – 264+c.i. works well w/ stock engine & turbo. Responds well to bolt-ons. Pulls strong throughout RPM band.	Hyd.	Hyd.	1800 to 6800	119100	XE248HR	248	249	202	202	.434	.411	104°	112°
SEVERE STREET/COMPETITION – 272+c.i. works well w/ upgraded turbos & higher boost levels. Stronger mid to upper RPM.	Hyd.	Hyd.	2600 to 7500	119200	XE256HR	256	257	210	210	.434	.411	104°	112°
SEVERE STREET/COMPETITION – 280+c.i. Excellent for big turbos, high boost levels, & ported heads. Maximum upper RPM horsepower.	Hyd.	Hyd.	3000 to 7800	119300	XE264HR	264	285	218	218	.434	.411	104°	112°

Note: When replacing stock rotators check installed height.

NISSAN Z20, Z22, Z24 4 CYL. 1981-1989

APPLICATIONS/CAMSHAFTS	VALVE SETTING		RPM OPERATING RANGE	CAM PART #	CAM GRIND #	DURATION				VALVE LIFT		LOBE SEP. ANGLE
						ADVERTISED		@ .050"				
	IN.	EX.				IN.	EX.	IN.	EX.	IN.	EX.	
HIGH ENERGY™ Solid Swinging Follower Camshafts												
SOLID – Good cam to replace OEM grinds. Improved torque and power. Best in low RPM.	.010	.010	800 to 4500	88-119-6	252S	252	252	208	208	.422	.422	110°
SOLID – High performance cam for street driving. Good power in mid-range.	.010	.010	1000 to 4800	88-123-6	260S	260	260	214	214	.420	.420	110°

NISSAN 2400-2800CC 6 CYL. 1970-1984

APPLICATIONS/CAMSHAFTS	VALVE SETTING		RPM OPERATING RANGE	CAM PART #	CAM GRIND #	DURATION				VALVE LIFT		LOBE SEP. ANGLE
						ADVERTISED		@ .050"				
	IN.	EX.				IN.	EX.	IN.	EX.	IN.	EX.	
HIGH ENERGY™ Solid Swinging Follower Camshafts												
SOLID – Power & torque improvement over stock cam.	.008	.008	500 to 4500	84-115-6	240S	240	240	194	194	.400	.400	110°
SOLID – Better torque and power than OEM cam, but smooth and efficient. Smooth idle.	.008	.008	800 to 4800	84-119-6	252S	252	252	204	204	.410	.410	110°
SOLID – Street performance. Smooth idle. Wide powerband.	.010	.010	1000 to 5000	84-123-6	260S	260	260	214	214	.420	.420	110°

TOYOTA 20R AND 22R 4 CYL. 1974-1989

APPLICATIONS/CAMSHAFTS	VALVE SETTING		RPM OPERATING RANGE	CAM PART #	CAM GRIND #	DURATION				VALVE LIFT		LOBE SEP. ANGLE
						ADVERTISED		@ .050"				
	IN.	EX.				IN.	EX.	IN.	EX.	IN.	EX.	
HIGH ENERGY™ Solid Swinging Follower Camshafts												
SOLID – Smooth torque and economy. Best cam to replace OEM grind. Very smooth idle.	.010	.010	800 to 4500	87-119-6⁹⁹	252S	255	255	214	214	.420	.420	110°
SOLID – Excellent cam for trucks. Good torque for heavy-duty use. Smooth idle.	.010	.010	1000 to 4800	87-123-6⁹⁹	260S	263	263	222	222	.440	.440	110°
SOLID – Performance use. Wide powerband. Smooth idle.	.010	.010	1500 to 5500	87-127-6⁹⁹	268S	271	271	230	230	.445	.445	110°
MAGNUM Solid Swinging Follower Camshafts												
SOLID – Best cam for street performance with 5-speed. Good mid-range and top end.	.010	.010	2000 to 6000	87-131-6⁹⁹	280S	283	283	242	242	.455	.455	110°

⁹⁹ Will not work in fuel injected applications



APPLICATIONS/CAMSHAFTS	PART #	GRIND #	DURATION IN DEGREES				VALVE LIFT		LOBE SEPARATION ANGLE
			ADVERTISED		@ .050"		IN	EX.	
			IN	EX.	IN	EX.			
AMC 2.5L 1980-1983			CUSTOM GRINDS AVAILABLE (114-000-5)						
BUICK STAGE II EVEN FIRE 6 CYL. 1978-1988			CUSTOM GRINDS AVAILABLE						
ROLLER	93-850-9	296-R4	296-7	300-7	264	268	.650	.650	104°
ROLLER	93-902-9	312-R6	312-5	312-5	276	276	.672	.672	106°
BUICK 215 ALUMINUM V8 1961-1963			CUSTOM GRINDS AVAILABLE (90-000-5)						
BUICK 364, 401, 425 V8 1957-1965			CUSTOM GRINDS AVAILABLE (91-000-5)						
CHEVROLET CHEVETTE 1400CC 1976-1977 & 1600CC 1976-1987			CUSTOM GRINDS AVAILABLE (77-000-5)						
CHEVROLET 235 L6 BLUE FLAME 1952-1962			CUSTOM GRINDS AVAILABLE (60-000-5)						
CHEVROLET 292 L6 1963-1990			CUSTOM GRINDS AVAILABLE (62-000-5)						
CHEVROLET V6 ODD FIRE RACE ENGINE			CUSTOM GRINDS AVAILABLE						
ROLLER	17-900-9	288AR-4	288-8	300-5	260	264	.660	.630	104°
ROLLER	17-901-9	292AR-5	292-8	304-5	264	268	.660	.630	105°
CHEVROLET V6 ODD FIRE w/ SPLAYED VALVE HEAD			CUSTOM GRINDS AVAILABLE (02-000-9)						
CHEVROLET V8 262-400 1957-1998 W/ 1.5 ROCKERS			CUSTOM GRINDS AVAILABLE						
HYDRAULIC	12-204-4 ⁴⁹	244H-10	244-2	244-2	196	196	.400	.400	110°
HYDRAULIC	12-306-4 ⁴⁹	252AH-8	252-4	260-7	206	212	.425	.440	108°
HYDRAULIC	12-308-4 ⁴⁹	252AH-10	252-4	260-7	206	212	.425	.440	110°
HYDRAULIC	12-310-4 ⁴⁹	260AH-8	260-9	268-9	212	218	.444	.444	108°
HYDRAULIC	12-312-4 ⁴⁹	260AH-10	260-9	268-9	212	218	.444	.444	110°
HYDRAULIC	12-316-4	268H-8	268-4	268-4	222	222	.464	.464	108°
HYDRAULIC	12-319-4	268AH-8	268-4	276-4	222	226	.464	.464	108°
HYDRAULIC	12-320-4	270AH-10	270-4	280-3	224	230	.470	.460	110°
HYDRAULIC	12-321-4	270AH-8	270-4	280-3	224	230	.470	.460	108°
HYDRAULIC	12-328-4	286AH-10	286-3	292-3	236	244	.490	.485	110°
HYDRAULIC	12-334-4	292AH-8	292-2	296-3	244	246	.501	.510	108°
HYDRAULIC	12-336-4	292AH-10	292-2	296-3	244	246	.501	.510	110°
HYDRAULIC	12-338-4	296H-10	296-3	296-3	246	246	.510	.510	110°
HYDRAULIC	12-346-4	305H-8	305-2	305-2	253	253	.525	.525	108°
HYDRAULIC	12-348-4	305AH-8	305-2	312-6	253	260	.525	.530	108°
HYDRAULIC	12-352-4	312H-8	312-5	312-5	260	260	.540	.540	108°
HYDRAULIC	12-354-4	312H-10	312-5	312-5	260	260	.540	.540	110°
HYDRAULIC	12-353-4	312AH-8	312-5	320-5	260	268	.540	.540	108°
HYDRAULIC	12-356-4	312AH-10	312-5	320-5	260	268	.540	.540	110°
HYDRAULIC	12-216-5	320H-10	320-10	328-8	270	276	.551	.551	110°
HYDRAULIC	12-362-4	328H-8	328-8	328-8	276	276	.551	.551	108°
SOLID	12-220-5	270S-8	270-1	270-1	235	235	.495	.495	108°
SOLID	12-613-5	300B-8	300-1	314-1	265	276	.562	.557	108°
SOLID	12-619-5	310C-6	310-1	320-2	275	280	.585	.562	106°
SOLID	12-615-5	314B-8	314-1	324-1	276	286	.557	.578	108°
SOLID	12-635-5	328B-9	328-3	334-2	290	296	.600	.600	109°
.875" DIAMETER LIFTER	12-745-7	298Z-4	298-2	304-4	261	266	.555	.555	104°
.875" DIAMETER LIFTER	12-747-7	296Z-6	296XX	302XX	264	270	.593	.605	106°
.875" DIAMETER LIFTER	12-751-7	304NZ-6	304N-1	308XX	272	276	.615	.615	106°
ROLLER	12-707-8	288R-10	288-4	288-4	244	244	.550	.550	110°
ROLLER	12-723-9	295DR-6	295-3	305-2	262	272	.585	.550	106°
ROLLER - .900" B.C.	12-998-9	300B-6	300-5	308-6	264	270	.630	.630	106°
ROLLER	12-904-9	304AR-6	304-5	308-6	268	270	.630	.630	106°
ROLLER	12-913-9	296BR-6	296-8	308-5	268	272	.660	.630	106°
ROLLER	12-800-9	306A-6	306-1	306-1	270	270	.600	.600	106°
ROLLER - .900" B.C.	12-995-9	308AR-7	308-5	312-6	272	274	.630	.630	107°
ROLLER	12-710-9	313DR-2	313-6	316-6	276	278	.660	.630	102°
ROLLER - .900" B.C.	12-997-9	316AR-8	316-5	326-4	280	288	.630	.630	108°
ROLLER	12-810-9	312FR-4	312-8	312-8	284	284	.660	.660	104°
ROLLER	12-812-9	312GR-6	312-8	330-5	284	292	.660	.630	106°

⁴⁹ 50-State legal for 1987 & earlier carbureted V8 SB Chevrolet 262-400 C.A.R.B. E.O. #D-279-3, #D-279-5, #D-279-6

APPLICATIONS/CAMSHAFTS	PART #	GRIND #	DURATION IN DEGREES				VALVE LIFT		LOBE SEPARATION ANGLE
			ADVERTISED		@ .050"		IN	EX.	
			IN	EX.	IN	EX.			
ROLLER	12-816-9	324FR-6	324-6	332-2	284	292	.706	.630	106°
ROLLER	12-758-9	328AR-8	328-6	288-9	288	292	.684	.660	108°
ROLLER 1.968" BRNG	12-962-9	294RTR-6	RT294-1	304-5	264	268	.645	.630	106°
ROLLER 1.968" BRNG	12-964-9	298RTR-6	RT298-1	308-5	268	272	.653	.630	106°
CHEVROLET V8 262-400 1957-1998 REVERSE ROTATION			CUSTOM GRINDS AVAILABLE (12-000-5RR)						
CHEVROLET V8 262-400 V8 w/ SPLAYED VALVE, BUICK OR DART HEADS			CUSTOM GRINDS AVAILABLE						
ROLLER	19-901-9	318BR-12	318-6	330-5	278	292	.698	.630	112°
ROLLER	19-921-9	328DR-13	328-5	340-3	288	300	.714	.660	113°
ROLLER	19-935-9	324GR-12	324-7	336-5	284	296	.684	.660	112°
CHEVROLET V8 262-400 V8 w/ SPLAYED VALVE, BUICK OR DART HEADS			CUSTOM GRINDS AVAILABLE						
ROLLER	03-945-9	294ER-6	RT294-1	304-5	264	268	.645	.632	106°
ROLLER	03-955-9	300GR-7	RT300-1	308-7	270	276	.654	.609	107°
CHEVROLET SB2 HEAD & BLOCK WITH .875" TAPPETS AND 50MM JOURNALS			CUSTOM GRINDS AVAILABLE						
ROLLER	04-945-10	294AR-6	RT294-1	304-5	264	268	.645	.632	106°
ROLLER	04-955-10	300CR-7	RT300-1	308-7	270	276	.654	.609	107°
CHEVROLET 348-409 V8 1958-1965			CUSTOM GRINDS AVAILABLE (48-000-5 & 48-000-9)						
CHEVROLET V8 396-454 1965-1996 w/ 1.7 ROCKERS			CUSTOM GRINDS AVAILABLE						
HYDRAULIC	11-200-4	252BH-14	252-5	252-5	206	206	.460	.460	114°
HYDRAULIC	11-298-4	252AH-10	252-5	260-8	206	212	.460	.475	110°
HYDRAULIC	11-302-4	260AH-12	260-9	268-9	212	218	.503	.503	112°
HYDRAULIC	11-402-4	268AH-14	268-4	276-4	222	226	.525	.525	114°
HYDRAULIC	11-310-4	270AH-12	270-4	280-3	224	230	.532	.520	112°
HYDRAULIC	11-312-4	276AH-12	276-3	284-3	228	236	.537	.537	112°
HYDRAULIC	11-316-4	280AH-12	280-9	288-9	232	237	.547	.547	112°
HYDRAULIC	11-326-4	292AH-12	292-2	296-3	244	246	.567	.578	112°
HYDRAULIC	11-327-4	296H-10	296-3	296-3	246	246	.578	.578	110°
HYDRAULIC	11-328-4	296AH-10	296-3	305-4	246	253	.578	.575	110°
HYDRAULIC	11-334-4	305H-12	305-4	305-4	253	253	.575	.575	112°
HYDRAULIC	11-215-5	312H-10	312-6	312-6	260	260	.600	.600	110°
HYDRAULIC	11-340-4	312AH-10	312-6	320-9	260	268	.600	.600	110°
HYDRAULIC	11-345-5	320AH-14	320-5	328-8	268	276	.612	.625	114°
HYDRAULIC	11-216-5	320H-10	320-9	320-9	268	268	.600	.600	110°
SOLID	11-603-5	270A-8	270-1	280-1	235	242	.561	.575	108°
SOLID	11-612-5	310C-8	310-2	320-2	270	280	.638	.638	108°
SOLID	11-680-5	328B-12	328-3	334-2	290	296	.680	.680	112°
ROLLER	11-691-9	280A-R10	280-2	288-4	238	246	.623	.623	110°
ROLLER	11-707-9	295D-R8	295-3	305-2	264	274	.663	.622	108°
ROLLER	11-802-9	312JR-8	312-8	324-4	286	289	.748	.720	108°
ROLLER	11-722-9	328B-R14	328-5	344-5	288	304	.810	.782	114°
ROLLER	11-723-9	328CR-14	328-5	348-1	288	308	.810	.782	114°
ROLLER	11-714-9	316BR-10	316-15	327-5	284	290	.873	.782	110°
ROLLER	11-716-9	316AR-12	316-15	327-5	284	290	.873	.782	112°
GM 6.5L DIESEL			CUSTOM GRINDS AVAILABLE (117-000-9)						
CHRYSLER V8 273-360 1962-1997 w/ 1.5 ROCKERS			CUSTOM GRINDS AVAILABLE						
HYDRAULIC	20-201-4	244H-10	244-2	244-2	196	196	.400	.400	110°
HYDRAULIC	20-302-4	252AH-10	252-4	260-7	206	212	.425	.440	110°
HYDRAULIC	20-306-4	260AH-10	260-9	268-9	212	218	.444	.444	108°
HYDRAULIC	20-304-4	260AH-10	260-9	268-9	212	218	.444	.444	110°
HYDRAULIC	20-308-4	268H-8	268-4	268-4	222	222	.464	.464	108°
HYDRAULIC	20-309-4	268AH-10	268-4	276-4	222	226	.464	.464	110°
HYDRAULIC	20-311-4	270AH-10	270-4	280-3	224	230	.470	.480	110°
HYDRAULIC	20-316-4	280AH-8	280-9	288-9	232	237	.483	.483	108°
HYDRAULIC	20-318-4	286AH-8	286-3	292-2	236	244	.490	.501	108°
HYDRAULIC	20-321-4	292AH-10	292-2	296-3	244	246	.501	.510	110°

APPLICATIONS/CAMSHAFTS	PART #	GRIND #	DURATION IN DEGREES				VALVE LIFT		LOBE SEPARATION ANGLE
			ADVERTISED		@ .050"		IN	EX.	
			IN	EX.	IN	EX.			
HYDRAULIC	20-323-4	296H-8	296-3	296-3	246	246	.510	.510	108°
HYDRAULIC	20-324-4	296AH-8	296-3	305-2	246	253	.510	.525	108°
HYDRAULIC	20-328-4	305AH-8	305-2	312-5	253	260	.525	.540	108°
HYDRAULIC	20-245-5	312H-6	312-5	312-5	260	260	.540	.540	106°
SOLID	20-623-5	282XB-6	282XX	288XX	250	258	.556	.570	106°
SOLID	20-626-5	288XB-6	288XX	296XX	258	264	.570	.585	106°
SOLID	20-620-5	310A-6	310-1	310-1	275	275	.585	.585	106°
SOLID	20-622-5	330A-8	330-1	330-1	290	290	.615	.615	108°
ROLLER	20-700-9	276R-8	276-2	280-2	232	236	.525	.550	108°
ROLLER	20-752-9	288AR-6	288-5	296-6	252	258	.631	.630	106°
ROLLER	20-760-9	300AR-6	300-5	304-6	266	268	.630	.630	106°
ROLLER	20-758-9	306AR-6	306-1	306-1	270	270	.600	.600	106°
ROLLER	20-730-9	310CR-6	310-4	312-2	276	281	.627	.638	106°
ROLLER	20-712-9	312CR-6	312-5	312-2	276	281	.630	.638	106°
CHRYSLER V8 273-360 (w/ 48° BANK ANGLE AND 50MM JOURNALS)			CUSTOM GRINDS AVAILABLE						
ROLLER	20-713-9	290RX-6	RX290	RZ297	257	264	.644	.645	106°
ROLLER	20-714-9	294RX-6	RX294	RZ301	261	268	.647	.648	106°
ROLLER	20-715-9	300RX-8	RX300	RZ309	267	276	.651	.654	108°
DODGE R5 BLOCK w/ P7 HEADS			CUSTOM GRINDS AVAILABLE						
ROLLER	55-800-10	298RX-8	RX298	RZ305	265	272	.693	.694	108°
ROLLER	55-801-10	302RX-8	RX302	RZ311	269	278	.696	.699	108°
ROLLER	55-802-10	304RX-8	RX304	RZ317	271	284	.698	.704	108°
CHRYSLER V8 383-440 1958-1980 w/ 1.5 ROCKERS (21: SINGLE-BOLT CORE, 23: THREE-BOLT CORE)			CUSTOM GRINDS AVAILABLE						
HYDRAULIC	21-211-4	252BH	252-4	260-9	206	212	.425	.445	110°
HYDRAULIC	21-304-4	268H-8	268-4	268-4	222	222	.464	.464	108°
HYDRAULIC	21-310-4	286H-8	286-3	286-3	236	236	.490	.490	108°
HYDRAULIC	21-314-4	296H-8	296-3	296-3	246	246	.510	.510	108°
HYDRAULIC	21-318-4	312H-8	312-5	312-5	260	260	.540	.540	108°
HYDRAULIC	21-244-5	312H-10	312-5	312-5	260	260	.540	.540	110°
HYDRAULIC	21-320-4	320H-8	320-5	320-5	268	268	.540	.540	108°
SOLID	21-629-5	310A-8	310-1	310-1	275	275	.585	.585	108°
SOLID	21-631-5	320B-8	320-1	320-1	283	283	.588	.588	108°
ROLLER	23-730-9	324CR-8	324-8	324-8	286	286	.750	.750	108°
CHRYSLER V8 392 HEMI 1957-1958			CUSTOM GRINDS AVAILABLE (26-000-5 & 26-000-9)						
CHRYSLER V8 426 HEMI 1966-1971 w/ 1.57 INTAKE / 1.52 EXHAUST ROCKERS			CUSTOM GRINDS AVAILABLE						
HYDRAULIC	24-243-5	305H-10	305-3	305-3	253	253	.549	.532	110°
SOLID	24-312-5	310S-6	310-1	310-1	275	275	.612	.593	106°
ROLLER	24-731-9	324DR-6	324-8	324-8	286	286	.785	.760	106°
ROLLER	24-734-9	333AR-6	333-1	333-1	292	292	.785	.760	106°
ROLLER	24-722-9	320AR-8	320-30	320-30	284	284	.800	.775	108°
ROLLER	24-779-9	336BR-10	336-4	324-9	296	286	.747	.669	110°
ROLLER	24-740-9	336ER-12	336-5	332-2	296	292	.690	.669	112°
ROLLER	24-750-9	331FR-16	331R-2	331R-2	296	296	.788	.763	116°
ROLLER	24-758-9	326BR-15	326-30	326-30	293	293	.800	.775	115°
CHRYSLER V8 426 HEMI 1966-1971 (w/ 48° BANK ANGLE AND 2.124" JOURNALS)			CUSTOM GRINDS AVAILABLE						
ROLLER	24-742-10	332FR-12	332-6	332-6	292	292	.747	.693	112°
FORD L4 2000, 2300 OHC 1983-1987 (SEE FOOTNOTE #53)			CUSTOM GRINDS AVAILABLE						
SOLID	70-200-6	272S-12	272	272	236	236	.437	.437	112°
FORD 1600 L4 OHC 1965-1985			CUSTOM GRINDS AVAILABLE (71-000-5)						
FORD 2000 L4 OHC 1970-1977 (3 BEARING JOURNAL)			CUSTOM GRINDS AVAILABLE (72-000-5)						
FORD L6 240-300 1965-1995 W/ 1.6 ROCKERS			CUSTOM GRINDS AVAILABLE						
SOLID	66-243-5	264S-8	264	264	220	220	.469	.469	108°
SOLID	66-677-5	280B-6	280	284	242	246	.541	.522	106°
FORD V6 SVO ODD FIRE w/ 1.6 ROCKERS			CUSTOM GRINDS AVAILABLE						

APPLICATIONS/CAMSHAFTS	PART #	GRIND #	DURATION IN DEGREES				VALVE LIFT		LOBE SEPARATION ANGLE
			ADVERTISED		@ .050"		IN	EX.	
			IN	EX.	IN	EX.			
ROLLER	39-640-9	300AR-4	300-7	304-7	268	272	.650	.650	104°
ROLLER	39-650-9	304BR-6	304-7	308-7	272	276	.650	.650	106°
FORD V6 SVO EVEN FIRE w/ 1.6 ROCKERS						CUSTOM GRINDS AVAILABLE			
ROLLER	40-740-9	300CR-4	300-7	304-7	268	272	.650	.650	104°
ROLLER	40-750-9	304DR-6	304-7	308-7	272	276	.650	.650	106°
FORD V8 221-302 (INCLUDES 221, 260, 289 & 302) 1963-1995 w/ 1.6 ROCKERS						CUSTOM GRINDS AVAILABLE			
HYDRAULIC	31-214-4	244H-10	244-1	244-1	196	196	.410	.410	110°
HYDRAULIC	31-408-4	252AH-10	252-5	260-8	206	212	.433	.447	110°
HYDRAULIC	31-412-4	260AH-8	260-9	268-9	212	218	.474	.474	108°
HYDRAULIC	31-416-4	268AH-8	268-4	276-4	222	226	.494	.494	108°
HYDRAULIC	31-418-4	270AH-8	270-4	280-4	224	230	.501	.512	108°
HYDRAULIC	31-422-4	280AH-8	280-9	288-9	232	237	.515	.515	108°
HYDRAULIC	31-424-4	286AH-8	286-3	292-3	236	244	.523	.518	108°
HYDRAULIC	31-430-4	296AH-8	296-3	305-2	246	253	.544	.560	108°
HYDRAULIC	31-434-4	305AH-8	305-2	312-5	253	260	.560	.576	108°
HYDRAULIC	31-436-4	312AH-8	312-5	320-5	260	268	.576	.576	108°
SOLID	31-600-5	270S-8	270-1	270-1	235	235	.528	.528	108°
SOLID	31-644-5	310B-6	310-1	320-1	274	283	.624	.627	106°
SOLID	31-645-5	320B-8	320-1	324-1	283	286	.627	.616	108°
ROLLER	31-762-9	288AR-12	288-4	300-2	244	255	.586	.613	112°
ROLLER	31-766-9	288BR-6	288-5	296-5	252	260	.672	.672	106°
ROLLER	31-769-9	306BR-4	306-2	306-2	276	276	.667	.667	104°
ROLLER	31-770-9	306CR-8	306-1	319-1	273	283	.640	.640	108°
FORD V8 5.0 1985-1995 w/ 1.6 ROCKERS						CUSTOM GRINDS AVAILABLE			
HYDRAULIC ROLLER	35-300-8	270HR-12	270	276	215	220	.533	.544	112°
FORD V8 351W 1968-1995 w/ 1.6 ROCKERS						CUSTOM GRINDS AVAILABLE			
HYDRAULIC	35-408-4	252AH-10	252-5	260-8	206	212	.433	.447	110°
SOLID	35-333-4	270S-10	270-3	270-3	224	224	.499	.499	110°
SOLID	35-334-4	282S-10	282-2	282-2	236	236	.528	.528	110°
SOLID	35-336-4	306S-10	306-5	306-5	260	260	.592	.592	110°
SOLID	35-746-7	294Z-6	294N-1	304N-3E	262	266	.640	.624	106°
SOLID	35-750-7	306XZ-8	306XX	320-12	274	284	.652	.658	108°
ROLLER	35-805-9	300BR-6	300-5	304-5	264	268	.672	.672	106°
ROLLER	35-819-9	294CR-6	RT294-2	304-5	264	268	.688	.672	106°
ROLLER	35-821-9	298CR-6	RT298-2	308-5	268	272	.696	.672	106°
ROLLER	35-809-9	308BR-6	308-5	312-5	272	276	.672	.672	106°
ROLLER	35-811-9	312BR-6	312-5	316-5	276	280	.672	.672	106°
FORD V8 351W 1968-1995 REVERSE ROTATION						CUSTOM GRINDS AVAILABLE (35-000-5RR)			
FORD V8 351C, 351M 1970-1982 w/ 1.73 ROCKERS						CUSTOM GRINDS AVAILABLE			
HYDRAULIC	32-214-4	252BH-12	252-6	252-5	201	206	.467	.467	112°
HYDRAULIC	32-300-4	252AH-10	252-5	260-8	206	212	.465	.481	110°
HYDRAULIC	32-309-4	268AH-8	268-4	276-4	222	226	.531	.531	108°
HYDRAULIC	32-310-4	276AH-10	276-3	284-3	228	236	.544	.544	110°
HYDRAULIC	32-312-4	280AH-8	280-9	288-9	232	237	.554	.554	108°
HYDRAULIC	32-314-4	286AH-8	286-3	292-3	236	244	.562	.556	108°
HYDRAULIC	32-315-4	286AH-10	286-3	292-3	236	244	.562	.556	110°
HYDRAULIC	32-318-4	296AH-8	296-3	305-4	246	253	.585	.581	108°
HYDRAULIC	32-322-4	305AH-8	305-4	312-6	253	260	.581	.607	108°
HYDRAULIC	32-324-4	312AH-8	312-6	320-9	260	268	.607	.607	108°
SOLID	32-550-5	270S-8	270-1	270-1	237	237	.570	.570	108°
SOLID	32-643-5	295B-6	295-1	310-2	260	270	.645	.648	106°
SOLID	32-645-5	310B-6	310-2	314-1	270	276	.648	.641	106°
SOLID	32-646-5	320B-8	320-2	324-1	280	286	.648	.667	108°
ROLLER	32-684-9	292BR-4	292-6	296-4	262	266	.702	.702	104°

APPLICATIONS/CAMSHAFTS	PART #	GRIND #	DURATION IN DEGREES				VALVE LIFT		LOBE SEPARATION ANGLE
			ADVERTISED		@ .050"		IN	EX.	
			IN	EX.	IN	EX.			
ROLLER	32-688-9	296BR-4	296-4	300-7	266	270	.702	.702	104°
ROLLER	32-778-9	306CR-8	306-1	319-1	273	283	.692	.692	108°
FORD V8 332-406 1958-1962			CUSTOM GRINDS AVAILABLE (104-000-5)						
FORD V8 352-428 1958-1976 w/ 1.73 ROCKERS			CUSTOM GRINDS AVAILABLE						
HYDRAULIC	33-300-4	252AH-10	252-5	260-8	206	212	.476	.492	110°
HYDRAULIC	33-308-4	270AH-10	270-4	280-3	224	230	.551	.539	110°
HYDRAULIC	33-310-4	276AH-10	276-3	284-3	228	236	.556	.556	110°
HYDRAULIC	33-312-4	286AH-8	286-3	292-3	236	244	.575	.569	108°
HYDRAULIC	33-316-4	296AH-10	296-3	305-4	246	253	.598	.595	110°
HYDRAULIC	33-320-4	305AH-8	305-4	312-6	253	260	.595	.621	108°
HYDRAULIC	33-243-5	320H-10	320-9	320-9	268	268	.611	.611	110°
SOLID	33-640-5	279B-8	MA279-1	MA287-1	252	260	.588	.588	108°
SOLID	33-649-5	304B-8	304-1	314-1	266	276	.626	.653	108°
ROLLER	33-788-9	295DR-8	299	309	266	276	.686	.644	108°
ROLLER	33-789-9	308BR-8	312	326	276	286	.739	.751	108°
ROLLER	33-786-9	321BR-8	323	336	288	298	.774	.739	108°
FORD V8 429-460 1968-1999 w/ 1.73 ROCKERS			CUSTOM GRINDS AVAILABLE						
HYDRAULIC	34-228-4	252BH-10	252-5	260-8	206	212	.467	.484	110°
HYDRAULIC	34-240-4	260AH-10	260-8	268-5	212	218	.484	.496	110°
HYDRAULIC	34-244-4	268AH-10	268-4	276-4	222	226	.535	.535	110°
HYDRAULIC	34-246-4	276AH-10	276-3	284-3	228	236	.547	.547	110°
HYDRAULIC	34-248-4	286AH-8	286-3	292-3	236	244	.565	.560	108°
HYDRAULIC	34-253-4	292AH-10	292-3	296-3	244	246	.560	.588	110°
HYDRAULIC	34-256-4	305AH-8	305-4	312-6	253	260	.585	.610	108°
HYDRAULIC	34-338-5	312H	312-6	312-6	260	260	.610	.610	110°
HYDRAULIC	34-258-4	312AH-8	312-6	320-9	260	268	.610	.610	108°
HYDRAULIC	34-339-5	320H-10	320-9	320-9	268	268	.610	.610	110°
SOLID	34-655-5	324B-8	324-1	324-1	286	286	.667	.667	108°
SOLID	34-662-5	324C-10	324-1	334-2	286	296	.692	.692	110°
ROLLER	34-713-9	296BR-8	296-5	304-5	260	268	.726	.726	108°
ROLLER	34-740-9	313CR-10	313	319	281	286	.806	.763	110°
ROLLER	34-814-9	326QR-20	326-30	360-5	292	320	.882	.830	120°
ROLLER	34-810-9	324DR-14	324-30	352-1	288	312	.882	.825	114°
ROLLER	34-789-9	328QR-16	328-11	356-5	288	316	.836	.830	116°
HARLEY DAVIDSON SHOVELHEAD V-TWIN 1970-1977			CUSTOM GRINDS AVAILABLE						
HYDRAULIC ROLLER	78-4001	N/A	N/A	N/A	236	236	.450	.450	104°
HYDRAULIC ROLLER	78-4011	N/A	N/A	N/A	236	236	.485	.485	104°
HYDRAULIC ROLLER	78-4041	N/A	N/A	N/A	242	252	.485	.485	104°
HARLEY DAVIDSON SHOVELHEAD V-TWIN 1978-1984			CUSTOM GRINDS AVAILABLE						
HYDRAULIC ROLLER	78-4000	N/A	N/A	N/A	236	236	.450	.450	104°
HYDRAULIC ROLLER	78-4010	N/A	N/A	N/A	236	236	.485	.485	104°
HYDRAULIC ROLLER	78-4040	N/A	N/A	N/A	242	252	.485	.485	104°
HOLDEN 6 CYL. 173-202 1963-1986			CUSTOM GRINDS AVAILABLE (81-000-5)						
HOLDEN V8 252-308 1970-1988 w/ 1.5 ROCKERS			CUSTOM GRINDS AVAILABLE						
HYDRAULIC	82-205-4	252H	252-5	252-5	206	206	.433	.433	110°
HYDRAULIC	82-206-4	260H	260-8	260-8	212	212	.447	.447	110°
HYDRAULIC	82-210-4	268H	268-5	268-5	218	218	.456	.456	110°
HYDRAULIC	82-212-4	280H	280-3	280-3	230	230	.490	.490	110°
HYDRAULIC	82-213-4	292H	292-3	292-3	244	244	.518	.518	110°
HYDRAULIC	82-242-4	XE268H	268	280	224	230	.509	.512	110°
MITSUBISHI L4 2000, 2600 1979-1987			CUSTOM GRINDS AVAILABLE (95-000-5)						
NISSAN 1595-1952CC L16, 18, 20B 4 CYL. 1960-1980			CUSTOM GRINDS AVAILABLE						
SOLID	79-119-6	252S-10	252	252	204	204	.440	.440	110°
SOLID	79-123-6	260S-10	260	260	214	214	.459	.459	110°

APPLICATIONS/CAMSHAFTS	PART #	GRIND #	DURATION IN DEGREES				VALVE LIFT		LOBE SEPARATION ANGLE
			ADVERTISED		@ .050"		IN	EX.	
			IN	EX.	IN	EX.			
SOLID	79-127-6	268S-10	268	268	222	222	.461	.461	110°
SOLID	79-131-6	280S-10	280	280	236	236	.495	.495	110°
SOLID	79-135-6	292S-10	292	292	246	246	.516	.516	110°
NISSAN/DATSUN 6 CYL. SOHC			CUSTOM GRINDS AVAILABLE (80-000-5)						
OLDSMOBILE V8 260-455 1965-1990 w/ 1.6 ROCKERS			CUSTOM GRINDS AVAILABLE						
HYDRAULIC	42-306-4	268AH-10	268-4	276-4	222	226	.494	.494	110°
HYDRAULIC	42-310-4	276AH-10	276-3	284-3	228	236	.506	.506	110°
HYDRAULIC	42-313-4	280AH-10	280-9	288-9	232	237	.515	.515	110°
HYDRAULIC	42-317-4	286AH-10	286-3	292-3	236	244	.523	.518	110°
HYDRAULIC	42-321-4	292AH-10	292-3	296-3	244	246	.518	.544	110°
HYDRAULIC	42-238-5	312H-10	312-6	312-6	260	260	.565	.565	110°
HYDRAULIC	42-239-5	320H-10	320-9	320-9	268	268	.565	.565	110°
SOLID	42-656-5	300B-6	300-1	314-1	265	276	.600	.594	106°
OLDSMOBILE V8 260-455 45° BANK ANGLE			CUSTOM GRINDS AVAILABLE (103-000-5)						
PONTIAC V8 265-455 1958-1981 w/ 1.5 ROCKERS			CUSTOM GRINDS AVAILABLE						
HYDRAULIC	51-228-4	244H-10	244-2	244-2	196	196	.400	.400	110°
HYDRAULIC	51-300-4	252AH-10	252-4	260-7	206	212	.424	.440	110°
HYDRAULIC	51-304-4	260AH-10	260-9	268-9	212	218	.444	.444	110°
HYDRAULIC	51-308-4	268AH-8	268-4	276-4	222	226	.463	.463	108°
HYDRAULIC	51-312-4	286AH-8	286-3	292-2	236	244	.489	.500	108°
HYDRAULIC	51-318-4	286AH-10	286-3	292-2	236	244	.489	.500	110°
HYDRAULIC	51-330-4	305AH-8	305-2	312-5	253	260	.525	.540	108°
SOLID	51-506-5	296TL-6	TL296-1	310-1	266	275	.570	.585	106°
SOLID	51-661-5	310B-8	310-1	314-1	275	276	.585	.556	108°
ROLLER	51-813-9	285CR-6	285-2	295-2	252	262	.619	.604	106°
ROLLER	51-816-9	306CR-8	306-1	319-1	270	280	.660	.660	108°
ROLLER	51-822-9	306CR-4	306-2	309-2	275	278	.688	.693	104°
ROLLER	51-823-9	316DR-6	316-2	316-2	284	284	.715	.715	106°
ROLLER	51-825-9	312R-4	312-8	312-8	284	284	.728	.728	104°
TOYOTA 2TC-3TC OHV 1588CC, 1770CC 1971-1982			CUSTOM GRINDS AVAILABLE (74-000-5)						
VOLKSWAGEN 1200-1600CC TYPE 1 4 CYL. 1955-1971			CUSTOM GRINDS AVAILABLE						
SOLID	73-115-4	244S	244	244	200	200	.293	.293	108°
SOLID	73-119-4	252S	252	252	210	210	.319	.319	108°
SOLID	73-123-4	264S	264	264	220	220	.323	.323	108°
SOLID	73-128-4	270S	270	270	235	235	.364	.364	108°
SOLID	73-130-4	280S	280	280	242	242	.372	.372	108°
VOLKSWAGEN 1457-1788CC SOHC 4 CYL. 1974-1989			CUSTOM GRINDS AVAILABLE						
SOLID	85-119-4	252S	252	252	204	204	.410	.410	110°
SOLID	85-123-4	260S	260	260	214	214	.410	.410	110°

SEE OUR MASTER LOBE PROFILE CATALOG FOR A COMPLETE LIST OF ALL OF THE CAM CORES AND LOBES THAT COMP CAMS® HAS TO OFFER.

Part #LC2013

COMP CAMS® SPECIAL SERVICES

A partial listing of the most common high end treatments and special processes you can order for your COMP Cams® camshaft. Additional services are available; contact us for any special needs.

CAMSHAFT SURFACE PREPARATIONS

Nitriding – Part #1-111-1

This is the most effective process for extending the life of a high performance flat tappet camshaft. Nitriding increases the hardness of the camshaft surface metal by physically injecting nitrogen "needles" into the surface of the lobes and journals to increase their resistance to wear.

Camshaft Micropolishing – Part #1-114-1

This procedure removes microscopic imperfections in the surface of the metal. Micropolishing can further increase the durability of the camshaft and can be performed to only the camshaft lobes or all wear surfaces.

Xtreme Surface Finish Enhancement – Part #1-137-1

Our highest-quality finishing process involving considerably more polishing than any other procedure. This is most commonly used in steel-on-steel contact valve train situations, such as high end circle track flat tappet camshafts where billet materials have repeated contact in extremely high RPM environments.

PRECISION CAMSHAFT MEASUREMENT

Basic Camshaft Profiling – Part #1-126-1

Performed on two lobes of any camshaft, the component is measured to determine its lift, duration and lobe centerline specifications.

Adcole Camshaft Profiling – Part #1-125-1

Our highest precision camshaft measuring device, the Adcole, checks all 16 camshaft lobes to determine that the cam meets all specifications requested by the customer. The Adcole measures camshaft specifications to 0.00001 of an inch.

SPECIAL OPERATIONS

Replacement of the Camshaft Dowel Pin – Part #1-120-1

This is a process which repairs camshafts when the current dowel pin has either been sheared off or damaged in some manner. The old dowel pin (or remaining part) is removed by machining and a new dowel pin is inserted.

Installation of Dual Dowel Pins – Part #1-121-1

For certain applications, dual dowel pins can be installed to further ensure that the camshaft and timing gear connection are secure. This is most commonly done with early model Ford V8s and classic Chrysler Hemi engines. The timing gear can also be machined to adapt to this new configuration.

Drilling and Tapping Camshaft Nose – Part #1-136-1

A process performed on Viper camshafts, the nose of the camshaft is drilled and then tapped to convert from a single timing gear bolt-up to a three-bolt aftermarket timing chain set. This allows for a wider selection of timing sets.

Machining a Rear Camshaft Journal Groove – Part #1-119-1

A process commonly performed on 1965-66 Big Block 396c.i. Chevrolet engines, which features oiling systems that require a groove be cut into the rear journal of the camshaft. This was a two-year only condition, not required in all 1967 and newer Big Block Chevrolet engines.

Machining of the Rear Pump Drive – Part #1-116-1

Allows sprint car-style engines to run the fuel pump from the rear of the camshaft rather than traditional placements.

Side Cutting of Camshaft Lobes – Part #1-127-1

A process often requested that helps to keep the lifters from making contact with adjacent lobes when the engine's lifter bores have been enlarged.

Sleeving of the Camshaft Journal – Part #1-132-1

Most popular with Ford Windsor engine roller bearing camshaft applications, a sleeve is placed around the standard rear journal to increase the size of the journal, making it compatible with rear roller bearing usage.

Fuel Pump Lobe Regrinding – Part #9-999-1

A refinishing process used to clean up a fuel pump lobe which may have been damaged or is showing excessive wear.



SCAN THE QR CODE

to fill out our online cam recommendation form and receive a camshaft selected specifically for your engine.



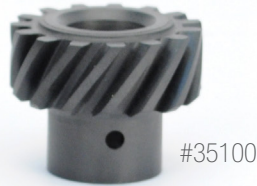

COMPOSITE DISTRIBUTOR GEARS

Manufactured from carbon ultra-poly, these represent the future of distributor gears. They are available for Small & Big Block Chevrolets with .500" or .491" distributor shafts, Small Block Ford and Chrysler R5 applications. These gears have undergone stringent testing in various applications with positive results and show great promise in solving the wear issues associated with bronze gears in racing applications with 300% increased durability. *Composite gears are not recommended for use with high volume or high pressure oil pumps.

BRONZE DISTRIBUTOR GEARS

One of the first requirements when installing a steel roller cam is the addition of a bronze distributor gear. A stock cast iron gear is not compatible with a steel camshaft. COMP Cams® gears are machined from AMPCO-45 extruded aluminum bronze with 5% nickel added. These gears feature a high-strength tooth design that resists wear even when used with high-pressure oil pumps. These extra tough gears are the answer when higher mechanical properties are demanded.

MELONIZED DISTRIBUTOR GEARS

For your hydraulic or solid roller iron gear camshafts, it is recommended that you use a melonized distributor gear. These gears have undergone a "salt bath" nitriding process that gives them an extremely hard and slick surface to prevent excessive friction and wear, as well as rust accumulation. Used for factory engines, melonized steel distributor gears are harder than the standard iron or bronze gears.

OLDSMOBILE CAST IRON DISTRIBUTOR GEAR

Made for use with flat tappet cams, cast iron distributor gears are developed in a manner which solidifies the outer layer, while leaving the core molten iron. Since cast iron contains 2% carbon, these gears work well with cam gears made from the same material. The COMP Cams® Oldsmobile Cast Iron Distributor Gear is also nitrided for wear protection and longevity.



MAKE	DESCRIPTION	FITS SHAFT DIAMETER	PART #
Oldsmobile	Oldsmobile Cast Iron Distributor Gear	.491"	20442

MAKE	DESCRIPTION	FITS SHAFT DIAMETER	PART #
COMPOSITE DISTRIBUTOR GEARS			
Chevrolet	V8 Small & Big Block	.491"	12200
	V8 Small & Big Block	.500"	12140
	.006" Oversized	.500"	12146
	.009" Oversized	.500"	12149
Chrysler	R5	.500"	55200
Ford	302-351W	.500"	35100
	302-351W	.530"	35200
BRONZE DISTRIBUTOR GEARS			
Chevrolet	4 Cyl. 153	.491"	461
	6 Cyl. 194-250, 292	.491"	461
	90° V6 200-262	.491"	412
	90° V6 200-262 w/ MSD Distributor	.500"	410
	90° V6 200-262 w/ ACCEL Distributor	.500"	411
	V8 265-400	.491"	412
	V8 265-400 w/ MSD Distributor	.500"	410
	V8 265-400 w/ ACCEL Distributor	.500"	411
	V8 265-400 (Reverse Rotation)	.491"	413
	V8 396-454	.491"	412
	V8 396-454 w/ MSD Distributor	.500"	410
	V8 396-454 w/ ACCEL Distributor	.500"	411
	V8 396-454 (Reverse Rotation)	.491"	413
	Chrysler	V8 273-360 "LA", Donovan V8	.484"
V8 "B" 383-400		.484"	424
V8 426 Hemi		.484"	424
Ford	6 Cyl. 240-300	.530"	466
	V8 260-302, Boss 302-351W	.467"	431
	V8 260-302, Boss 302-351W	.500"	438
	SV0 V8 302-351W	.530"	435
	V8 351C 351-400M	.530"	436
	V8 351C, Boss 351, 351-400M	.500"	432
	V8 352-428	.467"	433
	V8 352-428	.500"	432
	V8 429, 460	.500"	432
V8 429, 460	.530"	436	
Oldsmobile	V8 260-455	.491"	442
Pontiac	4 Cyl. 151 (1977-78)	.491"	461
	4 Cyl. 151 (1979-89) Oil Pump Gear	.491"	461
	V8 265-455	.491"	451
MELONIZED STEEL DISTRIBUTOR GEARS			
Chevrolet	V8 Small & Big Block	.491"	412M
	V8 Small & Big Block	.500"	410M
Ford	V8 302-351W	.467"	431M
	V8 302-351W	.531"	435M



SCAN THE QR CODE

to watch a video on proper distributor gear selection.





#1591



#1590



#159

ENGINE BREAK-IN LUBRICANTS

Due to government regulations, in recent years oil manufacturers have removed the Zinc and many other additives from their motor oils. Using one of these “off-the-shelf” brands of oil during the critical break-in process can lead to a failure. Thus, COMP Cams® Engine Break-In Oil and Additive are designed to extend the durability of internal engine components including camshafts, valve train components and all moving parts in your new or rebuilt engine. They do so by using a special blend of extreme pressure additives no longer available in “off-the-shelf” motor oils. COMP Cams® Engine Break-In Oil provides added protection during the break-in process and is compatible with any petroleum, synthetic or blended motor oil.

- Improve surface mating of rotating assembly, rod journals, piston rings, valve guides, cam & lifters, etc.
- Protect all internal engine components, including both flat tappet & roller valve trains
- Proprietary additive package includes optimum amounts of ZDDP (Zinc & Phosphorus), Molybdenum & detergents
- Require no additives or supplements for maximum protection
- Compatible with gasoline, methanol & high octane race fuels

DESCRIPTION	SIZE	PART #
10W30 Engine Break-In Oil	1 Qt.	1590
10W30 Engine Break-In Oil	(12) 1 Qt. Bottles	1590-12
10W30 Engine Break-In Oil	(56 Case) Pallet	1590-PLT
15W50 Engine Break-In Oil	1 Qt.	1591
15W50 Engine Break-In Oil	(12) 1 Qt. Bottles	1591-12
15W50 Engine Break-In Oil	(56 Case) Pallet	1591-PLT
Engine Break-In Oil Additive	12 oz. Bottle	159
Engine Break-In Oil Additive	(12) 12 oz. Bottles	159-12
Engine Break-In Oil Additive	5 Gallon Bucket	260

Note: MSDS available on request.



SCAN THE QR CODE

to watch a video on the proper flat tappet camshaft break-in procedure.



SCAN THE QR CODE

to read the COMP Cams® Flat Tappet Tech Bulletin and learn ways to save your engine.





MUSCLE CAR & STREET ROD ENGINE OIL

The COMP Cams® Muscle Car & Street Rod Engine Oil is a blended-synthetic oil that delivers the time-tested wear protection of a mineral oil with the advanced performance, extended change intervals and internal cleanliness of a synthetic. Special corrosive protection additives and optimum amounts of ZDDP (Zinc and Phosphorus) provide unmatched anti-wear properties, even during extended periods of storage. This advanced engine oil is available in both 10W30 and 15W50 formulas and is perfect for late model or classic engines with flat tappet valve trains. After incorporating three decades of internal engine know-how and extensive testing data, we're certain that there's nothing better for your muscle car or street rod.

- Protects against internal engine corrosion, oxidation and rust; requires no extra additives
- Blended-synthetic lubricant includes Zinc, Phosphorus and Molybdenum for the ultimate in wear protection
- Unrivalled start-up protection for both classic flat tappet and late model roller valve trains
- 10W30 and 15W50 weights specially formulated for muscle car and street rod applications

DESCRIPTION	SIZE	PART #
10W30 Muscle Car & Street Rod Engine Oil	1 Qt.	1594
10W30 Muscle Car & Street Rod Engine Oil	(12) 1 Qt. Bottles	1594-12
10W30 Muscle Car & Street Rod Engine Oil	(56) Case Pallet	1594-PLT
15W50 Muscle Car & Street Rod Engine Oil	1 Qt.	1595
15W50 Muscle Car & Street Rod Engine Oil	(12) 1 Qt. Bottles	1595-12
15W50 Muscle Car & Street Rod Engine Oil	(56) Case Pallet	1595-PLT

Note: MSDS available on request.

SPECIALTY LUBRICANTS

COMP Cams® has taken great pains to develop what we feel to be the best line of lubricants on the market to protect your valve train and engine. These will protect your internal engine components before start-up, during break-in and throughout the life cycle of your engine.

- Three different formulas protect internal engine components
- Protected valve train parts include: camshaft, lifters, valve springs, rocker arms, pushrods and distributor gear
- Contain high viscosity, extreme pressure additives not found in today's conventional oils and lubricants
- Compatible with all petroleum, synthetic and blended engine oils

DESCRIPTION	SIZE	PART #
Valve Train Assembly Spray	6 oz. Aerosol Can	106
Cam & Lifter Installation Lube	5/8 fl. oz.	103
Cam & Lifter Installation Lube	4 oz. Bottle	152
Cam & Lifter Installation Lube	8 oz. Bottle	153
Cam & Lifter Installation Lube 6-Pack	(6) 4 oz. Bottles	198
Engine Assembly Lube	4 oz. Jar	102
Engine Assembly Lube	8 oz. Jar	104
Engine Assembly Lube	14 oz. Tube	127

Note: MSDS available on request.



FLAT TAPPET VS. ROLLER TAPPET LIFTERS

In nearly all circumstances, a good roller camshaft design will outperform its flat tappet counterpart. Among the benefits of roller cams are higher tappet velocity, more lift and more area, along with reduced valve train friction (often a 20+ HP increase) and higher engine RPM with little effect on low speed drivability and power.

Roller tappets are also reusable, which makes it possible to swap just the camshaft without the expense of new lifters. And finally, roller tappets are far less prone to wear – allowing higher spring loads – and they are more consistent with today's oils.

The biggest advantage with a flat tappet cam and lifters is the up front cost. It can be significantly less expensive to use a flat tappet setup but should you decide to install a new camshaft, you will need new lifters as well.

HYDRAULIC VS. MECHANICAL (SOLID) LIFTERS

Both lifter types look the same from the outside, with both having pushrod seats held in by a retaining clip. In a hydraulic lifter the seat moves by means of a hydraulic valve and oil pressure within the lifter. The mechanical lifter does not have a valve and is solid.

The pushrod seat in a solid lifter sits upon an internal step inside the lifter body, preventing it from moving. The hydraulic lifter, on the other hand, has a pushrod seat that sits on top of a moveable hydraulic mechanism which acts like a tiny hydraulic pump. Below this mechanism are a valve and spring that produce an upward force, moving the seat up against the pushrod when the lifter is on the base circle.

Solid cam designs require a running clearance or "valve lash." Hydraulic cams are the exact opposite. In a standard hydraulic lifter the pushrod takes up all of the clearance and submerges into the lifter's pushrod seat approximately .020"-.070". The distance that the pushrod submerges is known as the "pre-load."

SHORT TRAVEL HYDRAULIC ROLLER LIFTERS

COMP Cams® Short Travel Hydraulic Roller Lifters are the perfect choice for use in mandated hydraulic roller racing classes and high performance/race applications. The limited plunger travel extends the usable RPM range by up to 500+ RPM, but still remains a hydraulic lifter while staying as close to a mechanical lifter as possible. See page 243 for more information.



SETTING VALVE LASH WITH A SOLID LIFTER CAMSHAFT

First, check the spec card that came with your cam for the correct valve lash specifications. All COMP Cams® valve lash settings are “hot” settings (set at normal engine operating temperature) but will work for initial start-up as well.

Turn the crankshaft in the direction of normal engine rotation until the exhaust pushrod of the cylinder you are adjusting begins to move upward, opening the valve. Adjust the INTAKE lash by tightening the intake rocker nut with the correct thickness feeler gauge inserted between the valve stem and the rocker tip. Tighten the rocker nut until there is a slight drag when moving the feeler gauge. Next, rotate the engine until the intake pushrod fully opens the valve and then goes halfway back down. Adjust the EXHAUST rocker nut (with correct feeler gauge) using the same procedure previously described. Repeat for all remaining cylinders.

After setting your valve lash with the engine cold, start it and follow the appropriate break-in procedures. Your valve lash setting will change as the engine heats dependent upon the material of your cylinder heads and block. You will need to repeat the process to ensure your valve lash matches that specified by your cam card at normal operating temperatures.

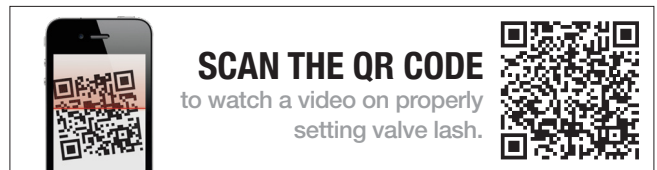

SETTING HYDRAULIC LIFTER PRE-LOAD (ADJUSTABLE VALVE TRAIN)

When installing a hydraulic camshaft, lifters or rocker arms, establishing the correct lifter pre-load improves both performance and engine life. Insufficient pre-load will create excessive valve train noise and wear. Excessive pre-load will cause rough idling and low manifold vacuum and, can even lead to severe engine damage. With an adjustable valve train, proceed as follows:

Install the pushrods and rocker arms. Be sure the pushrods are seated correctly in the lifter and rocker arm. Turn the engine over in the direction of rotation until the EXHAUST pushrod just begins to move upward, opening the valve. Now adjust the INTAKE rocker of that cylinder. Carefully tighten the nut on the intake rocker while spinning the pushrod with your fingertips. You will feel a slight resistance in the pushrod when you have taken up all of the clearance. This is “zero lash.” Turn the adjusting nut to the specified pre-load – typically 1/4-3/4 of a turn, but this will vary based on the lifter model. Comp Cams® Short Travel Lifters requires 0-1/4 of a turn.

Turn the engine in its rotation direction until the INTAKE pushrod comes all the way up and almost all the way back down. Now set the EXHAUST rocker to “zero lash” and add the specified pre-load. Repeat this process for all remaining cylinders.

SETTING HYDRAULIC LIFTER PRE-LOAD (NON-ADJUSTABLE VALVE TRAIN)

COMP Cams® recommends using an adjustable/checking pushrod to check the pre-load. Typically, only one cylinder needs to be checked in this process. After applying lube, install the adjustable pushrods and assemble the valve train. Using the same procedure mentioned earlier, adjust the intake and exhaust valves to zero lash by changing the length of the adjustable pushrod for precise fitment. Order a pushrod that is .020”-.070” longer than the pushrod length at zero lash to ensure the proper pre-load. Adjustable/checking pushrods are located on page 255 of this catalog.

HIGH ENERGY™ HYDRAULIC LIFTERS

- Patented orifice metering valve precisely meters oil to the rocker arms
- Continuous contact between the metering valve and pushrod seat is maintained, eliminating excessive oiling at high engine speeds
- Pushrod seat is made of a special powdered metal iron alloy that is heat-treated for strength and wear resistance
- Contain a longer piston than conventional hydraulic lifters, which provides more load bearing surface and increases lifter longevity
- Lightweight check valve disc allows for quicker response, which results in increased engine speed before valve float
- Lightweight check valve disc maintains added control at all engine speeds and loads

MAKE	DESCRIPTION	DIAMETER	WEIGHT	SEAT HEIGHT	PART #
AMC	V8 290-401	.904"	109g	1.88"	822-16
	6 Cyl. 199-258	.904"	109g	1.88"	822-12
Buick	V8 350-455	.842"	98g	2.05"	869-16
	181-252 1962-Present	.842"	98g	2.05"	869-12
Cadillac	V8 472-500	.842"	98g	2.05"	869-16
Chevrolet	V8 265-400	.842"	94g	1.99"	812-16
	V8 396-454	.842"	94g	1.99"	812-16
	V8 348-409, 1958-65	.842"	94g	1.99"	812-16
	6 Cyl. 194-292	.842"	94g	1.99"	812-12
	V6 60° 173, 207, 2.8L-3.4L	.842"	96g	2.05"	802-12
	V6 90° 200-262	.842"	94g	1.99"	812-12
Chrysler	V8 273-360	.904"	109g	1.88"	822-16
	V8 B-383-440, 1958-67	.904"	110g	1.91"	824-16
	V8 B-383-440, 1968-Present	.904"	109g	1.88"	822-16
	Hemi 426	.904"	110g	1.91"	824-16
	6 Cyl. 170-225, 1980-Present	.904"	102g	1.88"	820-12
	2.2L 4 Cyl.	.626"	46g	2.05"	842-8
Ford	V8 289-302-351W	.875"	105g	2.02"	832-16
	V8 351C-351M-400M	.875"	105g	2.02"	832-16
	V8 352-428	.875"	97g	1.88"	834-16
	V8 429-460	.875"	105g	2.02"	832-16
	6 Cyl. 240-300	.875"	105g	2.02"	832-12
	6 Cyl. 144-250	.875"	97g	1.88"	834-12
	V6 231	.875"	105g	2.02"	832-12
	2600-2800cc V6 (158-171c.i.)	.875"	97g	1.88"	834-12
	2300cc 4 Cyl.	.842"	118g	2.49"	846-8
Int. Harvester	V8 266-392	.997"	138g	1.91"	855-16
Oldsmobile	V8 260-455	.842"	97g	2.05"	852-16
Pontiac	151 4 Cyl.	.842"	98g	2.05"	864-8
	V8 265-455	.842"	97g	2.05"	852-16

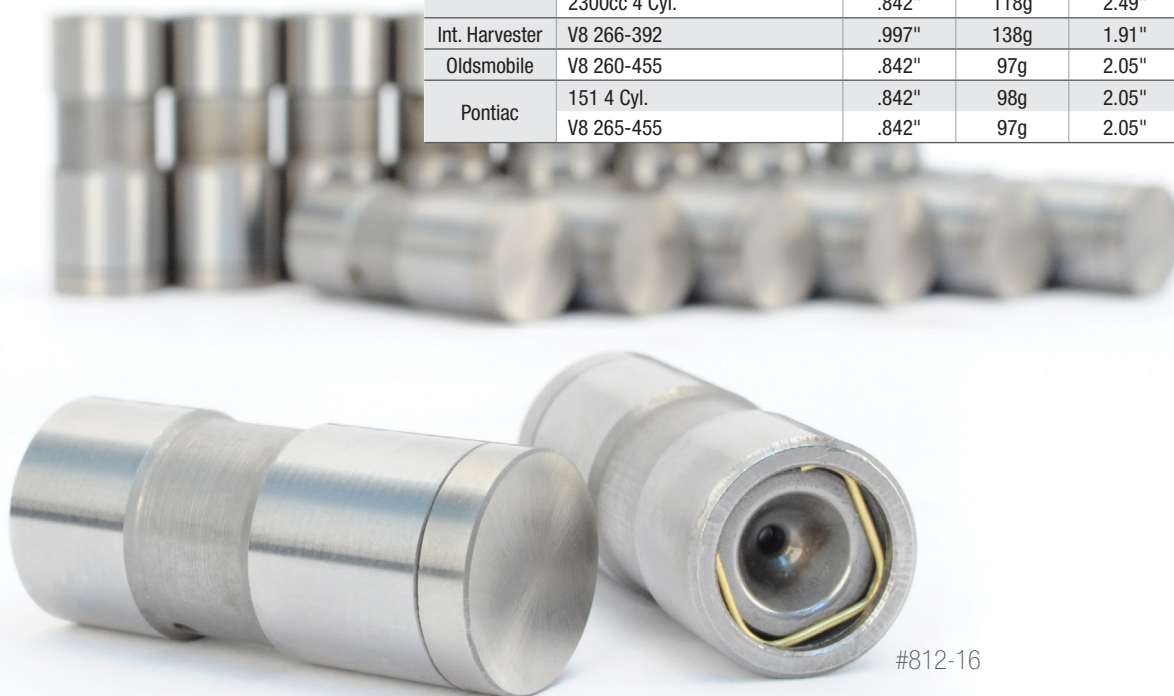

#812-16

PUSHROD MEASUREMENTS

Pushrod seat heights, diameters & weights are approximate (nominal). All weights are for individual lifters, excluding link bars, unless otherwise noted. All seat heights were determined with a 5/16" gauge ball in place. Illustration on page 243.

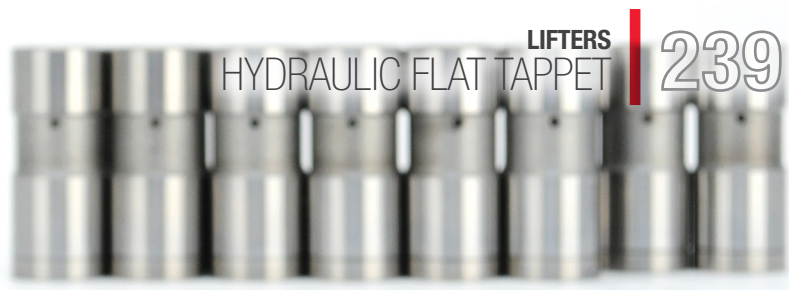

#858-16

PRO MAGNUM™ HYDRAULIC LIFTERS

- Specifically designed to perform at higher engine speeds
- Proper position of internal piston at higher RPM prevents lifters from harmful “pumping up”
- Unique design yields significant power increase over standard hydraulic lifters
- Adjustable valve train required
- Pre-load .002”-.004” with engine warm

MAKE	DESCRIPTION	DIAMETER	WEIGHT	SEAT HEIGHT	PART #
AMC	V8 290-401	.904"	107g	1.84"	867-16
	6 Cyl. 199-258	.904"	107g	1.84"	867-12
Buick	V8 350-455	.842"	94g	2.01"	865-16
	V6 183-252, 1962-Present	.842"	94g	2.01"	865-12
Chevrolet	V8 265-400	.842"	99g	1.93"	858-16
	V8 396-454	.842"	99g	1.93"	858-16
	V8 348-409, 1958-65	.842"	99g	1.93"	858-16
	6 Cyl. 194-292	.842"	99g	1.93"	858-12
	V6 90° 200-262	.842"	99g	1.93"	858-12
Chrysler	V8 273-360	.904"	107g	1.84"	867-16
	V8 B-383-440 1968-Present	.904"	107g	1.84"	867-16
Ford	V8 289-302-351W	.875"	105g	1.95"	862-16
	V8 351C-351M-400M	.875"	105g	1.95"	862-16
	V8 429-460	.875"	105g	1.95"	862-16
	V6 231	.875"	105g	1.95"	862-12
	6 Cyl. 240-300	.875"	105g	1.95"	862-12
Oldsmobile	V8 260-455	.842"	96g	2.01"	863-16
Pontiac	V8 326-455	.842"	96g	2.01"	863-16



#884

HI-TECH™ HYDRAULIC LIFTERS

- Greater bleed rate increases vacuum
- Increased throttle response for extremely hot street and racing applications
- Not recommended for extended periods of street use
- Set pre-load between .030”-.060”

MAKE	DESCRIPTION	DIAMETER	WEIGHT	SEAT HEIGHT	PART #
AMC	V8 290-401	.904"	109g	1.91"	882-16
Chevrolet	V8 265-400, 396-454, 348-409	.842"	95g	1.99"	880-16
Chrysler	V8 273-360, 383-440	.904"	109g	1.19"	882-16
Ford	V8 289-302, 351W, 429-460, 351C-400M	.875"	106g	2.09"	884-16
Oldsmobile	V8 260-455	.842"	95g	2.02"	886-16
Pontiac	V8 326-455	.842"	95g	2.02"	886-16

Note: For V6, use -12 suffix

RACE HYDRAULIC LIFTERS

- Tighter plunger-to-body tolerances and premium one-piece pushrod seats
- Super strict tolerances for the mechanical internals optimize performance
- Extra heavy-duty snap ring design increases lifter strength and durability
- Pre-load can be set between .000”-.030”



#84000

MAKE	DESCRIPTION	DIAMETER	WEIGHT	SEAT HEIGHT	PART #
Chevrolet	Small & Big Block Race Lifters	.842"	104g	2.01"	84000-16
Ford	Small & Big Block Race Lifters	.875"	122g	2.01"	84035-16



#813

SOLID/MECHANICAL LIFTERS

- Designed and manufactured using the tightest tolerances in the industry for ultra-precise construction
- Face of the lifter is ground to precise radius for proper break-in and guaranteed longer life
- Oil metering band is milled to exact depth to prevent too much oil from being delivered to the top of the engine

MAKE	DESCRIPTION	DIAMETER	WEIGHT	SEAT HEIGHT	PART #
AMC	V8 290-401	.904"	101g	1.79"	801-16
	V8 472-500	.842"	98g	1.88"	813-16
Cadillac	V8 265-400	.842"	98g	1.88"	813-16
Chevrolet	V8 265-400 w/ .875" Dia.	.875"	109g	1.95"	833-16
	V8 396-454	.842"	98g	1.88"	813-16
	V8 348-409 1958-65	.842"	98g	1.88"	813-16
	V6 90° 200-262	.842"	98g	1.88"	813-12
	6 Cyl. 194-292	.842"	98g	1.88"	813-12
Chrysler	V8 273-360	.904"	95g	1.63"	821-16
	6 Cyl. 170-255	.904"	95g	1.63"	821-12
	V8 273-360 (Oils Pushrod)	.904"	101g	1.79"	801-16
	V8 B-383-440 1958-Present	.904"	95g	1.63"	821-16
Ford	V8 Hemi 426	.904"	95g	1.63"	821-16
	V8 221-351W 1963-69	.875"	108g	1.95"	831-16
	V8 302-351W 1969-Present	.875"	109g	1.95"	833-16
	V8 Boss 302, 351C, 351M, 400M	.875"	109g	1.95"	833-16
	V8 352-428	.875"	102g	1.79"	835-16
	V8 352-428 (Shell Type)	.875"	61g	.46"	837-16
	V8 429-460	.875"	109g	1.95"	833-16
	6 Cyl. 240-300	.875"	108g	1.95"	831-12
	8 Cyl. 292, 312 Y-Block	.498"	70g	2.6"	2931-16
	8 Cyl. 239, 255 Flathead	1.000"	102g	Adj.	811FH-16
Oldsmobile	6 Cyl. 144-250,V6 2600-2800cc	.875"	102g	1.79"	835-12
	V8 260-455	.842"	97g	2.05"	852-16

TOOL STEEL SOLID/MECHANICAL LIFTERS

- Extremely tough and strong, yet lighter in weight than standard steel lifters
- DLC coating gives lifters slick and hard surface properties
- Wear resistance requires less power to run valve train and lowers friction, heat and oil temps
- Three diameters available in DLC coated, non-coated and non-coated EDM versions



#89842

#89842C

#89842H

EDM OILING HOLE

MAKE	DESCRIPTION	DIAMETER	WEIGHT	SEAT HEIGHT	OIL BAND HEIGHT	OIL BAND WIDTH	PART #
Chevrolet	Non-Coated for Use on Cast Cams w/ or w/o Nitriding, .012" Oil Hole	.842"	76g	1.88"	.90"	.50"	89842H-16
	Non-Coated for Use on Cast Cams w/ or w/o Nitriding	.842"	76g	1.88"	.90"	.50"	89842-16
	Coated for Use on Cams Using Steel Cores	.842"	76g	1.88"	.90"	.50"	89842C-16
Chrysler	Non-Coated for Use on Cams w/ or w/o Nitriding, .012" Oil Hole	.904"	84g	1.88"	.85"	.58"	89904H-16
	Non-Coated for Use on Cast Cams w/ or w/o Nitriding	.904"	84g	1.88"	.85"	.58"	89904-16
	Coated for Use on Cams Using Steel Cores	.904"	84g	1.88"	.85"	.58"	89904C-16
Ford	Non-Coated for Use on Cams w/ or w/o Nitriding, .012" Oil Hole	.875"	76g	1.95"	1.02"	.50"	89875H-16
	Non-Coated for Use on Cast Cams w/ or w/o Nitriding	.875"	76g	1.95"	1.02"	.50"	89875-16
	Coated for Use on Cams Using Steel Cores	.875"	76g	1.95"	1.02"	.50"	89875C-16

PERFORMANCE SERIES™ SOLID/MECHANICAL LIFTERS

Built to extreme precision tolerances to create the most durable solid lifters available, the COMP Cams® Performance Series™ Lifters are a premium lifter designed specifically for high-end street and race applications.

- Precision-ground crown radius and surface finish promote performance camshaft compatibility and high RPM durability
- Lightweight design and one-piece pushrod seat provide extended RPM range
- Feature a precision-machined and accurately located oil band to yield a consistent and properly metered oil flow
- Designed for elevated, race application valve spring pressures
- Ideal for high-end street and race engines



MAKE	DESCRIPTION	DIAMETER	WEIGHT	SEAT HEIGHT	OIL BAND HEIGHT	OIL BAND WIDTH	PART #
Cadillac	V8 472-500	.842"	86g	1.88"	1.10"	.41"	2900-16
Chevrolet	V8 265-400	.842"	86g	1.88"	1.10"	.41"	2900-16
	V8 396-454	.842"	86g	1.88"	1.10"	.41"	2900-16
	V8 348-409 1958-65	.842"	86g	1.88"	1.10"	.41"	2900-16
	V6 90° 200-262	.842"	86g	1.88"	1.10"	.41"	2900-12
	6 Cyl. 194-292	.842"	86g	1.88"	1.10"	.41"	2900-12
Chrysler	V8 273-360	.904"	95g	1.61"	–	–	2921-16
	V8 B-383-440 1958-Present	.904"	95g	1.61"	–	–	2921-16
	V8 Hemi 426	.904"	95g	1.61"	–	–	2921-16
Ford	V8 FS, FC, FF	.875"	98g	1.95"	1.00"	.54"	2910-16
Pontiac	V8 260-455	.842"	86g	1.88"	1.10"	.41"	2900-16
Oldsmobile	V8 265-455	.842"	86g	1.88"	1.10"	.41"	2900-16

PERFORMANCE SERIES™ SOLID/MECHANICAL LIFTERS WITH EDM INJECTION™ TECHNOLOGY

Our Performance Series™ Lifters with EDM Injection™ Technology have all of the same high-quality features as our Performance Series™ Solid/Mechanical Lifters with the addition of the EDM oiling hole on the lifter face.



MAKE	DESCRIPTION	DIAMETER	WEIGHT	SEAT HEIGHT	OIL BAND HEIGHT	OIL BAND WIDTH	PART #
AMC	V8 290-401 w/ .012" Oil Hole	.904"	101g	1.79"	1.06"	.35"	2901-16
Cadillac	V8 472-500 w/ .012" Oil Hole	.842"	86g	1.88"	1.10"	.41"	800-16
Chevrolet	V8 265-400 w/ .012" Oil Hole	.842"	86g	1.88"	1.10"	.41"	800-16
	V8 348-409 1958-65	.842"	86g	1.88"	1.10"	.41"	800-16
	V8 396-454 w/ .012" Oil Hole	.842"	86g	1.88"	1.10"	.41"	800-16
Chrysler	V8 273-360 w/ .012" Oil Hole	.904"	101g	1.79"	1.06"	.35"	2901-16¹
	V8 B-383-440 1958-Present w/ .012" Oil Hole	.904"	101g	1.79"	1.06"	.35"	2901-16¹
	V8 Hemi 426 w/ .012" Oil Hole	.904"	101g	1.79"	1.06"	.35"	2901-16¹
Ford	V8 302-351W 1969-Present w/ .012" Oil Hole	.875"	97g	1.95"	1.02"	.54"	817-16
	V8 Boss 302, 351C, 351M, 400M w/ .012" Oil Hole	.875"	97g	1.95"	1.02"	.54"	817-16
	V8 429-460 w/ .012" Oil Hole	.875"	97g	1.95"	1.02"	.54"	817-16
Pontiac	V8 260-455 w/ .012" Oil Hole	.842"	86g	1.88"	1.10"	.41"	800-16
Oldsmobile	V8 265-455 w/ .012" Oil Hole	.842"	86g	1.88"	1.10"	.41"	800-16
Universal	V8 Lightweight (No Chamfer) w/ .012" Oil Hole	.875"	79g	1.95"	1.00"	.53"	810-16

¹ Oils through pushrods

Note: For V6 applications, use -12 suffix.



BLACK OXIDED
OIL BAND

RETRO-FIT LINK BAR HYDRAULIC ROLLER LIFTERS *(Patent-Pending)*

- Precise piston fit for lowest leakdown rate
- Patent-pending piston allows trapped air to escape lifter for faster “pump up”
- Lightweight body design
- Axles produced from premium 52100 heat-treated steel for increased wear resistance & overall strength

OE-STYLE NO LINK BAR HYDRAULIC ROLLER LIFTERS

- Performance replacement for stock hydraulic roller lifters or retro-fit hydraulic roller lifters for non-roller blocks with the necessary hardware
- Decrease friction and increase longevity when compared to flat tappet lifters
- Accept much more aggressive cam profiles than flat tappet lifters will allow

MAKE	DESCRIPTION	DIAMETER	WEIGHT	SEAT HEIGHT	PART #
OE-STYLE NO LINK BAR HYDRAULIC ROLLER LIFTERS					
Chevrolet	Small Block 305 and 350, Use in Blocks Originally Equipped w/ Hydraulic Roller Cam (1987-Present Including LT1 & LS Series)	.842"	122g	2.66"	850-16
	Big Block Gen VI and 8.1L, Use in Blocks Originally Equipped w/ Hydraulic Roller Cam (1996-Present)	.842"	121g	2.66"	900-16
Ford	Small Block 302, Use in Blocks Originally Equipped w/ Hydraulic Roller Cam & COMP Cams® Ford Retro-Fit Kit for 289-302, 351W, 351C, 351M and 400M (see page 244)	.875"	135g	2.60"	851-16
RETRO-FIT LINK BAR HYDRAULIC ROLLER LIFTERS					
AMC	AMC 290-401, Retro-Fit Lifter for Early Model Blocks Originally Equipped w/ Flat Tappet Cam	.904"	145g	2.30"	8960-16
Buick	Buick 231 6 Cyl. Requiring Shrouded Wheel, Retro-Fit Roller Lifter for Early Model Blocks Originally Equipped w/ Flat Tappet Cam, Tall Body Fits Both Standard Blocks & Tall Lifter Bore Aftermarket Blocks	.842"	136g	2.47"	6853-12
Cadillac	Cadillac 425, 472, 500, Retro-Fit Lifter for Early Model Blocks Originally Equipped w/ Flat Tappet Cam	.842"	140g	2.49"	8962-16
Chevrolet	Small Block 265-400, Retro-Fit Roller Lifter for Early Model Blocks Originally Equipped w/ Flat Tappet Cam, Tall Body Fits Both Standard Blocks & Tall Lifter Bore Aftermarket Blocks	.842"	136g	2.47"	853-16
	Big Block 396-454, Retro-Fit Roller Lifter for Early Model Blocks Originally Equipped w/ Flat Tappet Cam, Tall Body Fits Both Standard Blocks & Tall Lifter Bore Aftermarket Blocks	.842"	137g	2.47"	854-16
	Big Block 348, 409, Retro-Fit Roller Lifter for Early Model Blocks Originally Equipped w/ Flat Tappet Cam, Tall Body Fits Both Standard Blocks & Tall Lifter Bore Aftermarket Blocks	.842"	136g	2.47"	8959-16
GM LS	LS Series Captured Link Bar Retro-Fit Roller Lifter for 1997-Up, Fits Factory, RHS®, LSX & Warhawk Blocks	.842"	140g	2.66"	8957-16
Chrysler	Small Block 273-360, Retro-Fit Roller Lifter for Early Model Blocks Originally Equipped w/ Flat Tappet Cam	.904"	141g	2.30"	8920-16
	Big Block 383-440, Retro-Fit Roller Lifter for Early Model Blocks Originally Equipped w/ Flat Tappet Cam	.904"	159g	2.30"	8921-16
Ford	Small Block 289-302-351W, Retro-Fit Roller Lifter for Early Model Blocks Originally Equipped w/ Flat Tappet Cam	.875"	146g	2.60"	8931-16
	Big Block & FE 390-428, 429, 460, Retro-Fit Roller Lifter for Early Model Blocks Originally Equipped w/ Flat Tappet Cam	.875"	147g	2.60"	8934-16
Oldsmobile & Pontiac	Oldsmobile & Pontiac, Retro-Fit Roller Lifter for Blocks Originally Equipped w/ Flat Tappet Cam (Will Not Clear Stock Intake on Small Block Oldsmobile or Edelbrock #3711 Intake)	.842"	136g	2.47"	857-16

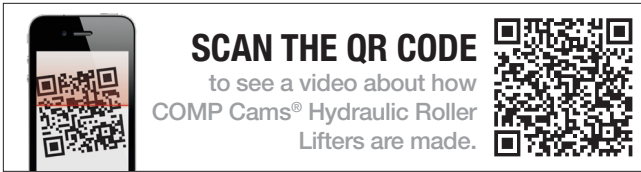

ALL COMP CAMS® SHORT TRAVEL LINK BAR TYPE LIFTERS ARE IDENTIFI-
FABLE DUE TO THEIR BLACK OXIDED BODIES (AFTER GRIND AND POLISH).
FULL TRAVEL LIFTERS ARE ONLY BLACK OXIDED IN THE OIL BAND.

ROLLER LIFTER CROSS SECTION

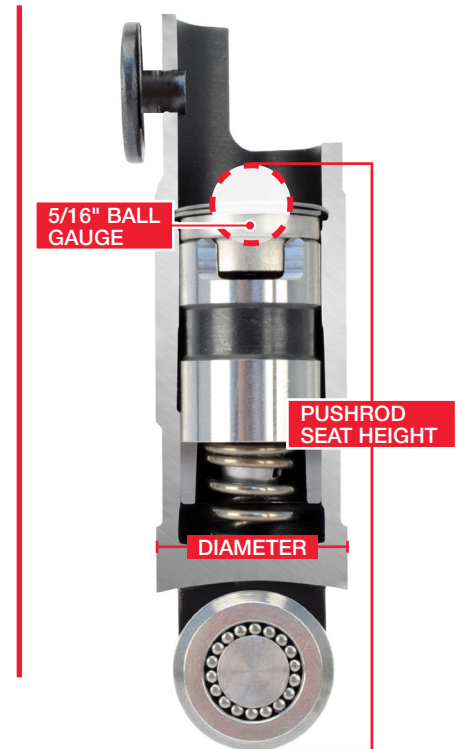

SHORT TRAVEL HYDRAULIC ROLLER LIFTERS (Patent Pending)

When dealing with full travel lifters, certain engines respond better to a light pre-load because it recovers more quickly from any bad harmonics in the valve train. Others work better with a heavy pre-load because oil volume is reduced under the plunger, which increases stiffness. COMP Cams® Short Travel Hydraulic Roller Lifters allow you to have the advantages of both light pre-load and reduced oil volume, producing the most stable and highest revving hydraulic lifter available.

MAKE	DESCRIPTION	DIAMETER	WEIGHT	SEAT HEIGHT	PART #
OE-STYLE NO LINK BAR HYDRAULIC ROLLER LIFTERS					
Chevrolet	Small Block 305 & 350, Use in Blocks Originally Equipped w/ Hydraulic Roller Cam (1987-Present Including LT1 & LS Series), Reduced Travel, OE Guide	.842"	122g	2.60"	875-16
	Small Block 305 & 350, Use in Blocks Originally Equipped w/ Hydraulic Roller Cam (1987-Present Including LT1 & LS Series), Short Travel, OE Guide	.842"	132g	2.66"	15850-16
Ford	Small Block 302, Use in Blocks Originally Equipped w/ Hydraulic Roller Cam and in COMP Cams® Specially Designed Ford Retro-Fit Kit for 289-302, 351W, 351C, 351M and 400M, Reduced Travel, OE Guide	.875"	128g	2.60"	877-16
RETRO-FIT LINK BAR HYDRAULIC ROLLER LIFTERS					
Chevrolet	Small Block 265-400, Retro-Fit Roller Lifter for Early Model Blocks Originally Equipped w/ Flat Tappet Cam, Tall Body Fits Both Standard Blocks & Tall Lifter Bore Aftermarket Blocks, Short Travel, Link Bar Guide	.842"	152g	2.66"	15853-16
	Big Block 396-454, Retro-Fit Roller Lifter For Early Model Blocks Originally Equipped w/ Flat Tappet Cam, Tall Body Fits Both Standard Blocks & Tall Lifter Bore Aftermarket Blocks, Short Travel, Link Bar Guide	.842"	150g	2.66"	15854-16
GM LS	LS Series Captured Link Bar Retro-Fit Roller Lifter for 1997-Present, Fits Factory, RHS®, LSX & Warhawk Blocks, Short Travel, Link Bar Guide	.842"	145g	2.66"	15956-16
Ford	Small Block 289-302-351W Retro-Fit Roller Lifter for Early Model Blocks Originally Equipped with Flat Tappet Cams, Short Travel, Link Bar Guide	.875"	158g	2.60"	15931-16

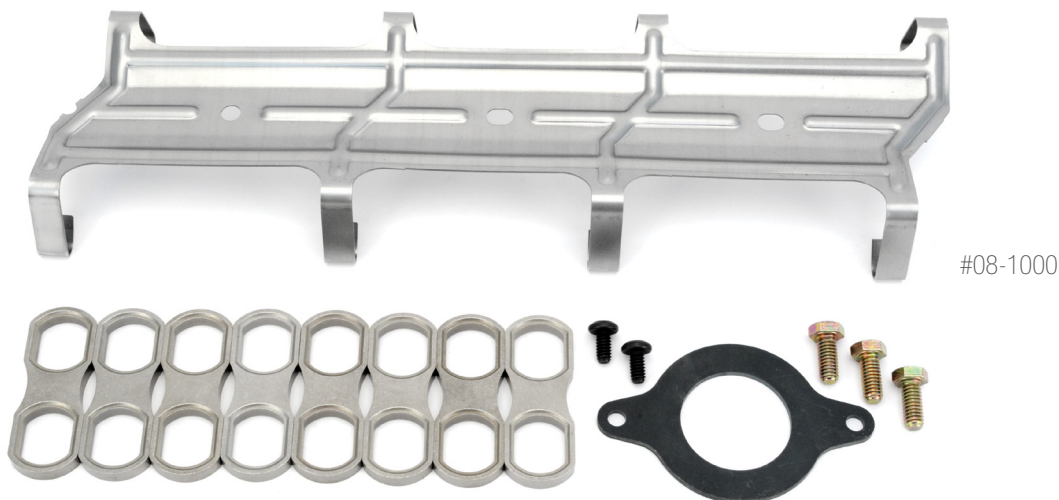

#08-1000

HYDRAULIC ROLLER LIFTER INSTALLATION KITS

COMP Cams® has put together these time-saving kits that contain all of the necessary pieces to help you smoothly install hydraulic roller lifters in your V6 or V8 block originally equipped with a hydraulic roller cam. Each kit contains all required hardware and all components are new.

- Convenient solution for installation of hydraulic roller lifters in V6 or V8 blocks equipped with hydraulic roller cams
- Contain cam bolts, lifter guides, lifter retainer, cam retainer and cam retainer bolts (except where noted)
- Detailed instructions and all hardware required for installation are included

FORD HYDRAULIC ROLLER RETRO-FIT KIT

This Ford Hydraulic Roller Retro-Fit Kit contains the pieces required to install our complete line of hydraulic roller cams in 302, 351W, 351C and 351M-400 Ford engines that did not come with an OEM hydraulic roller cam. This kit ships complete with detailed instructions and all necessary hardware.

- Works on all Small Block Ford engines originally equipped with a flat tappet or roller cam
- When being used in a non-roller block, a small base circle retro-fit cam must be used to ensure the lifters will not expose the oil hole or band out of the lifter bores
- Must be used with Part #851-16 or #877-16 lifters

MAKE	DESCRIPTION	KIT CONTAINS:	PART #
Chevrolet	Chevy V6 4.3L w/ Balance Shaft (Except 1994-Present w/ Plastic Lifter Guides)	(3) #4605-B Camshaft Bolts	09-1000
		(6) #8105-LG Lifter Guides	
	(1) #8106-LR Lifter Retainer		
	(1) #8106-CR Cam Retainer		
	Chevy V6 4.3L w/o Balance Shaft (Except 1985-86 w/ Hyd. Roller Cam)	(2) #8106-B Cam Retainer Bolts	09-1001¹
		(6) #8105-LG Lifter Guides	
	Chevy Small Block 1987-93 Non-Vortec V8 305 & 350 w/ OE Hyd. Roller Cam	(1) #8105-CR Cam Retainer	08-1000
		(2) #8105-B Cam Retainer Bolts	
	(3) #4605-B Camshaft Bolts	08-1001	
	(8) #8105-LG Lifter Guides		
	Chevy Small Block 1991-02 Vortec Engines, 1991-97 LT1	(1) #8105-LR Lifter Retainer	08-1001
		(1) #8105-CR Cam Retainer	
	(2) #8105-B Cam Retainer Bolts	31-1000	
	(8) #8135-LG Lifter Guides		
Ford	302 HD, 5.0	(1) #8135-LR Lifter Retainer	31-1000
		(2) #8135-B Cam Retainer Bolts	
RETRO-FIT			
Ford	Small Block 289-302, 351W, 351C, 351M-400M	(8) #8135-LG Lifter Guides	31-1000
		(1) #8135-LR Lifter Retainer	
		(2) #8135-CS Cap Screws	

¹ Lifter retainer is not available for this engine



#31-1000

ENDURE-X™ SOLID ROLLER LIFTERS

Today's engines place a greater demand on lifters than ever before. With today's more aggressive cam lobe designs and increased RPM ranges, it takes a superior roller lifter to withstand the abuse. COMP Cams® has set the industry standard with the Endure-X™ Solid Roller Lifters.

Endure-X™ Lifters are fully heat-treated, machined to ultra-high tolerances, are fully rebuildable and are available for a wide variety of applications, including small base circle and offset applications.

THE FOUR MAIN FEATURES OF ENDURE-X™ SOLID ROLLER LIFTERS:

- 1. REMOVABLE LINK BAR** – COMP Cams® patented link bar assembly combines the benefits of a removable link bar with the safety of a captured link bar.
- 2. EDM OIL INJECTION™ TECHNOLOGY** – Guarantees that the bearing assembly receives a constant flow of pressurized oil via a precision hole aimed directly at the needle bearings.
- 3. PRECISION SORTED BEARINGS** – The needle bearings are precision sorted by size to distribute load evenly, preventing premature wear and failure.
- 4. TOOL STEEL AXLE** – The axle is made of wear resistant Tool Steel to prolong the life of the roller assembly, particularly in high RPM applications.



ENDURE-X™ SOLID ROLLER LIFTER REBUILD PROGRAM

Today's roller lifters face grueling engine environments. COMP Cams® recognizes the high cost of new parts and designed the Endure-X™ Lifter Rebuild Program to help offset some of that cost.

There is a small fee to replace worn or damaged parts and replacement lifters may be purchased to replace defective or destroyed ones.

DESCRIPTION	PART #
For .750" Wheel Diameter	800-RB1-1
For .850" Wheel Diameter	800-RB2-1



REBUILT SOLID ROLLER LIFTERS GO THROUGH THE FOLLOWING STEPS:

1. Lifter bodies are disassembled and inspected for cracks.
2. Retaining grooves are inspected and cleaned.
3. Lifter bodies are thoroughly washed.
4. A new axle and roller assembly are pressed into the body, and new retaining clips are installed.
5. Lifters are reboxed and returned to the customer.



STYLE A
Cutaway – Oil Band



STYLE B
Solid – Oil Band



STYLE C
Cutaway – Solid



STYLE D
Solid

DETERMINING OFFSET

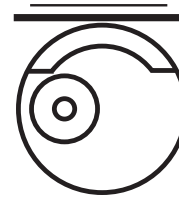

Left Offset

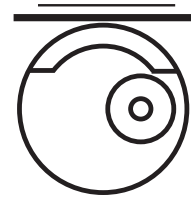

Right Offset

Note: On offset lifters, offset is determined by looking at the lifter with the link bar away from you.

ENDURE-X™ SOLID ROLLER LIFTERS

DESCRIPTION	DIA.	WEIGHT	SET INCLUDES:		PUSHROD SEAT LOCATION	OIL HOLE VS. AXLE	SEAT HEIGHT	PART #/ STYLE
			LIFTERS	LINK BARS				
AMERICAN MOTORS V8 290-401 1966-89								
Baseline Coverage for All Types of Motorsports Using the AMC Engine	.904"	136g	(16) 861-1	(8) 839-L	All Centered	Parallel	1.91"	861-16 Style A
BUICK V6								
Best for Any Application When a Centered Pushrod Can Be Used	.842"	119g	(12) 818-1	(5) 818-L (1) 814-L	All Centered	Perpendicular	1.88"	868-12 Style B
For Engines that Oil Through Rocker Arm Shafts, Not Through Pushrods	.842"	110g	(12) 868S-1	(5) 818-L (1) 814-L	All Centered	N/A	1.30"	868S-12 Style D
CHEVROLET 90° V6 (RACE)								
Best All Around Set When a Centered Pushrod Can Be Used	.842"	119g	(12) 818-1	(6) 818-L	All Centered	Perpendicular	1.88"	818-12 Style B
Use When an Offset Intake Pushrod Set Is Required for Clearance, Centered Exhaust	.842"	114g	(6) 894C-1 (2) 894R-1 (4) 894L-1	(4) 818-L (2) 814-L	(6) Centered (2) Rights (4) Lefts	Perpendicular	1.88"	897-12 Style A
CHEVROLET V8 265-400 (*DENOTES TAPPETS FOR 1987-CURRENT, BOWTIE & SOME AFTERMARKET BLOCKS W/ TALLER LIFTER BORES)								
Great for Any Application w/ Enlarged Lifter Bores, Ford Diameter	.875"	127g	(16) 815-1	(8) 818-L	All Centered	Perpendicular	1.88"	815-16 Style B
Perfect Roller Lifter for Any Application w/ No Offsets	.842"	119g	(16) 818-1	(8) 818-L	All Centered	Perpendicular	1.88"	818-16 Style B
Full Body Style of #873-16 .300" Taller Body for 1987 & Up, Bowtie & Most Aluminum Blocks	.842"	138g	(16) 871-1	(8) 818-L	All Centered	Perpendicular	1.88"	871-16 Style B
.300" Taller Body for 1987 & Up, Bowtie & Most Aluminum Blocks	.842"	117g	(16) 873-1	(8) 818-L	All Centered	Perpendicular	1.88"	873-16 Style A
.300" Taller Body Lifters Designed for Street & Marine Applications	.842"	116g	(16) 888-1	(8) 818-L	All Centered	Perpendicular	1.88"	888-16 Style A
.300" Taller Body Lifters w/ Offset Intakes for Additional Clearance & Enlarged Lifter Bores	.875"	136g	(8) 890C-1 (4) 890R-1 (4) 890L-1	(8) 818-L	(8) Centered (4) Rights (4) Lefts	Perpendicular	1.88"	890-16 Style A
Specifically Engineered for Any Application Using Small Base Circle Cams	.842"	122g	(16) 891-1	(8) 818-L	All Centered	Perpendicular	1.88"	891-16 Style B
A Proven Winner When Offset Intakes are Necessary for More Pushrod Clearance	.842"	114g	(8) 894C-1 (4) 894R-1 (4) 894L-1	(8) 818-L	(8) Centered (4) Rights (4) Lefts	Perpendicular	1.88"	894-16 Style A
.300" Taller Offset Lifters	.842"	117g	(8) 873-1 (4) 873R-1 (4) 873L-1	(8) 818-L	(8) Centered (4) Rights (4) Lefts	Perpendicular	1.88"	8995-16 Style A
CHEVROLET V8 SB2								
SB2 Block, SB2 Head .300" Tall Lifters w/ .874" Lifter Bore, Centered Pushrod Seats	.875"	122g	(16) 890C-1	(4) 0894-L (4) 0895-L	(16) Centered	Perpendicular	1.88"	8991-16 Style A
Standard GM Block, SB2 Head .300" Tall Offset .842" Lifter Bore, Offset Pushrod Seat	.842"	114g	(8) 894L-1 (8) 894R-1	(8) 818-L	(8) Lefts (8) Rights	Perpendicular	1.88"	8992-16 Style A
Standard GM Block, SB2 Head .300" Tall Offset .875" Lifter Bore, Offset Pushrod Seat	.875"	122g	(8) 890L-1 (8) 890R-1	(8) 818-L	(8) Lefts (8) Rights	Perpendicular	1.88"	8993-16 Style A

DESCRIPTION	DIA.	WEIGHT	SET INCLUDES:		PUSHROD SEAT LOCATION	OIL HOLE VS. AXLE	SEAT HEIGHT	PART #/ STYLE
			LIFTERS	LINK BARS				
GM GEN III/LS1/LS2/LS6/LS7/LSX								
GM Gen III/LS1/LS2/LS6 Solid Roller Lifters – Not Designed for Street Use	.842"	118g	(16) 8956-1	(8) 838-L	(16) Centered	Perpendicular	2.01"	8956-16 Style A
GM Solid Roller Lifters for LSX/Warhawk Block	.842"	118g	(16) 8956-1	(8) 8958-L	(16) Centered	Perpendicular	2.01"	8958-16 Style A
CHEVROLET V8 396-454 1965-96								
Perfect for Any Application w/ No Offsets	.842"	118g	(16) 819-1	(8) 819-L	All Centered	Perpendicular	1.88"	819-16 Style B
Great for Any Application w/ Enlarged Lifter Bores, Ford Diameter	.875"	127g	(16) 815-1	(8) 819-L	All Centered	Perpendicular	1.88"	823-16 Style B
.300" Taller Body Designed for Street & Marine Applications	.842"	116g	(16) 888-1	(8) 873-L	All Centered	Perpendicular	1.88"	866-16 Style A
.300" Taller Body for Late Model, Bowtie & Most Aluminum Blocks	.842"	117g	(16) 873-1	(8) 873-L	All Centered	Perpendicular	1.88"	883-16 Style A
Specifically Engineered for Any Application Using Small Base Circle Cams	.842"	122g	(16) 891-1	(8) 819-L	All Centered	Perpendicular	1.88"	893-16 Style B
Most Durable Set When Right Offsets Are Necessary for More Pushrod Clearance	.842"	114g	(8) 894C-1 (8) 894R-1	(8) 819-L	(8) Centered (8) Rights	Perpendicular	1.88"	895-16 Style A
Best When Cutaway Style Lifter Bodies Are Necessary for Improved Clearance	.842"	114g	(16) 894C-1	(8) 819-L	All Centered	Perpendicular	1.88"	897-16 Style A
Best Available Lifters When Left Offsets Are Necessary for More Pushrod Clearance	.842"	114g	(8) 894C-1 (8) 894L-1	(8) 819-L	(8) Centered (8) Lefts	Perpendicular	1.88"	898-16 Style A
Proven Winner When Offset Intakes Are Necessary for More Pushrod Clearance	.842"	114g	(8) 894C-1 (4) 894R-1 (4) 894L-1	(8) 819-L	(8) Centered (4) Rights (4) Lefts	Perpendicular	1.88"	899-16 Style A
.300" Taller Cutaway Offset Lifters for Any Application w/ Extreme Pushrod Angles	.842"	117g	(8) 873-1 (4) 873R-1 (4) 873L-1	(8) 873-L	(8) Centered (4) Rights (4) Lefts	Perpendicular	1.88"	8996-16 Style A
CHRYSLER V8 273-360								
Best All Around Lifter for Engines That Oil Through Rocker Shafts, No Oil Hole	.904"	125g	(8) 828-2	Captured	All Centered	N/A	1.79"	828-16 Style C
Solid Roller Lifters w/ Oiling & Inboard Link Bars	.904"	132g	(8) 8043-2	Captured	All Centered	Parallel	1.93"	8043-16 Style A
CHRYSLER V8 383-440 & 426 HEMI								
Note: "Fat Head" Spread Lifter Bore Requires Special Ordering (8) Link Bars #839-L								
Standard Pushrod Seat Location, Best for Performance Street & Drag Racing	.904"	127g	(16) 829-1	(8) 829-L	All Centered	N/A	1.79"	829-16 Style C
Pushrod Seat Is Located .140" Deeper Than Standard Location	.904"	122g	(16) 830-1	(8) 829-L	All Centered	N/A	1.65"	830-16 Style C
.300" Tall Offset Lifters for Engines That Oil Through Rocker Shafts, No Oil Hole	.904"	135g	(8) 87016C-1 (4) 87018R-1 (4) 87017L-1	(8) 829-L	(8) Centered (4) Rights (4) Lefts	N/A	1.91"	87019-16 Style A
FORD V8 289-351W								
Note: 289 & 302 Require Cylinder Head Removal to Install Lifters								
Best All Around Lifter Available, Perfect for Any Application w/ No Offsets	.875"	134g	(16) 838-1	(8) 838-L	All Centered	Perpendicular	2.01"	838-16 Style B
FORD V8 SVO SMALL BLOCK DRAG RACE APPLICATIONS W/ YATES HEADS								
Lifter Designed for Drag Race Applications Using Yates Heads	.875"	236g ¹	(8) 87879-2	Captured	(8) Centered (8) Rights .180"	Parallel	2.02"	87879-16 Style A
FORD V8 351C, 351M, 400M								
Note: W/ 5/16" Pushrods Only								
Perfect Lifter for Cleveland Applications w/ No Offsets Necessary	.875"	134g	(16) 836-1	(8) 838-L	All Centered	Parallel	2.01"	840-16 Style B

¹ Denotes weight of a pair of lifters, including link bar.

ENDURE-X™ SOLID ROLLER LIFTERS *(continued)*

DESCRIPTION	DIA.	WEIGHT	SET INCLUDES:		PUSHROD SEAT LOCATION	OIL HOLE VS. AXLE	SEAT HEIGHT	PART #/ STYLE
			LIFTERS	LINK BARS				
FORD V8 352-428								
The Best FE Mechanical Roller Available, Works in Any High Performance Application	.875	134g	(16) 838-1	(8) 839-L	All Centered	Perpendicular	2.01	839-16
FORD V8 429-460								
Our Most Durable Lifter Set, Fits Most Combinations in Any Application	.875"	134g	(16) 836-1	(8) 836-L	All Centered	Parallel	2.01"	836-16 Style B
The Same Durable Design Incorporated w/ a Unique Captured Link Bar System, for Most Hemi Type Fords	.875"	108g	(8) 841-2	Captured	All Centered	Parallel	2.01"	841-16 Style A
Special Arranged Set Featuring a Captured Link Bar Design w/ an Offset Intake	.875"	112g	(8) 879-2	Captured	(8) Centered (8) Rights .180"	Parallel	2.01"	879-16 Style A
HOLDEN V8								
The Best & Only Set Available for the Holden, Works in Any Application	.842"	120g	(16) 881-1	(8) 829-L	All Centered	Parallel	2.01"	881-16 Style A
OLDSMOBILE V8 350-455								
The Perfect Lifter for Street, Drag & Marine When No Offset is Necessary	.842"	120g	(16) 859-1	(8) 829-L	All Centered	Parallel	2.01"	849-16 Style B
PONTIAC V8 350-455								
The Best Choice for All Engine Sizes in Any Application, Especially Performance Street	.842"	120g	(16) 859-1	(8) 829-L	All Centered	Parallel	2.01"	859-16 Style A

ENDURE-X™ SINGLE SOLID ROLLER LIFTERS

DESCRIPTION	DIA.	WEIGHT	PUSHROD SEAT LOCATION	OFFSET DISTANCE	OIL HOLE VS. AXLE	WHEEL DIAMETER	SEAT HEIGHT	PART #/ STYLE
Roller Lifter	.842"	114g	Centered	0	Perpendicular	.750"	1.88"	894C-1 Style A
Roller Lifter	.842"	114g	Left	.180"	Perpendicular	.750"	1.88"	894L-1 Style A
Roller Lifter	.842"	114g	Right	.180"	Perpendicular	.750"	1.88"	894R-1 Style A
.300" Tall Roller Lifter	.842"	117g	Centered	0	Perpendicular	.750"	1.88"	873-1 Style A
.300" Tall Roller Lifter	.842"	117g	Left	.180"	Perpendicular	.750"	1.88"	873L-1 Style A
.300" Tall Roller Lifter	.842"	117g	Right	.180"	Perpendicular	.750"	1.88"	873R-1 Style A
.300" Tall Roller Lifter	.875"	122g	Centered	0	Perpendicular	.750"	1.88"	890C-1 Style A
.300" Tall Roller Lifter	.875"	122g	Left	.180"	Perpendicular	.750"	1.88"	890L-1 Style A
.300" Tall Roller Lifter	.875"	122g	Right	.180"	Perpendicular	.750"	1.88"	890R-1 Style A
.300" Tall Roller Lifter	.904"	133g	Centered	0	Perpendicular	.800"	1.91"	892C-1 Style A
.300" Tall Roller Lifter	.904"	133g	Left	.210"	Perpendicular	.800"	1.91"	892L-1 Style A
.300" Tall Roller Lifter	.904"	133g	Right	.210"	Perpendicular	.800"	1.91"	892R-1 Style A
.300" Tall Roller Lifter w/o Oil Hole	.904"	135g	Centered	.210"	N/A	.800"	1.91"	87016C-1 Style A
.300" Tall Roller Lifter w/o Oil Hole	.904"	135g	Left	.210"	N/A	.800"	1.91"	87017L-1 Style A
.300" Tall Roller Lifter w/o Oil Hole	.904"	135g	Right	.210"	N/A	.800"	1.91"	87018R-1 Style A



ROLLER LIFTER LINK BARS

COMP Cams® Roller Lifter Link Bars are precision-crafted from stainless steel and wear-coated for a long life in all applications.

DESCRIPTION	LIFTER BORE CENTERLINE	A	B	C	PART #
FLAT STYLE					
Chevrolet Small Block	1.560"				
Chevrolet V6 Cylinders #1, #2, #5 & #6	1.560"	1.350"	2.380"	2.000"	818-L
Buick V6 Cylinders #1, #2, #4, #5 & #6	1.525"				
Chevrolet V6 Cylinders #3 & #4	1.660"	1.475"	2.500"	2.125"	814-L
Buick V6 Cylinder #3	1.610"				
GM Gen III/LS1/LS2/LS6	1.730"	1.564"	2.594"	2.214"	838-L
Ford Small Block 289-302, 351W, SVO 351	1.730"				
Ford Big Block 429-460	2.075"	2.019"	3.044"	2.669"	836-L
Chrysler 426-440	1.800"				
Pontiac 350-455	1.818"	1.654"	2.680"	2.295"	829-L
Oldsmobile 350-455	1.877"				
AMC 360-401	1.940"				
F.E. Style Ford 392-428	1.980"	1.884"	2.910"	2.534"	839-L
Chrysler "Fat Head"	2.000"				
"V" STYLE					
GM LS for LSX/Warhawk/RHS®/Factory Block	1.827"	1.500"	2.470"	2.340"	8958-L
"STEPPED" STYLE					
Chevrolet Big Block 396-454	1.800"	1.560"	2.610"	2.250"	819-L
Chevrolet Big Block 396-454 for .300" Tall Lifters	1.800"	1.560"	2.610"	2.250"	873-L
GM SB2 Cylinders #1 & #3	1.835"	1.614"	2.679"	2.304"	0894-L
GM SB2 Cylinders #2 & #4	1.834"	1.614"	2.679"	2.304"	0895-L
GM SB2 Cylinders #5 & #7	1.812"	1.614"	2.679"	2.304"	0895-L
GM SB2 Cylinders #6 & #8	1.813"	1.614"	2.679"	2.304"	0894-L

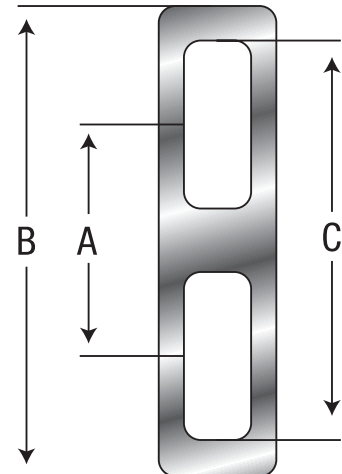

Note: Dimensions are listed for popular applications. Other applications available.

TECH TIP

To ensure you're using the best lifters possible with your camshaft, select a CL-Kit. A CL-Kit is a cam and lifter kit that includes your selected camshaft and perfectly matched lifters. Find your camshaft in the Master Cam Charts (beginning on page 8) in this catalog to see if a CL-Kit is available for your application.

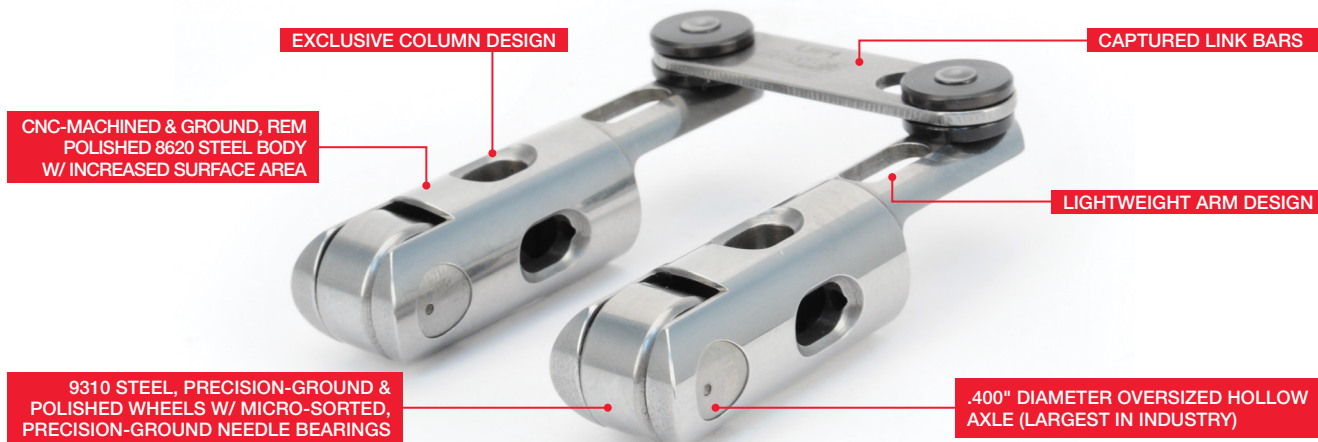

ELITE RACE™ SOLID ROLLER LIFTERS

(Patent Pending Oil Control)

If you're looking for the ultimate lifter to withstand even the most demanding racing conditions, look no further. The COMP Cams® Elite Race™ Lifters feature a host of advantages over competing race lifter designs, including an SAE 8620 stainless steel alloy body that is CNC-machined and REM-finished, SAE 9310 steel alloy wheels that are micro-polished and micro-sized and needles that are made from 52100 bearing steel and micro-sorted with a controlled contour profile.

These lifters feature an exclusive body design that does not include an oil band, maximizing rigidity and reducing lifter bushing wear. While the construction and body design make them incredibly strong, the Elite Race™ Lifters are also lightweight, with each lifter weighing less than 100 grams individually. All lifter bodies are "tall" and will clear both stock and aftermarket .300" tall lifter bores and will properly fit either 5/16" or 3/8" ball pushrods.

One of the most critical elements of this lifter design is the fact that the oversized (.400") axles are pinned and feature an internal oil passage for direct pressurized oiling to the needles. And with this pressure fed oiling you get wear-reducing engine lubrication when and where you need it the most. The oil actually flows through the center and the top of the axle – directly to the needles.

For maximum control and durability in high-RPM race applications, these lifters also feature captured link bars and an exclusive modular pushrod seat design that allows the pushrod insert to be swapped out for centered, left or right offsets. And with our patent-pending oil control through the pushrod insert, engine builders can modify the lifter to meter extra oil to the top as desired.

Elite Race™ Lifters are fully heat-treated, machined to high tolerances and are available for a number of Chevy, Ford and Chrysler applications. A complete application listing is on the following pages.

THE FOUR MAIN FEATURES OF ELITE RACE™ SOLID ROLLER LIFTERS:

- 1. MODULAR DESIGN** – Pushrod seat insert can be changed for centered, left or right offsets. A patent-pending design allowing oil control through the pushrod insert lets builders modify lifters to meter extra oil to the top.
- 2. TOOL STEEL, PINNED AXLES** – .400" Axles (extra large for maximum load support) allow for extra needle bearings (total of 23) for optimum load distribution. Needles are constructed from 52100 bearing steel and are micro-sorted with a contoured profile.
- 3. PRESSURE-FED OILING** – Center and top axle oil outlets for lubrication through the axle, directly to the needles – exactly where you need it.
- 4. CAPTURED LINK BARS** – Designed specifically for race and high-RPM applications, captured link bars offer maximum control and durability.



PATH OF PRESSURIZED OIL

ELITE RACE™ SOLID ROLLER LIFTERS

DESCRIPTION	DIAMETER	WEIGHT	SET INCLUDES:	PUSHROD SEAT LOCATION	WHEEL DIAMETER	SEAT HEIGHT	PART #
SMALL BLOCK CHEVROLET V8 265-400 *LIFTER BORE SPACING MIN. 1.435" & MAX. @ .450" LIFT IS 1.700/@.500" LIFT IS 1.670"							
Roller Lifters	.842"	99g	(8) 98842C-2	8 Pairs Centered	.750"	1.91"	98818-16
.160" Offset Roller Lifters	.842"	99g	(4) 98842CL-2 (4) 98842CR-2	4 Pairs Centered & Left 4 Pairs Centered & Right	.750"	1.91"	98894-16
Roller Lifters for Applications w/ Enlarged Lifter Bores (.875")	.875"	102g	(8) 98875C-2	8 Pairs Centered	.785"	1.93"	98815-16
.160" Offset Roller Lifters for Applications w/ Enlarged Lifter Bores (.875")	.875"	102g	(4) 98875CL-2 (4) 98875CR-2	4 Pairs Centered & Left 4 Pairs Centered & Right	.785"	1.93"	98890-16
Roller Lifters for Applications w/ Enlarged Lifter Bores (.904")	.904"	102g	(8) 98904C-2	8 Pairs Centered	.820"	1.95"	98891-16
.180" Offset Roller Lifters for Applications w/ Enlarged Lifter Bores (.904")	.904"	102g	(4) 98904CL-2 (4) 98904CR-2	4 Pairs Centered & Left 4 Pairs Centered & Right	.820"	1.95"	98892-16
.180" Offset Roller Lifters for Applications w/ Enlarged Lifter Bores (.904")	.904"	102g	(8) 98904LR-2	8 Pairs Left & Right	.820"	1.95"	98893-16
BIG BLOCK CHEVROLET V8 396-454 *LIFTER BORE SPACING MIN. 1.765 & MAX. @ .450" LIFT IS 2.040/@.500" LIFT IS 2.020							
Roller Lifters	.842"	99g	(8) 98852C-2	8 Pairs Centered	.750"	1.91"	98819-16
.160" Offset Roller Lifters	.842"	99g	(4) 98852CL-2 (4) 98852CR-2	4 Pairs Centered & Left 4 Pairs Centered & Right	.750"	1.91"	98996-16
Roller Lifters for Applications w/ Enlarged Lifter Bores (.875")	.875"	102g	(8) 98851C-2	8 Pairs Centered	.785"	1.94"	98823-16
.160" Offset Roller Lifters for Applications w/ Enlarged Lifter Bores (.875")	.875"	102g	(4) 98851CL-2 (4) 98851CR-2	4 Pairs Centered & Left 4 Pairs Centered & Right	.785"	1.94"	98997-16
Roller Lifters for Applications w/ Enlarged Lifter Bores (.904")	.904"	102g	(8) 98850C-2	8 Pairs Centered	.820"	1.95"	98995-16
.180" Offset Roller Lifters for Applications w/ Enlarged Lifter Bores (.904")	.904"	102g	(4) 98850CL-2 (4) 98850CR-2	4 Pairs Centered & Left 4 Pairs Centered & Right	.820"	1.95"	98998-16
.180" Offset Roller Lifters for Applications w/ Enlarged Lifter Bores (.904")	.904"	102g	(8) 98850LR-2	8 Pairs Left & Right	.820"	1.95"	98999-16
LS SERIES, GM GEN III/IV *LIFTER BORE SPACING MIN. 1.700 & MAX. @ .450" LIFT IS 1.975/@.500" LIFT IS 1.950							
Roller Lifters	.842"	99g	(8) 98956C-2	8 Pairs Centered	.750"	2.22"	98956-16
CHRYSLER V8 383-440 *LIFTER BORE SPACING MIN. 1.840 & MAX. @ .450" LIFT IS 2.120/@.500" LIFT IS 2.000							
Roller Lifters	.904"	102g	(8) 98829C-2	8 Pairs Centered	.820"	1.95"	98829-16
.180" Offset Roller Lifters	.904"	102g	(4) 98829CL-2 (4) 98829CR-2	4 Pairs Centered & Left 4 Pairs Centered & Right	.820"	1.95"	98827-16
FORD V8 289-351W *LIFTER BORE SPACING MIN. 1.700 & MAX. @ .450" LIFT IS 1.975/@.500" LIFT IS 1.950							
Roller Lifters	.875"	102g	(8) 98838C-2	8 Pairs Centered	.785"	1.93"	98838-16
.160" Offset Roller Lifters	.875"	102g	(8) 98838CR-2	8 Pairs Centered & Right	.785"	1.93"	98837-16
.180" Offset Roller Lifters for Applications w/ Enlarged Lifter Bores (.904")	.904"	102g	(8) 98835CR-2	8 Pairs Centered & Right	.820"	1.95"	98835-16
FORD V8 352-428 & 429-460 *LIFTER BORE SPACING MIN. 1.840 & MAX. @ .450" LIFT IS 2.120/@.500" LIFT IS 2.000							
Roller Lifters	.875"	102g	(8) 98836C-2	8 Pairs Centered	.785"	1.93"	98836-16
Roller Lifters for Applications w/ Enlarged Lifter Bores (.904")	.904"	102g	(8) 98839C-2	8 Pairs Centered	.820"	1.95"	98839-16

* The notes list the minimum allowable lifter bore spacing for each of the given Elite Race™ link bars, along with the maximum allowable spacing for .450" & .550" lift lobe applications. With internal oiling, the Elite Race™ design can be used in many non-listed applications, and this spacing information can be used to select the correct configuration.

CUSTOM ENGINE BUILDS - Lifter sets and are pairs also available without pushrod seat inserts installed. Please call 1-800-999-0853 or email camhelp@compcams.com for part numbers.

ELITE RACE™ INDIVIDUAL PAIRS W/ CAPTURED LINK BAR

DESCRIPTION	DIAMETER	WEIGHT	PUSHROD SEAT LOCATION	OFFSET DISTANCE	WHEEL DIAMETER	SEAT HEIGHT	PART #
SMALL BLOCK CHEVROLET V8 265-400 *LIFTER BORE SPACING MIN. 1.435" & MAX. @ .450" LIFT IS 1.700"/@.500" LIFT IS 1.670"							
Roller Lifter Pair – Both Centered	.842"	99g	Both Centered	0	.750"	1.91"	98842C-2
Roller Lifter Pair – One Centered & One Offset Left	.842"	99g	Centered & Left	0, .160"	.750"	1.91"	98842CL-2
Roller Lifter Pair – One Centered & One Offset Right	.842"	99g	Centered & Right	0, .160"	.750"	1.91"	98842CR-2
Roller Lifter Pair – One Offset Left & One Offset Right	.842"	99g	Left & Right	.160", .160"	.750"	1.91"	98842LR-2
Roller Lifter Pair – Both Centered – For Enlarged Lifter Bores (.875")	.875"	102g	Both Centered	0	.785"	1.93"	98875C-2
Roller Lifter Pair – One Centered & One Offset Left – For Enlarged Lifter Bores (.875")	.875"	102g	Centered & Left	0, .160"	.785"	1.93"	98875CL-2
Roller Lifter Pair – One Centered & One Offset Right – For Enlarged Lifter Bores (.875")	.875"	102g	Centered & Right	0, .160"	.785"	1.93"	98875CR-2
Roller Lifter Pair – One Offset Left & One Offset Right – For Enlarged Lifter Bores (.875")	.875"	102g	Left & Right	.160", .160"	.785"	1.93"	98875LR-2
Roller Lifter Pair – Both Centered – For Enlarged Lifter Bores (.904")	.904"	102g	Both Centered	0	.820"	1.95"	98904C-2
Roller Lifter Pair – One Centered & One Offset Left – For Enlarged Lifter Bores (.904")	.904"	102g	Centered & Left	0, .180"	.820"	1.95"	98904CL-2
Roller Lifter Pair – One Centered & One Offset Right – For Enlarged Lifter Bores (.904")	.904"	102g	Centered & Right	0, .180"	.820"	1.95"	98904CR-2
Roller Lifter Pair – One Offset Left & One Offset Right – For Enlarged Lifter Bores (.904")	.904"	102g	Left & Right	.180", .180"	.820"	1.95"	98904LR-2
BIG BLOCK CHEVROLET V8 396-454 1965-1996 *LIFTER BORE SPACING MIN. 1.765" & MAX. @ .450" LIFT IS 2.040"/@.500" LIFT IS 2.020"							
Roller Lifter Pair – Both Centered	.842"	99g	Both Centered	0	.750"	1.91"	98852C-2
Roller Lifter Pair – One Centered & One Offset Left	.842"	99g	Centered & Left	0, .160"	.750"	1.91"	98852CL-2
Roller Lifter Pair – One Centered & One Offset Right	.842"	99g	Centered & Right	0, .160"	.750"	1.91"	98852CR-2
Roller Lifter Pair – One Offset Left & One Offset Right	.842"	99g	Left & Right	.160", .160"	.750"	1.91"	98852LR-2
Roller Lifter Pair – For Enlarged Lifter Bores (.875")	.875"	102g	Both Centered	0	.785"	1.93"	98851C-2
Roller Lifter Pair – One Centered & One Offset Left - For Enlarged Lifter Bores (.875")	.875"	102g	Centered & Left	0, .160"	.785"	1.93"	98851CL-2
Roller Lifter Pair – One Centered & One Offset Right - For Enlarged Lifter Bores (.875")	.875"	102g	Centered & Right	0, .160"	.785"	1.93"	98851CR-2
Roller Lifter Pair – One Offset Left & One Offset Right - For Enlarged Lifter Bores (.875")	.875"	102g	Left & Right	.160", .160"	.785"	1.93"	98851LR-2
Roller Lifter Pair – Both Centered – For Enlarged Lifter Bores (.904")	.904"	102g	Both Centered	0	.820"	1.95"	98850C-2
Roller Lifter Pair – One Centered & One Offset Left – For Enlarged Lifter Bores (.904")	.904"	102g	Centered & Left	0, .180"	.820"	1.95"	98850CL-2
Roller Lifter Pair – One Centered & One Offset Right – For Enlarged Lifter Bores (.904")	.904"	102g	Centered & Right	0, .180"	.820"	1.95"	98850CR-2
Roller Lifter Pair – One Offset Left & One Offset Right – For Enlarged Lifter Bores (.904")	.904"	102g	Left & Right	.180", .180"	.820"	1.95"	98850LR-2
LS SERIES, GM GEN III/IV *LIFTER BORE SPACING MIN. 1.700" & MAX. @ .450" LIFT IS 1.975"/@.500" LIFT IS 1.950"							
Roller Lifter Pair – Both Centered	.842"	99g	Both Centered	0	.750"	2.22"	98956C-2
CHRYSLER V8 383-440 *LIFTER BORE SPACING MIN. 1.840" & MAX. @ .450" LIFT IS 2.120"/@.500" LIFT IS 2.000"							
Roller Lifter Pair – Both Centered	.904"	102g	Both Centered	0	.820"	1.95"	98829C-2
Roller Lifter Pair – One Centered & One Offset Left	.904"	102g	Centered & Left	0, .180"	.820"	1.95"	98829CL-2
Roller Lifter Pair – One Centered & One Offset Right	.904"	102g	Centered & Right	0, .180"	.820"	1.95"	98829CR-2

*The notes list the minimum allowable lifter bore spacing for each of the given Elite Race™ link bars, along with the maximum allowable spacing for .450" & .550" lift lobe applications. With internal oiling, the Elite Race™ design can be used in many non-listed applications, and this spacing information can be used to select the correct configuration.

ELITE RACE™ INDIVIDUAL PAIRS W/ CAPTURED LINK BAR (continued)

DESCRIPTION	DIAMETER	WEIGHT	PUSHROD SEAT LOCATION	OFFSET DISTANCE	WHEEL DIAMETER	SEAT HEIGHT	PART #
FORD V8 289-351W *LIFTER BORE SPACING MIN. 1.700" & MAX. @ .450" LIFT IS 1.975"/@.500" LIFT IS 1.950"							
Roller Lifter Pair – Both Centered	.875"	102g	Both Centered	0	.785"	1.93"	98838C-2
Roller Lifter Pair – One Centered & One Offset Left	.875"	102g	Centered & Left	0, .160"	.785"	1.93"	98838CL-2
Roller Lifter Pair – One Centered & One Offset Right	.875"	102g	Centered & Right	0, .160"	.785"	1.93"	98838CR-2
Roller Lifter Pair – Both Centered – For Enlarged Lifter Bores (.904")	.904"	102g	Both Centered	0	.820"	1.95"	98835C-2
Roller Lifter Pair – One Centered & One Offset Left – For Enlarged Lifter Bores (.904")	.904"	102g	Centered & Left	0, .180"	.820"	1.95"	98835CL-2
Roller Lifter Pair – One Centered & One Offset Right – For Enlarged Lifter Bores (.904")	.904"	102g	Centered & Right	0, .180"	.820"	1.95"	98835CR-2
FORD V8 352-428 & 429-460 *LIFTER BORE SPACING MIN. 1.840" & MAX. @ .450" LIFT IS 2.120"/@.500" LIFT IS 2.000"							
Roller Lifter Pair – Both Centered	.875"	102g	Both Centered	0	.785"	1.93"	98836C-2
Roller Lifter Pair – One Centered & One Offset Left	.875"	102g	Centered & Left	0, .160"	.785"	1.93"	98836CL-2
Roller Lifter Pair – One Centered & One Offset Right	.875"	102g	Centered & Right	0, .160"	.785"	1.93"	98836CR-2
Roller Lifter Pair – Both Centered - For Enlarged Lifter Bores (.904")	.904"	102g	Both Centered	0	.820"	1.95"	98839C-2
Roller Lifter Pair – One Centered & One Offset Left - For Enlarged Lifter Bores (.904")	.904"	102g	Centered & Left	0, .180"	.820"	1.95"	98839CL-2
Roller Lifter Pair – One Centered & One Offset Right - For Enlarged Lifter Bores (.904")	.904"	102g	Centered & Right	0, .180"	.820"	1.95"	98839CR-2

*The notes list the minimum allowable lifter bore spacing for each of the given Elite Race™ link bars, along with the maximum allowable spacing for .450" & .550" lift lobe applications. With internal oiling, the Elite Race™ design can be used in many non-listed applications, and this spacing information can be used to select the correct configuration.

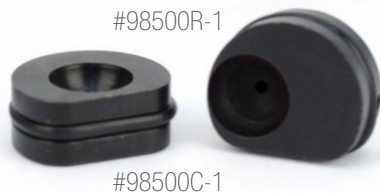

PUSHROD SEAT INSERTS

With the Elite Race™ Lifters, it is possible to remove the pushrod seat inserts and swap them out. Offered in centered, left offset and right offset options for each diameter lifter, the pushrod seats can be switched out and any combination of seats can be used. With our Pushrod Seat Insert Removal Tool, this is a simple process that allows the user to easily adjust the pushrod angle for clearance if necessary.

DESCRIPTION	DIAMETER	PUSHROD SEAT LOCATION	PART #
Centered Pushrod Seat Insert	.842"/.875"	Centered	98500C-1
Left Offset Pushrod Seat Insert	.842"/.875"	.160" Left	98500L-1
Right Offset Pushrod Seat Insert	.842"/.875"	.160" Right	98500R-1
Centered Pushrod Seat Insert	.904"	Centered	98600C-1
Left Offset Pushrod Seat Insert	.904"	.180" Left	98600L-1
Right Offset Pushrod Seat Insert	.904"	.180" Right	98600R-1
O-Ring	.842"/.875"	N/A	98501-1
O-Ring	.904"	N/A	98601-1
Pushrod Seat Insert Removal Tool	N/A	N/A	5350



PUSHROD LENGTH & ROCKER ARM GEOMETRY

A large number of variables are involved in determining the correct length pushrod for your application. Pushrod length is affected by any of the following:

- Block deck height
- Head deck height
- Head stud boss height
- Rocker arm brand/design
- Cam base circle size
- Lifter design/brand/pushrod seat height
- Valve stem length

Don't assume anything when determining the right pushrod for your new engine. A pushrod that fits one engine may not necessarily work in another. Any number of items can vary from engine to engine, requiring you to use a different pushrod length. Following the steps below will streamline the pushrod selection process, ensuring that you get the right parts the first time.

- 1. BUY A CHECKING PUSHROD.** Invest in a checking pushrod at this time. They are available in two different designs on page 255 of this master catalog. With a checking pushrod, you can actually rotate the engine over and check the rocker arm/valve tip relationship as you adjust the pushrod length. When you get the correct geometry, it is then a simple matter to measure the length and place an order.
- 2. DETERMINE CORRECT VALVE TRAIN GEOMETRY.** What is the correct length pushrod for your application? The one that produces correct valve train geometry. What is correct valve train geometry? When the rocker arm roller tip rolls from the intake side of the valve tip, across the center of the tip (at approximately mid-lift), to the exhaust side of the valve tip (at full lift) and back. See Diagram A.
- 3. MEASURE THE RESULTING PUSHROD.** Measuring the length of a pushrod is a simple process. The most important thing to remember is that different manufacturers measure pushrods differently. Not all pushrods of a stated length will measure exactly the same. The three most common pushrod measurements are shown in Diagram B.

THEORETICAL LENGTH: This assumes that the pushrod has no oil hole in the end of it. Therefore, the radius at either end is complete, which lengthens the pushrod approximately .017" in the case of a 5/16" pushrod with .100" diameter oil holes, minimally chamfered.

ACTUAL LENGTH: This is what you would measure if you had a set of calipers large enough to measure over the oil holes at each end of the pushrod. This is the measurement that most people can relate to. Unfortunately, this measurement is affected not only by the diameter of the oil holes but also by the entrance chamfer for each oil hole.

GAUGE LENGTH: Although the most difficult to measure (it requires a special length checking gauge), this measurement is the most reliable. This is because the oil holes and their chamfers are eliminated from the measurement. The only problem is that not all companies use the same gauge diameter. COMP Cams® uses a .140" gauge diameter. All Magnum and Hi-Tech™ Pushrods listed in this catalog are measured using this technique. See Diagram B.



THE GOAL IS TO MINIMIZE & CENTER THE ROLLER TIP'S SWEEP ACROSS THE VALVE

DIAGRAM A

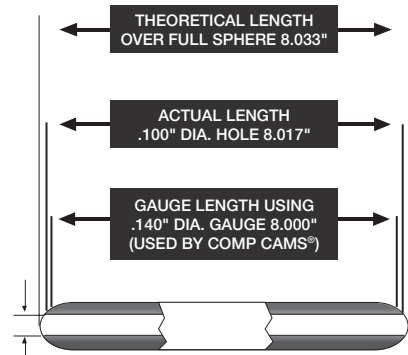

COMMON PUSHROD MEASUREMENTS

DIAGRAM B

MAGNUM CHECKING PUSHRODS

These tools make it easy and economical to lay out and determine proper pushrod length during a high performance engine rebuild. This is necessary for correct valve train geometry to obtain the desired results from the cam and to ensure damage is not done to the rest of the valve train. They are made from a thin wall 5/16" pushrod that is cut and threaded with over 1" travel and feature a 5/16" ball on each end.

DESCRIPTION	ADJUSTABLE		PART #
	FROM	TO	
Individual Length Checker	6.125"	7.500"	7905-1
Individual Length Checker	7.500"	8.700"	7901-1
Individual Length Checker	8.500"	9.800"	7902-1
Individual Length Checker	9.700"	11.000"	7903-1
Individual Length Checker	10.200"	11.500"	7904-1
Master Pushrod Checking Kit – Contains 1 Each: #7905, #7901, #7902, #7903 & #7904	6.125"	11.500"	7900



COMPONENTS PUSHRODS

HI-TECH™ CHECKING PUSHRODS

The COMP Cams® Hi-Tech™ Pushrod Length Checking Tools are precision-crafted from steel alloy and black oxidized to provide years of accurate measurements. The unique design is easy to read and eliminates the need for expensive calipers. Each complete revolution is equal to .050". Having the correct length pushrods in your engine is a critical factor in proper rocker arm geometry, and this is the best tool to measure pushrod length.

DESCRIPTION	ADJUSTABLE		PART #
	FROM	TO	
Individual Length Checker	5.800"	6.800"	7701-1
Individual Length Checker	6.800"	7.800"	7702-1
Individual Length Checker	7.800"	8.800"	7703-1
Individual Length Checker	8.800"	9.800"	7704-1
Individual Length Checker	9.800"	10.800"	7706-1
Individual Length Checker	10.800"	11.800"	7707-1
Individual Length Checker	11.800"	12.800"	7708-1
Length Checker w/ 5/16" Cup End	6.800"	7.800"	7709-1
Length Checker w/ 5/16" Cup End	7.800"	8.800"	7711-1
Length Checker w/ 5/16" Cup End	8.800"	9.800"	7719-1
Length Checker w/ 5/16" Cup End	9.800"	10.800"	7710-1
Length Checker w/ 5/16" Cup End	10.800"	11.800"	7712-1
Master Pushrod Checking Kit – Contains 1 Each: #7701, #7702, #7703 & #7704	5.800"	9.800"	7705



TECH TIP

We realize that most people don't have access to the special gauge required for the pushrod measurement techniques listed on the previous pages or even a dial caliper large enough for most pushrods. We've developed two techniques to help you determine exact pushrod length so that the perfect valve train geometry is achieved in your engine. Read about these techniques on the COMP Cams® website at http://bit.ly/valvetrain_geo.

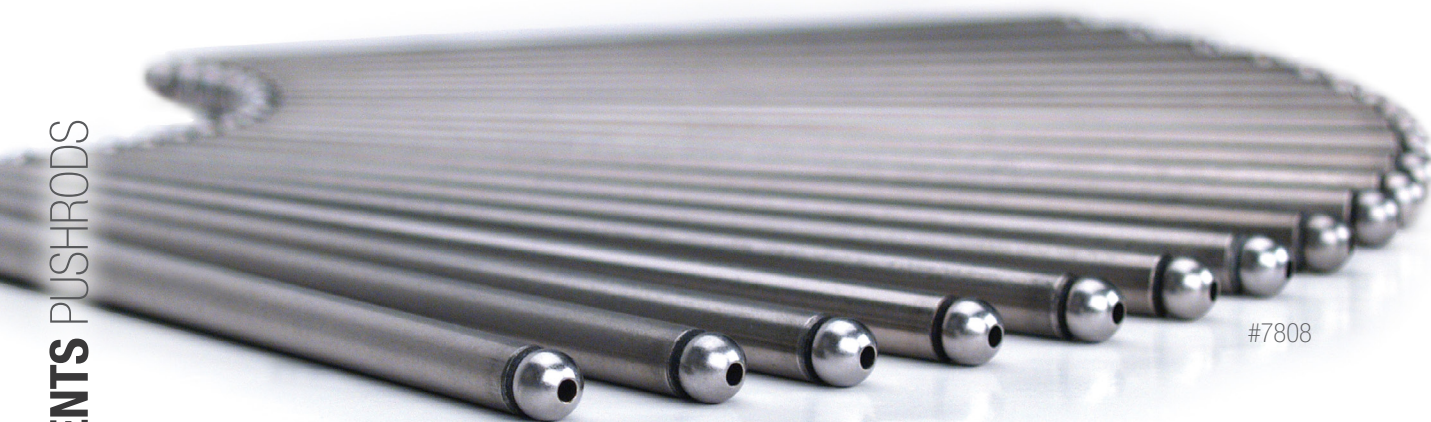

#7808

HIGH ENERGY PUSHRODS™

- Best choice when building street rods, RVs or daily driver engines
- Available in 3/8" or 5/16" diameters
- Meet or exceed all OE pushrod specifications
- Mate perfectly with High Energy™ or Magnum Rockers

MAKE	DESCRIPTION	USE WITH GUIDE PLATES	DIAMETER	ACTUAL LENGTH	END TYPE	PART #
AMC	V8 290-401, Most 1970-Up	Yes	5/16"	7.794"	H-H	7812-16
Buick	V8 350, 1968-69	No	5/16"	9.668"	H-H	7892-16
	V8 350, 1970-81	No	5/16"	9.677"	H-H	7861-16
	V8 455, 1970-76	No	5/16"	9.378"	H-H	7896-16
	V6 All, 1962-85	No	5/16"	8.684"	H-H	7869-12
Chevrolet	4 Cyl. 151, 1977-78	No	5/16"	9.677"	H-H	7861-8
	4 Cyl. 153. 1962-70 & Marine	No	5/16"	9.677"	H-H	7861-8
	6 Cyl. 194-250, 1962-84	No	5/16"	9.677"	H-H	7861-12
	V6 173 (60°), 1980-86	Yes	5/16"	6.165"	H-H	7816-12
	V6 200-262, 1978-86, Hardened Replacement	Yes	5/16"	7.794"	H-H	7812-12
	V8 262-400 w/ OE Hydraulic Roller Cam 1987-Present	Yes	5/16"	7.205"	H-H	7808-16
	V8 262-400 w/ Retro-Fit Hydraulic Roller Cam 1955-Present	Yes	5/16"	7.266"	H-H	7809-16
	V8 262-400, 1955-Present w/ Flat Tappet	Yes	5/16"	7.794"	H-H	7812-16
	V8 396-454 Intake w/ Retro-Fit Hydraulic Roller Cam 1965-Present	Yes	3/8"	7.725"	H-H	7813-8
	V8 396-454 Exhaust w/ Retro-Fit Hydraulic Roller Cam 1965-Present	Yes	3/8"	8.684"	H-H	7814-8
	V8 396-454 Retro-Fit Pushrod Set, Intake & Exhaust 1965-Present (8) #7813 Intake (8) #7814 Exhaust	Yes	3/8"	7.725" Int 8.684" Ex	H-H	7815-16
	V8 396-454, Intake, Hardened Replacement	Yes	3/8"	8.280"	H-H	7811-8
	V8 396-454, Exhaust, Hardened Replacement	Yes	3/8"	9.252"	H-H	7881-8
	V8 396-454, 1965-86 (8) #7811 Intake & (8) #7881 Exhaust (Standard Length, Standard Block)	Yes	3/8"	8.280" Int 9.252" Ex	H-H	7854-16
Chrysler	6 Cyl. 198-225, 1960-80 w/ Mechanical Cam	No	5/16"	9.954"	A-B	7864-12
	V8 273-360, 1964-86	No	5/16"	7.500"	B-B	7820-16
	V8 273-360, 1964-86 Hyd. Cam w/ Adjustable Rockers	No	5/16"	7.389"	A-B	7821-16
	V8 273-360, 1964-86 Solid w/ Adjustable Rockers	No	5/16"	7.497"	A-B	7822-16
	V8 383-400, 1968-78 w/ Non-Adjustable Rockers	No	5/16"	8.575"	B-B	7883-16
	V8 440, 1968-78 w/ Non-Adjustable Rockers	No	5/16"	9.315"	B-B	7840-16

MAKE	DESCRIPTION	USE WITH GUIDE PLATES	DIAMETER	ACTUAL LENGTH	END TYPE	PART #
Ford	6 Cyl. 170-200, 1965-83	No	5/16"	8.350"	I-I	7865-12
	6 Cyl. 240-300, 1965-84	No	5/16"	10.136"	H-H	7866-12
	V6 171 (2800cc), 1974-86	No	5/16"	5.429"	A-B	7836-12
	V8 255 & 302, 1965-Present w/ Flat Tappet	Yes	5/16"	6.881"	H-H	7831-16
	V8 302 w/ OEM Hydraulic Roller Cam 1985-Present	Yes	5/16"	6.248"	H-H	7826-16
	V8 255-302 .060" Short, 1968-85	No	5/16"	6.821"	H-H	7827-16
	V8 255-302 .060" Long, 1968-85	No	5/16"	6.936"	H-H	7828-16
	V8 302 Retro-Fit Hydraulic Roller	Yes	5/16"	6.400"	H-H	7819-16
	V8 351W, 1969-78	No	5/16"	8.152"	H-H	7835-16
	V8 351W .060" Short, 1969-78	No	5/16"	8.096"	H-H	7829-16
	V8 351W .060" Long, 1969-78	No	5/16"	8.212"	H-H	7830-16
	V8 351W Retro-Fit Hydraulic Roller	Yes	5/16"	7.694"	H-H	7823-16
	V8 351C & Cobra Jet, 1970-74	No	5/16"	8.412"	H-H	7832-16
	V8 351C Retro-Fit Hydraulic Roller	Yes	5/16"	7.870"	H-H	7825-16
	V8 351M & 400M, 1971-79	No	5/16"	9.500"	H-H	7837-16
	V8 351M & 400M .060" Short, 1971-79	No	5/16"	9.440"	H-H	7838-16
	V8 351M & 400M .060" Long, 1971-79	No	5/16"	9.560"	H-H	7839-16
	V8 351M & 400M Retro-Fit Hydraulic Roller	Yes	5/16"	8.903"	H-H	7824-16
	V8 352-428, 1965-72 Factory Non-Adjustable Rockers Only	No	5/16"	9.621"	C-C	7833-16
	V8 429-460, 1972-78	No	5/16"	8.550"	H-H	7834-16
V8 429-460 .060" Short, 1972-78	Yes	5/16"	8.500"	H-H	7843-16	
V8 429-460 .060" Long, 1972-78	No	5/16"	8.616"	H-H	7844-16	
Oldsmobile	V8 260-403, 1971-79	No	5/16"	8.234"	H-H	7842-16
	V8 400-455, 1971-79	Yes	5/16"	9.748"	H-H	7845-16
	Special for 455 Rocker Kit (#1442-KIT)	Yes	5/16"	9.654"	H-H	7841-16
	Special for 350 & 403 Rocker Kit (#1441-KIT)	Yes	5/16"	8.500"	H-H	7843-16
Pontiac	V8 350-455, 1955-79	Yes	5/16"	9.146"	H-H	7851-16
	V8 326-421, 1962-67	No	5/16"	8.684"	H-H	7869-16

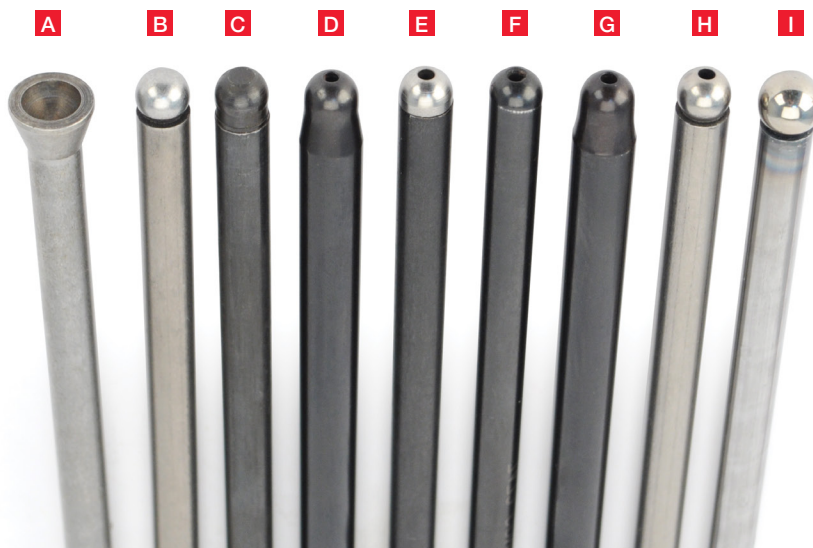

PUSHROD END TYPES

- A** 5/16" Non-Oiling Pressed-In Cup
- B** 5/16" Non-Oiling Welded Ball
- C** 5/16" Non-Oiling Pressed-In Ball
- D** One-Piece 3/8" Body With 5/16" Oil-Through Formed Tip
- E** 5/16" Oil-Through Pressed-In Ball
- F** One-Piece 5/16" Body With 5/16" Oil-Through Formed Tip
- G** 3/8" Body With 5/16" Oil-Through Pressed-In Tip
- H** 5/16" Oil Through Welded Ball
- I** 5/16" Tube 3/8" Welded Ball

All parts on this page are 50-state legal.

MAGNUM PUSHRODS *By Application*

The Magnum 5/16" and 3/8" Pushrods offer an affordable solution for your .080" wall chromemoly pushrod needs. Designed to withstand the stresses of a high performance engine, these pushrods are heat-treated for extended durability and may be ordered as single pieces or in sets of 16. Multiple end types are available to fit virtually any application.

- Durable, one-piece .080" wall chromemoly steel tubing
- Heat-treated for durability & guide plate compatibility
- Black oxide finished with laser-etched part number
- Ideal for street performance and mild race applications

MAKE	DESCRIPTION	GUIDE PLATES	DIAMETER	LENGTH	END	PART #
Chevrolet	V8 265-400 + 90° V6 200-262 w/ OEM Hydraulic Roller Cam	Yes	5/16"	7.200"	F-F	7608-16
	V8 265-400 + 90° V6 w/ Retro-Fit Hydraulic Roller Cam	Yes	5/16"	7.300"	F-F	7609-16
	V8 265-400 + 90° V6 200-262, Hardened Stock Length	Yes	5/16"	7.800"	F-F	7372-16
	V8 265-400 + 90° V6 200-262, +.100" Hardened	Yes	5/16"	7.900"	F-F	7693-16
	V8 265-400 + 90° V6 200-262, +.150" Hardened	Yes	5/16"	7.950"	F-F	7694-16
	V8 265-400 + 90° V6 200-262, +.200" Hardened	Yes	5/16"	8.000"	F-F	7695-16
	V8 265-400 + 90° V6 200-262, +.350" Hardened	Yes	5/16"	8.150"	F-F	7472-16
	V8 265-400 + 90° V6 200-262, Hardened Stock Length	Yes	3/8"	7.800"	D-D	7513-16
	V8 265-400 + 90° V6 200-262, +.100" Hardened	Yes	3/8"	7.900"	D-D	7684-16
	V8 396-454, (8) #7131 Intake (8) #7141 Exhaust (Standard Length & Block)	Yes	3/8"	8.280" Int 9.250" Ex	D-D	7154-16
	V8 396-454, Intake Stock Length (Standard Length & Block)	Yes	3/8"	8.280"	D-D	7131-8
	V8 396-454, Exhaust Stock Length (Standard Length & Block)	Yes	3/8"	9.250"	D-D	7141-8
	V8 396-454, (8) #7164 Intake (8) #7174 Exhaust (w/ Retro-Fit Hydraulic Roller Cam, Standard Block)	Yes	3/8"	7.750" Int 8.700" Ex	D-D	7663-16
	V8 366-427, (8) #7651 Intake (8) #7661 Exhaust (Truck & Marine Tall Deck Block)	Yes	3/8"	8.680" Int 9.652" Ex	D-D	7654-16
V8 366-427, Intake (Truck & Marine Tall Deck Block)	Yes	3/8"	8.680"	D-D	7651-8	
V8 366-427, Exhaust (Truck & Marine Tall Deck Block)	Yes	3/8"	9.650"	D-D	7661-8	
Chrysler	V8 273-360 w/ Non-Adjustable Rockers	No	5/16"	7.513"	C-C	7592-16
	V8 273-360 w/ Adjustable Rockers	No	5/16"	7.342"	A-C	7692-16
	V8 383-400 w/ Non-Adjustable Rockers	No	5/16"	8.555"	C-C	7402-16
	V8 383-400 w/ Adjustable Rockers	No	3/8"	8.710"	*	7422-16
	V8 440 w/ Non-Adjustable Rockers	No	5/16"	9.295"	C-C	7412-16
	V8 440 w/ Non-Adjustable Rockers	No	3/8"	9.400"	A-C	7432-16
	V8 440 w/ Adjustable Rockers	No	3/8"	9.030"	A-B	7442-16
	Special for Dodge Magnum Rocker Kit (#1425-KIT)	Yes	5/16"	6.800"	F-F	7632-16
Ford	V8 221-302, 1962-69	Yes	5/16"	6.800"	F-F	7632-16
	V8 302, 1969-85 Non-Roller, Non-H.O.	Yes	5/16"	6.900"	F-F	7631-16
	V8 Boss 302, 1969-70 Boss	Yes	5/16"	7.605"	F-F	7492-16
	V8 351W, 1969-78	Yes	5/16"	8.150"	F-F	7472-16
	V8 351C (Cobra Jet), 1970-74	Yes	5/16"	8.400"	F-F	7502-16
	V8 351C, 1970-74	Yes	3/8"	8.400"	D-D	7522-16
	V8 Boss 351C, 1971-72	Yes	3/8"	8.492"	G-G	7532-16
	V8 352-428, 1965-76 w/ Adjustable Rockers	No	11/32"	9.157"	**	7530-16
	V8 429-460, 1969-71	Yes	3/8"	8.680"	D-D	7651-16
Oldsmobile	V8 260-403, .046" Longer Than Stock	Yes	3/8"	8.280"	D-D	7131-16
	V8 400 & 455, Hardened Replacement	Yes	5/16"	9.547"	E-E	7582-16
	V8 400 & 455, +.100" Hardened	Yes	3/8"	9.647"	G-G	7664-16
Pontiac	V8 350-455, 1968-79	Yes	5/16"	9.130"	F-F	7262-16
	V8 350-455, 1968-79 w/ Solid Lifter Cam	Yes	5/16"	9.300"	F-F	7263-16

*5/16" Non-oiling cup and 3/8" non-oiling formed tip

**3/8" Non-oiling cup and 3/8" non-oiling formed tip

All parts on this page are 50-state legal.

MAGNUM PUSHRODS *By Length*

5/16" DIAMETER	
DESCRIPTION	PART #
6.200"	7620-16
6.250"	7621-16
6.300"	7622-16
6.400"	7619-16
6.750"	7623-16
6.800"	7632-16
6.850"	7633-16
6.900"	7631-16
6.950"	7634-16
7.150"	7635-16
7.200"	7608-16
7.250"	7636-16
7.300"	7609-16
7.350"	7637-16
7.400"	7638-16
7.450"	7639-16
7.500"	7640-16
7.550"	7641-16
7.600"	7492-16
7.650"	7642-16
7.700"	7643-16
7.750"	7644-16
7.800"	7372-16
7.850"	7645-16
7.900"	7693-16
7.950"	7694-16
8.000"	7695-16
8.150"	7472-16
8.250"	7646-16
8.350"	7647-16
8.400"	7502-16
8.450"	7648-16
8.500"	7649-16
8.600"	7650-16
8.900"	7652-16
9.130"	7262-16
9.200"	7653-16
9.300"	7263-16
9.450"	7655-16
9.500"	7656-16
9.547"	7582-16
9.600"	7657-16
9.650"	7658-16
9.700"	7659-16
9.750"	7660-16
9.800"	7662-16

3/8" DIAMETER	
DESCRIPTION	PART #
6.850"	7155-16
6.900"	7156-16
7.150"	7157-16
7.200"	7158-16
7.250"	7159-16
7.300"	7160-16
7.350"	7161-16
7.400"	7162-16
7.450"	7163-16
7.750"	7164-16
7.800"	7513-16
7.850"	7165-16
7.900"	7684-16
7.950"	7166-16
8.200"	7167-16
8.250"	7168-16
8.280"	7131-16
8.300"	7169-16
8.350"	7170-16
8.400"	7522-16
8.450"	7171-16
8.492"	7532-16
8.550"	7172-16
8.650"	7173-16
8.680"	7651-16
8.700"	7174-16
8.750"	7175-16
9.100"	7176-16
9.150"	7177-16
9.200"	7178-16
9.250"	7141-16
9.300"	7179-16
9.600"	7180-16
9.647"	7664-16
9.650"	7661-16
9.700"	7181-16
9.750"	7182-16
9.800"	7183-16



#7608

#7651

COMPONENTS PUSHRODS

HI-TECH™ PUSHRODS

Prior to extensive research at COMP Cams®, it was thought that the pushrod only had to be strong enough not to fail, bend or burn up at the ends. But our engineers have learned that the frequency of the pushrod must match that of all the rest of the parts in the valve train, as well as the RPM at which the engine will be run. Today's all-out race engines demand the highest quality components at every step, and COMP Cams® Hi-Tech™ Pushrods fill that requirement.

The one-piece design from .080" wall seamless chromemoly tubing ensures the ultimate in strength and durability. The ends are precision formed, yielding added thickness in the critical tip area for strength while maintaining constant wall thickness and concentricity. The pushrods are then heat-treated to ensure compatibility with guide plates and for maximum strength. They are OD-ground for consistency and black oxide finished with a length and part number laser etched on the OD for ease of identification. Hi-Tech™ Pushrods listed by length can be found on pages 262-263 while other wall thicknesses are available on pages 264-265. Hi-Tech™ Pushrods can be ordered as single units or in sets of 16.



#7972

- One-piece construction from .080" wall seamless chromemoly
- Heat-treated for extended durability & guide plate compatibility
- Precision formed and reinforced 5/16" ball type ends
- Black oxide finished and laser etched part number & length
- Ideal for serious street performance and race applications

MAKE	DESCRIPTION	WALL THICKNESS	DIAMETER	LENGTH	PART #
Small Block Chevrolet	-.600" Short Standard Length or OE Hydraulic Roller Lifter Standard Length	.080"	5/16"	7.200"	7940-16
	-.550" Short	.080"	5/16"	7.250"	7944-16
	-.500" Short Standard Length Hydraulic Roller Lifter Standard Length	.080"	5/16"	7.300"	7949-16
	-.450" Short	.080"	5/16"	7.350"	7950-16
	-.100" Short	.080"	5/16"	7.700"	7963-16
	-.050" Short	.080"	5/16"	7.750"	7970-16
	Standard Length Small Block Chevrolet	.080"	5/16"	7.800"	7972-16
	+.050" Long	.080"	5/16"	7.850"	7974-16
	+.100" Long	.080"	5/16"	7.900"	7993-16
	+.150" Long	.080"	5/16"	7.950"	7994-16
	+.200" Long	.080"	5/16"	8.000"	7995-16
	+.250" Long	.080"	5/16"	8.050"	7996-16
	+.300" Long	.080"	5/16"	8.100"	7997-16
	Standard Length Small Block Chevrolet, 3/8" Diameter	.080"	3/8"	7.800"	7913-16
+.100" Long, 3/8" Diameter	.080"	3/8"	7.900"	7984-16	
GM Gen III LS1/LS2/LS6	-.100" Short	.080"	5/16"	7.300"	7949-16
	-.075" Short	.080"	5/16"	7.325"	7794-16
	-.050" Short	.080"	5/16"	7.350"	7950-16
	-.025" Short	.080"	5/16"	7.375"	7795-16
	Standard Length GM Gen III/LS1/LS2/LS6	.080"	5/16"	7.400"	7955-16
	+.025" Long	.080"	5/16"	7.425"	7796-16
	+.050" Long	.080"	5/16"	7.450"	7956-16
	+.075" Long	.080"	5/16"	7.475"	7797-16
	+.100" Long	.080"	5/16"	7.500"	7957-16
	Standard Length GM LS7	.080"	3/8"	7.750"	8905-16
Big Block Chevrolet	Standard Length Big Block Intake	.080"	3/8"	8.280"	7931-8
	Standard Length Big Block Exhaust	.080"	3/8"	9.250"	7941-8
	Standard Length Big Block Chevrolet, Set (8) #7931 Intake & (8) #7941 Exhaust	.080"	3/8"	8.280" 9.250"	7954-16
	Standard Big Block +.100" Long Intake	.080"	3/8"	8.380"	7969-8
	Standard Big Block +.100" Long Exhaust	.080"	3/8"	9.350"	7979-8
	Standard Big Block +.100" Long, Set (8) #7969 Intake & (8) #7979 Exhaust	.080"	3/8"	8.380" 9.350"	7982-16
	Standard Big Block w/ Retro-Fit Hydraulic Roller Cam, Set (8) #8905 Intake & (8) #7907 Exhaust	.080"	3/8"	7.750" 8.700"	7998-16
	Standard Length Big Block Tall Deck Intake	.080"	3/8"	8.680"	7951-8
	Standard Length Big Block Tall Deck Exhaust	.080"	3/8"	9.650"	7961-8

HI-TECH™ PUSHRODS *continued*

COMPONENTS PUSHRODS

MAKE	DESCRIPTION	WALL THICKNESS	DIAMETER	LENGTH	PART #
Big Block Chevrolet	Standard Length Big Block Tall Deck, Set (8) #7951 Intake & (8) #7961 Exhaust	.080"	3/8"	8.680" 9.650"	7964-16
	+ .100" Long Big Block Tall Deck Intake	.080"	3/8"	8.780"	7968-8
	+ .100" Long Big Block Tall Deck Exhaust	.080"	3/8"	9.750"	7978-8
	+ .100" Long Big Block Tall Deck, Set (8) #7968 Intake & (8) #7978 Exhaust	.080"	3/8"	8.780" 9.750"	7942-16
	Standard Length Big Block Intake	.125"	7/16"	8.275"	7911-8
	Standard Length Big Block Exhaust	.125"	7/16"	9.250"	7988-8
	Standard Length Big Block, Set (8) #7911 Intake & (8) #7988 Exhaust	.125"	7/16"	8.275" 9.250"	7962-16
	Standard Length Big Block Tall Deck Intake	.125"	7/16"	8.675"	7943-8
	Standard Length Big Block Tall Deck Exhaust	.125"	7/16"	9.650"	7953-8
	Standard Length Big Block Tall Deck, Set (8) #7943 Intake & (8) #7953 Exhaust	.125"	7/16"	8.675" 9.650"	7952-16
Small Block Chrysler (Non-Adjustable Rockers)	-.050" Short Chrysler "A" 273-360	.080"	5/16"	7.450"	7956-16
	Standard Length Chrysler "A" 273-360	.080"	5/16"	7.500"	7957-16
	+.050" Long Chrysler "A" 273-360	.080"	5/16"	7.550"	7958-16
Big Block Chrysler (Non-Adjustable Rockers)	Standard Length Chrysler "B" 383-400	.080"	3/8"	8.550"	7934-16
	+.050" Long Chrysler "B" 383-400	.080"	5/16"	8.600"	7977-16
	Standard Length Chrysler "RB" 413-440	.080"	3/8"	9.300"	7923-16
	+.050" Long Chrysler "RB" 413-440	.080"	3/8"	9.350"	7979-16
Big Block Chrysler (Adjustable Rockers)	Standard Length Chrysler "B" 383-400 w/ Adjustable Rocker Arms	.080"	3/8"	8.710"	7924-16¹
Chrysler 5.7L/6.1L Hemi	Standard Length 5.7L Hemi Intake	.080"	5/16"	7.850"	7974-8
	Standard Length 5.7L Hemi Exhaust	.080"	5/16"	6.600"	7769-8
	Standard Length 5.7L Hemi, Set (8) #7974-8 Intake & (8) #7769-8 Exhaust	.080"	5/16"	6.600" 7.850"	7914-16
Ford 6 Cylinder	-.050" Short Ford 6 Cyl., 1965-83 120-200	.080"	5/16"	8.300"	7971-12
	Standard Length Ford 6 Cyl., 1965-83 120-200	.080"	5/16"	8.350"	7973-12
	+.050" Long Ford 6 Cyl., 1965-83 120-200	.080"	5/16"	8.400"	7945-12
Small Block Ford	Standard Length Ford 1962-69 221-302	.080"	5/16"	6.800"	7929-16
	+.050" Long Ford 1962-69 221-302	.080"	5/16"	6.850"	7930-16
	+.100" Long Ford 1962-69 221-302	.080"	5/16"	6.900"	7933-16
	Standard Length Ford 1968-85 255 & 302	.080"	5/16"	6.850"	7930-16
	+.100" Long Ford 1968-85 255 & 302	.080"	5/16"	6.950"	7935-16
	-.050" Short Ford 1969-78 351W	.080"	5/16"	8.100"	7997-16
	Standard Length Ford 1969-78 351W	.080"	5/16"	8.150"	7965-16
	+.050" Long Ford 1969-78 351W	.080"	5/16"	8.200"	7966-16
	Standard Length Ford 1970-74 351C & Cobra Jet	.080"	5/16"	8.400"	7945-16
	+.050" Long Ford 1970-74 351C & Cobra Jet	.080"	5/16"	8.450"	7975-16
	+.100" Long Ford 1970-74 351C & Cobra Jet	.080"	5/16"	8.500"	7976-16
	Standard Length Ford 1971 and 1972 Boss 351	.080"	5/16"	8.500"	7976-16
	Standard Length Ford 1971 and 1972 Boss 351	.080"	3/8"	8.500"	7932-16
FE Ford	Standard Length Ford 1965-76 352-428 w/ Adjustable Rockers	.120"	11/32"	9.157"	7999-16²
Big Block Ford	-.050" Short Ford 1972-78 429-460	.080"	5/16"	8.500"	7976-16
	Standard Length Ford 1972-78 429-460	.080"	5/16"	8.550"	7948-16
	+.050" Long Ford 1972-78 429-460	.080"	5/16"	8.600"	7977-16
	-.100" Short Ford 1972-78 429-460	.080"	3/8"	8.450"	7992-16
	Standard Length Ford 1972-78 429-460	.080"	3/8"	8.550"	7934-16
	Standard Length Ford 1969-71 429-460	.080"	3/8"	8.680"	7951-16
	+.100" Long Ford 1969-71 429-460	.080"	3/8"	8.780"	7968-16

¹ 5/16" Non-oiling cup and 3/8" non-oiling formed tip

² 3/8" Non-oiling cup and 3/8" non-oiling formed tip

HI-TECH™ PUSHRODS *By Length*

5/16" DIAMETER					
LENGTH	PART #	LENGTH	PART #	LENGTH	PART #
6.200"	7751-16	7.425"	7796-16	8.350"	7973-16
6.250"	7917-16	7.450"	7956-16	8.375"	7730-16
6.300"	7752-16	7.475"	7797-16	8.400"	7945-16
6.350"	7753-16	7.500"	7957-16	8.425"	7731-16
6.400"	7754-16	7.550"	7958-16	8.450"	7975-16
6.450"	7766-16	7.600"	7959-16	8.500"	7976-16
6.500"	7767-16	7.650"	7960-16	8.550"	7948-16
6.550"	7768-16	7.700"	7963-16	8.600"	7977-16
6.600"	7769-16	7.750"	7970-16	8.650"	7775-16
6.650"	7770-16	7.800"	7972-16	8.700"	7776-16
6.700"	7771-16	7.850"	7974-16	8.750"	7778-16
6.750"	7772-16	7.900"	7993-16	8.800"	7779-16
6.800"	7929-16	7.950"	7994-16	8.850"	7780-16
6.850"	7930-16	8.000"	7995-16	8.900"	7781-16
6.900"	7933-16	8.025"	7746-16	8.950"	7782-16
6.950"	7935-16	8.050"	7996-16	9.000"	7783-16
7.000"	7936-16	8.075"	7747-16	9.050"	7784-16
7.050"	7937-16	8.100"	7997-16	9.100"	7785-16
7.100"	7938-16	8.125"	7748-16	9.150"	7786-16
7.150"	7939-16	8.150"	7965-16	9.200"	7787-16
7.200"	7940-16	8.175"	7749-16	9.250"	7788-16
7.250"	7944-16	8.200"	7966-16	9.300"	7789-16
7.300"	7949-16	8.225"	7750-16	9.350"	7790-16
7.325"	7794-16	8.250"	7967-16	9.400"	7791-16
7.350"	7950-16	8.275"	7773-16	9.450"	7792-16
7.375"	7795-16	8.300"	7971-16	9.500"	7793-16
7.400"	7955-16	8.325"	7774-16		

Note: For single piece use -1 suffix

HI-TECH™ 210° RADIUS PUSHRODS

- Designed for high-lift applications where pushrod and seat interference are problems at maximum lift
- Work well with rocker arms that feature cup type adjusters and applications that require more load bearing surface from the pushrod
- Same features as other Hi-Tech™ Pushrods with addition of 210° radius rather than 180° radius
- Custom lengths available by special order

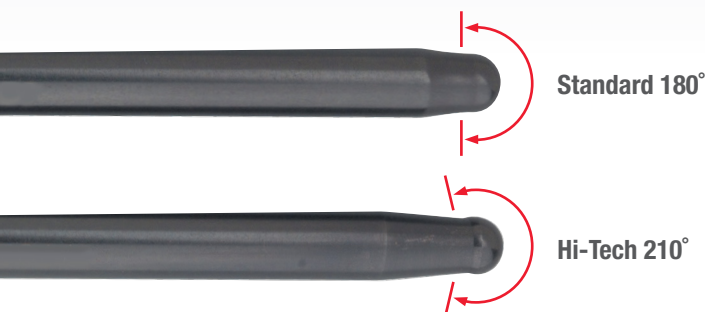

5/16" DIAMETER			
LENGTH	DIAMETER	WALL THICKNESS	PART #
7.900"	5/16"	.080"	7946-16
7.950"	5/16"	.080"	7729-16
8.000"	5/16"	.080"	7761-16
8.050"	5/16"	.080"	7947-16
8.100"	5/16"	.080"	7762-16
8.500"	5/16"	.080"	7763-16
8.550"	5/16"	.080"	7764-16
8.600"	5/16"	.080"	7765-16

3/8" DIAMETER			
LENGTH	DIAMETER	WALL THICKNESS	PART #
7.900"	3/8"	.080"	7732-16
7.950"	3/8"	.080"	7733-16
8.000"	3/8"	.080"	7734-16
8.050"	3/8"	.080"	7735-16
8.100"	3/8"	.080"	7736-16
8.500"	3/8"	.080"	7737-16
8.550"	3/8"	.080"	7738-16
8.600"	3/8"	.080"	7739-16

HI-TECH™ PUSHRODS *By Length*

3/8" DIAMETER	
LENGTH	PART #
7.500"	8900-16
7.550"	8901-16
7.600"	8902-16
7.650"	8903-16
7.700"	8904-16
7.750"	8905-16
7.800"	7913-16
7.850"	7980-16
7.900"	7984-16
7.950"	7981-16
8.000"	7983-16
8.050"	7985-16
8.100"	7986-16
8.150"	7987-16
8.175"	7740-16
8.200"	7989-16
8.225"	7741-16
8.250"	7742-16
8.280"	7931-16
8.300"	7990-16
8.325"	8700-16
8.350"	7743-16
8.380"	7969-16
8.400"	7991-16
8.425"	7745-16
8.450"	7992-16
8.500"	7932-16

LENGTH	PART #
8.550"	7934-16
8.600"	7906-16
8.650"	7912-16
8.680"	7951-16
8.700"	7907-16
8.780"	7968-16
8.800"	7908-16
8.850"	7910-16
8.900"	7927-16
8.950"	7928-16
9.000"	7918-16
9.050"	7919-16
9.100"	7920-16
9.150"	7921-16
9.200"	7922-16
9.250"	7941-16
9.300"	7923-16
9.350"	7979-16
9.400"	7755-16
9.450"	7756-16
9.500"	7757-16
9.550"	7758-16
9.600"	7759-16
9.650"	7961-16
9.700"	7760-16
9.750"	7978-16
9.800"	8701-16

LENGTH	PART #
9.850"	8702-16
9.900"	8703-16
9.950"	8704-16
10.000"	8705-16
10.050"	8706-16
10.100"	8707-16
10.150"	8708-16
10.200"	8709-16
10.250"	8710-16
10.300"	8711-16
10.350"	8712-16
10.400"	8713-16
10.450"	8714-16
10.500"	8715-16
10.550"	8716-16
10.600"	8717-16
10.650"	8718-16
10.700"	8719-16
10.750"	8733-16
10.800"	8734-16
10.850"	8735-16
10.900"	8738-16
10.950"	8739-16
11.000"	8742-16
11.050"	8743-16
11.100"	8744-16

Note: For single piece use -1 suffix

All parts on these pages are 50-state legal.

COMPONENTS PUSHRODS



STAY CONNECTED

Take your pick – Facebook, Twitter, our e-newsletter or one of our forums. You'll have insider information on new products, specials and free giveaways via our social media platforms, as well as access to our highly trained technical staff and our ever expanding library of how-to videos.

 facebook.com/COMPWins

 CPGNationTV.com

 twitter.com/COMPcams

 CPGNation.com

TECH SUPPORT OPTIONS

 **PHONE**
1.800.999.0853

 **FORUMS**
CPGNation.com

 **EMAIL & CHAT**
compcams.com

 **TWITTER**
@CPGTech

HI-TECH™ 5/16" .105" WALL PUSHRODS

- 17% stiffer than .080" wall pushrods
- Same diameter oil holes as standard wall pushrods to retain full oil flow
- Available in a variety of lengths between 6.250" and 8.200"

LENGTH	PART #
6.250"	8400-16
7.050"	8401-16
7.100"	8402-16
7.200"	8403-16
7.300"	8404-16
7.350"	8405-16
7.400"	8406-16
7.450"	8407-16
7.550"	8408-16
7.700"	8409-16

LENGTH	PART #
7.750"	8410-16
7.800"	8411-16
7.850"	8412-16
7.900"	8413-16
7.950"	8414-16
8.000"	8415-16
8.050"	8416-16
8.100"	8417-16
8.150"	8418-16
8.200"	8419-16

Note: Designed for those applications where there is limited area for larger diameter pushrods.



#8411

HI-TECH™ OIL RESTRICTING 5/16" ONE-PIECE .080" WALL PUSHRODS

COMP Cams® offers Hi-Tech™ Pushrods for four different engine platforms that restrict oil flow. While the standard Hi-Tech™ Pushrods feature .100" oil holes, the oil restricting pushrod openings are half that size at .050". These pushrods are available for Ford 302c.i. Small Block engines as well as Ford 351c.i. Windsor engines, the classic Small Block Chevy engines and GM Gen III engines. For each engine platform COMP Cams® offers five different pushrod lengths to meet any need. These pushrods maintain the consistent Hi-Tech™ Pushrod features, including one-piece 4130 chromemoly material with a wall thickness of 0.080" and 60 Rockwell hardness. To avoid confusion, each oil restricted pushrod is clearly labeled.

MAKE	DESCRIPTION	WALL THICKNESS	DIAMETER	LENGTH	PART #
Small Block Chevrolet	-.100" Short	.080"	5/16"	7.700"	8300-16
	Standard Length Small Block Chevrolet	.080"	5/16"	7.800"	8301-16
	+.100" Long	.080"	5/16"	7.900"	8302-16
	+.150" Long	.080"	5/16"	7.950"	8303-16
GM Gen III/LS1/LS2/LS6	+.200" Long	.080"	5/16"	8.000"	8304-16
	-.100" Short	.080"	5/16"	7.300"	8305-16
	-.050" Short	.080"	5/16"	7.350"	8306-16
	Standard Length Gen III/LS1/LS2/LS6	.080"	5/16"	7.400"	8307-16
	+.050" Long	.080"	5/16"	7.450"	8308-16
Small Block Ford 302	+.100" Long	.080"	5/16"	7.500"	8309-16
	-.100" Short	.080"	5/16"	6.750"	8310-16
	-.050" Short	.080"	5/16"	6.800"	8311-16
	Standard Length Small Block Ford 302	.080"	5/16"	6.850"	8312-16
Small Block Ford 351 Windsor	+.050" Long	.080"	5/16"	6.900"	8313-16
	+.100" Long	.080"	5/16"	6.950"	8314-16
	-.100" Short	.080"	5/16"	8.050"	8315-16
	-.050" Short	.080"	5/16"	8.100"	8316-16
	Standard Length Small Block Ford 351W	.080"	5/16"	8.150"	8317-16
	+.050" Long	.080"	5/16"	8.200"	8318-16
	+.100" Long	.080"	5/16"	8.250"	8319-16



HI-TECH™ 3/8" ONE-PIECE .135" WALL PUSHRODS

- 37% stiffer than .080" wall pushrods
- 210° Radius creates extra surface area at tip to allow proper seating for certain applications
- Same diameter oil holes as standard wall pushrods to retain full oil flow
- Available in a variety of lengths between 7.700" and 9.750"
- Black satin finish with laser etched part number and length



#8475



SCAN THE QR CODE

to watch a video on how to achieve proper rocker arm geometry.



LENGTH	PART #
7.700"	8479-16
7.750"	8459-16
7.800"	8460-16
7.850"	8476-16
7.900"	8473-16
7.950"	8474-16
8.000"	8475-16
8.050"	8477-16
8.100"	8478-16
8.150"	8480-16
8.200"	8481-16
8.250"	8551-16
8.280"	8461-16
8.300"	8482-16
8.350"	8483-16
8.380"	8462-16
8.400"	8484-16

LENGTH	PART #
8.450"	8485-16
8.500"	8463-16
8.550"	8464-16
8.600"	8465-16
8.650"	8486-16
8.680"	8466-16
8.700"	8467-16
8.750"	8487-16
8.780"	8468-16
8.800"	8488-16
8.850"	8489-16
8.900"	8490-16
8.950"	8491-16
9.000"	8492-16
9.050"	8493-16
9.100"	8494-16
9.150"	8495-16

LENGTH	PART #
9.200"	8547-16
9.250"	8469-16
9.300"	8548-16
9.350"	8470-16
9.400"	8549-16
9.450"	8550-16
9.500"	8543-16
9.550"	8544-16
9.600"	8545-16
9.650"	8471-16
9.700"	8546-16
9.750"	8472-16
(8) 8.280" & (8) 9.250"	8496-16
(8) 8.380" & (8) 9.350"	8497-16
(8) 8.680" & (8) 9.650"	8498-16
(8) 8.780" & (8) 9.750"	8499-16

Note: Designed for those applications where there is limited area for larger diameter pushrods.

TECH TIP

It is always a good idea to replace your pushrods when you install new rocker arms. Pushrods and rockers wear together, much like a cam and lifters. Even though the pushrods may not show any wear, installing new rockers on old pushrods can result in premature failure. Use a small amount of COMP Cams® Valve Train Assembly Spray (Part #106) on the tip of each pushrod at the rocker arm to prevent wear on initial start-up.

DUAL TAPER .125" WALL PUSHRODS

- Dual tapered 3/8" to 7/16" for strength and lightweight construction
- Constructed of special steel alloy and utilize a 210° tip for an increased load bearing surface

LENGTH	PART #
8.300"	8209-16
8.325"	8208-16
8.350"	8211-16
8.375"	8210-16
8.400"	8213-16
8.425"	8212-16
8.450"	8215-16
8.475"	8214-16
8.500"	8217-16
8.525"	8216-16
8.550"	8219-16
8.575"	8218-16
8.600"	8221-16
8.625"	8220-16
8.650"	8223-16
8.675"	8222-16
9.250"	8247-16
9.275"	8246-16

LENGTH	PART #
9.300"	8249-16
9.325"	8248-16
9.350"	8251-16
9.375"	8250-16
9.400"	8253-16
9.425"	8252-16
9.450"	8255-16
9.475"	8254-16
9.500"	8257-16
9.525"	8256-16
9.550"	8258-16
9.575"	8259-16
9.600"	8260-16
9.625"	8261-16
9.650"	8262-16

Note: For single piece use -1 suffix.

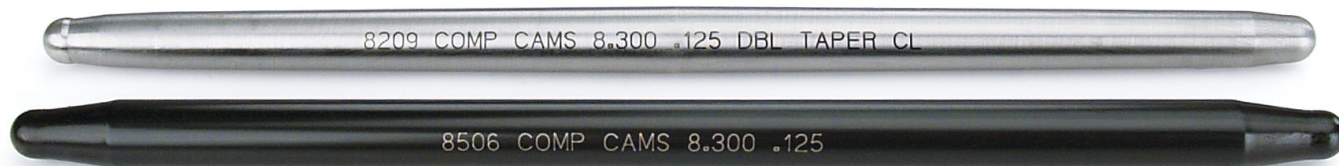

STRAIGHT TUBE 7/16" .125" WALL PUSHRODS

- Ultra-rigid large diameter design and high-strength material construction
- Avoid harmful valve train vibrations that occur when smaller diameter pushrods "snap back" into position

LENGTH	PART #
8.300"	8506-16
8.350"	8507-16
8.400"	8508-16
8.450"	8509-16
8.500"	8510-16
8.525"	8511-16
8.550"	8512-16
8.575"	8513-16
8.600"	8514-16
8.625"	8515-16
8.650"	8516-16
8.675"	7943-16

LENGTH	PART #
9.250"	7988-16
9.275"	8529-16
9.300"	8530-16
9.350"	8531-16
9.400"	8532-16
9.450"	8533-16
9.500"	8534-16
9.550"	8535-16
9.600"	8536-16
9.625"	8537-16
9.650"	7953-16

Note: For single piece use -1 suffix.

PUSHRD CLEANING BRUSH

There is a simple solution to thoroughly cleaning the internal oil passages of oiling pushrods. The COMP Cams® Pushrod Cleaning Brush is specifically designed to handle the task and built to withstand repeated use with nylon bristles and a durable steel shaft.

DESCRIPTION	PART #
Pushrod Cleaning Brush - 12" Length	7700

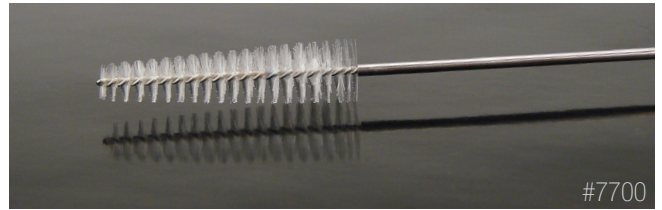

PUSHRD CUTTING BITS

These cutters are made specifically to cut pushrods and will cut up to 200 pieces. When the cut is finished, it leaves a .002" to .003" press fit between the pushrod and tip. Cutters may be ordered as needed.

Desired cutting speed is 200 RPM or less.

DESCRIPTION	PILOT	BORE	PART #
5/16" Pushrod Cutter	.157"	.169"	KD516
3/8" Pushrod Cutter	.213"	.222"	KD38
7/16" Pushrod Cutter	.184"	.284"	KD716
7/16" Tapered Pushrod Cutter	.184"	.222"	KD716T



PUSHRD ASSEMBLY TOOL

This simple tool makes assembling kits so easy that anyone can do it. After cutting your pushrod to the correct length, use this assembly tool to press the tip into place. This eliminates the risk of splitting or bending the pushrod. The tool comes with two ends for cup or ball tips.

DESCRIPTION	PART #
Pushrod Assembly Tool	4913



PUSHRD HOLDER (STABILIZER)

This tool is used to safely hold the pushrod while cutting to the desired length. The holder may be placed in a drill press for more secure and accurate cuts and also stabilizes the pushrod to control flex while cutting. The holder has a revolver that will accept 5/16", 3/8" and 7/16" pushrods. It also has a threaded hole located on top of the tool that can be used as a stop for quick, same-length cuts.

Desired cutting speed is 200 RPM or less.

DESCRIPTION	PART #
Pushrod Holder (Stabilizer)	KSTAND

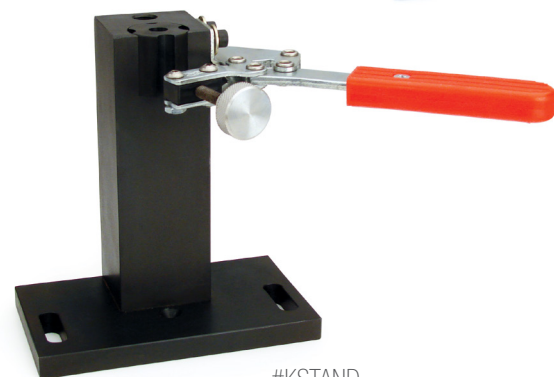

SEMI-FINISHED PUSHRODS

If you don't see the exact pushrod you need in our part number listings, check out these semi-finished pushrods for the correct length and end type you need.

You will order semi-finished pushrods in two separate pieces – 1) tubes and 2) ends.

1) Tubes



2) Ends



HOW TO ORDER SEMI-FINISHED PUSHRODS:

First, select the proper pushrod diameter.

Next, find the appropriate part # for your correct tube length and add "-16" to end of part number. This will be a quantity of 16 pushrod tubes. Select the appropriate end from the diagrams shown for the particular pushrod tube you ordered and add "-16" to part number. This will be a quantity of 16 ends. **With semi-finished pushrods, you MUST HAVE the proper pushrod cutter, which can be found on page 267 of this master catalog.**

Example: To order a 5/16" diameter pushrod that is 5.000" long with a 3/8" cup end, you would order the following part numbers:

K6805-16 (Pushrod Tubes) 3C5P-16 (Pushrod Ends) KD516 (Cutter)

END TYPES

END TYPE	PART #
5/16"	
5/16" Ball for 5/16" Shaft	TT5
5/16" Ball w/ 210° Radius for 5/16" Shaft	TT5CL
5/16" Cup for 5/16" Shaft	5C5P
3/8" Cup for 5/16" Shaft	3C5P
3/8"	
5/16" Ball for 3/8" Shaft	TT3
5/16" Ball w/ 210° Radius for 3/8" Shaft	TT3CL
3/8" Ball for 3/8" Shaft	TT4
5/16" Cup for 3/8" Shaft	5C3P
3/8" Cup for 3/8" Shaft	3C3P
7/16"	
5/16" Ball for 7/16" Shaft	TT7
5/16" Ball w/ 210° Radius for 7/16" Shaft	TT7CL
3/8" Ball for 7/16" Shaft	TT8
5/16" Cup for 7/16" Shaft	5C7P
3/8" Cup for 7/16" Shaft	3C7P
7/16" DUAL TAPER	
5/16" Ball for 3/8" Shaft	TT3 ¹
5/16" Ball w/ 210° Radius for 3/8" Shaft	TT3CL ¹
3/8" Ball for 3/8" Shaft	TT4 ¹
5/16" Cup for 3/8" Shaft	5C3P ¹
3/8" Cup for 3/8" Shaft	3C3P ¹

¹ Must use Part #KD716T for all 7/16" Dual Taper Pushrod ends

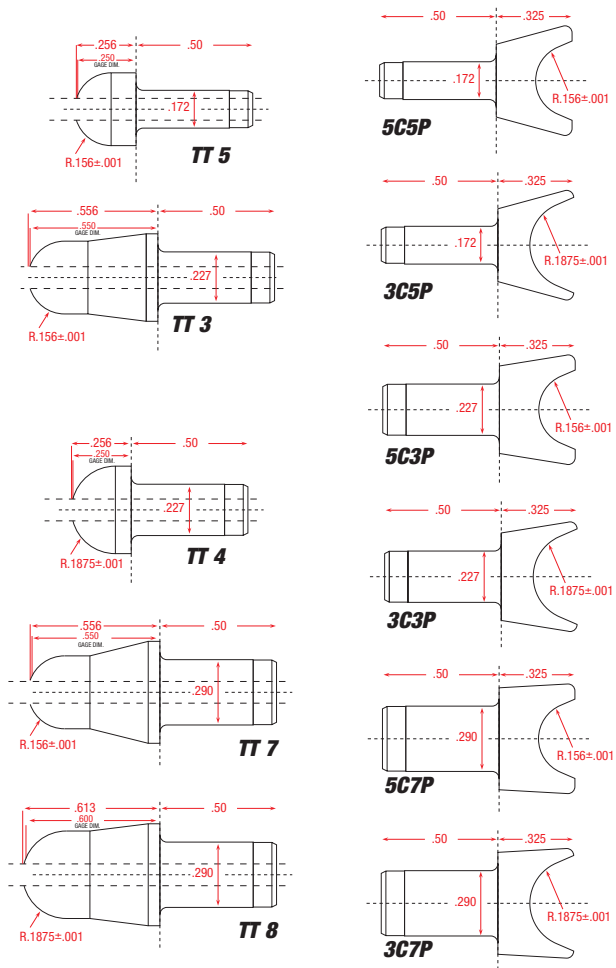

SEMI-FINISHED PUSHRODS TUBES

TUBE LENGTH	DIAMETER	WALL TYPE	WALL THICKNESS	BALL END DIAMETER	PART #
5/16"					
5.000" - 6.000"	5/16"	Hardened-Straight	.080"	5/16" Ball End	K6805
6.000" - 7.000"	5/16"	Hardened-Straight	.080"	5/16" Ball End	K7805
6.500" - 7.500"	5/16"	Hardened-Straight	.080"	5/16" Ball End	K75805
7.000" - 8.000"	5/16"	Hardened-Straight	.080"	5/16" Ball End	K8805
8.000" - 9.000"	5/16"	Hardened-Straight	.080"	5/16" Ball End	K9805
9.000" - 10.000"	5/16"	Hardened-Straight	.080"	5/16" Ball End	KK10805
10.000" - 11.000"	5/16"	Hardened-Straight	.080"	5/16" Ball End	KK11805
3/8"					
6.000" - 7.000"	3/8"	Hardened-Straight	.080"	5/16" Ball End	K7803
6.000" - 7.000"	3/8"	Hardened-Straight	.080"	3/8" Ball End	K78033
7.000" - 8.000"	3/8"	Hardened-Straight	.080"	5/16" Ball End	K8803
7.000" - 8.000"	3/8"	Hardened-Straight	.080"	3/8" Ball End	K88033
8.000" - 9.000"	3/8"	Hardened-Straight	.080"	5/16" Ball End	K9803
8.000" - 9.000"	3/8"	Hardened-Straight	.080"	3/8" Ball End	K98033
8.750" - 9.750"	3/8"	Hardened-Straight	.080"	5/16" Ball End	K975803
9.000" - 10.000"	3/8"	Hardened-Straight	.080"	5/16" Ball End	KK10803
9.000" - 10.000"	3/8"	Hardened-Straight	.080"	3/8" Ball End	KK108033
10.000" - 11.000"	3/8"	Hardened-Straight	.080"	5/16" Ball End	KK11803
10.000" - 11.000"	3/8"	Hardened-Straight	.080"	3/8" Ball End	KK118033
11.000" - 12.000"	3/8"	Hardened-Straight	.080"	5/16" Ball End	KK12803
11.000" - 12.000"	3/8"	Hardened-Straight	.080"	3/8" Ball End	KK128033
7/16"					
6.000" - 7.000"	7/16"	Hardened-Straight	.125"	5/16" Ball End	K7127
6.000" - 7.000"	7/16"	Hardened-Straight	.125"	3/8" Ball End	K71273
7.000" - 8.000"	7/16"	Hardened-Straight	.125"	5/16" Ball End	K8127
7.000" - 8.000"	7/16"	Hardened-Straight	.125"	3/8" Ball End	K81273
8.000" - 9.000"	7/16"	Hardened-Straight	.125"	5/16" Ball End	K9127
8.000" - 9.000"	7/16"	Hardened-Straight	.125"	3/8" Ball End	K91273
9.000" - 10.000"	7/16"	Hardened-Straight	.125"	5/16" Ball End	KK10127
9.000" - 10.000"	7/16"	Hardened-Straight	.125"	3/8" Ball End	KK101273
10.000" - 11.000"	7/16"	Hardened-Straight	.125"	5/16" Ball End	KK11127
10.000" - 11.000"	7/16"	Hardened-Straight	.125"	3/8" Ball End	KK111273
11.000" - 12.000"	7/16"	Hardened-Straight	.125"	5/16" Ball End	KK12127
11.000" - 12.000"	7/16"	Hardened-Straight	.125"	3/8" Ball End	KK121273
12.000" - 13.000"	7/16"	Hardened-Straight	.125"	5/16" Ball End	KK13127
12.000" - 13.000"	7/16"	Hardened-Straight	.125"	3/8" Ball End	KK131273
13.000" - 14.000"	7/16"	Hardened-Straight	.125"	5/16" Ball End	KK14127
13.000" - 14.000"	7/16"	Hardened-Straight	.125"	3/8" Ball End	KK141273
7/16" DUAL TAPER					
6.000" - 7.000"	7/16"	Hardened-Dual Taper	.125"	5/16" Ball End	K7127T
6.000" - 7.000"	7/16"	Hardened-Dual Taper	.125"	3/8" Ball End	K71273T
7.000" - 8.000"	7/16"	Hardened-Dual Taper	.125"	5/16" Ball End	K8127T
7.000" - 8.000"	7/16"	Hardened-Dual Taper	.125"	3/8" Ball End	K81273T
8.000" - 9.000"	7/16"	Hardened-Dual Taper	.125"	5/16" Ball End	K9127T
8.000" - 9.000"	7/16"	Hardened-Dual Taper	.125"	3/8" Ball End	K91273T
9.000" - 10.000"	7/16"	Hardened-Dual Taper	.125"	5/16" Ball End	KK10127T
9.000" - 10.000"	7/16"	Hardened-Dual Taper	.125"	3/8" Ball End	KK101273T
10.000" - 11.000"	7/16"	Hardened-Dual Taper	.125"	5/16" Ball End	KK11127T
10.000" - 11.000"	7/16"	Hardened-Dual Taper	.125"	3/8" Ball End	KK111273T
11.000" - 12.000"	7/16"	Hardened-Dual Taper	.125"	5/16" Ball End	KK12127T
11.000" - 12.000"	7/16"	Hardened-Dual Taper	.125"	3/8" Ball End	KK121273T
12.000" - 13.000"	7/16"	Hardened-Dual Taper	.125"	5/16" Ball End	KK13127T
12.000" - 13.000"	7/16"	Hardened-Dual Taper	.125"	3/8" Ball End	KK131273T
13.000" - 14.000"	7/16"	Hardened-Dual Taper	.125"	5/16" Ball End	KK14127T
13.000" - 14.000"	7/16"	Hardened-Dual Taper	.125"	3/8" Ball End	KK141273T



THE IMPORTANCE OF THE ROCKER ARM

One of the most important components in your engine is the rocker arm. It is also one of the most vulnerable. As the turning point of the valve train, the rocker arm is basically a sophisticated lever that redirects the upward tappet and pushrod movement and then multiplies it by the rocker ratio to downward movement at the valve. This is a highly critical process. Due to stresses and vibrations, which are more prevalent during high speed operation, rocker arms undergo what is known as deflection. Severe rocker arm deflection causes inefficient engine performance, and often results in metal fatigue leading to increased wear and friction in the valve train and eventually engine failure.

THERE ARE THREE BASIC WAYS TO INCREASE POWER THROUGH A ROCKER ARM CHANGE.

- 1. LIFT THE VALVE MORE.** By increasing the rocker arm ratio, it's possible to increase valve lift without ever touching the camshaft. Valve lift can typically be increased as much as 10% by increasing rocker ratio.
- 2. MAKE THE ROCKER ARM STIFFER.** To increase stiffness, look at three characteristics: material, geometry and the rocker's holding fixture. The easiest way to increase stiffness is to switch to chromemoly steel. Although heavier than some other materials, it can offer some design advantages and have much thinner sections than aluminum due to its superior strength density. Stiffness of the mounting is just as important as the stiffness of the rocker body. For the ultimate in high performance, shaft mounted rockers may be the way to go.
- 3. DECREASE THE MOMENT OF INERTIA.** The moment of inertia is the rocker's resistance to rotation. The higher this measurement, the more valve spring pressure it takes to control the rocker arm instead of the valves – losing RPM and horsepower. The moment of inertia is lowered by lightening the rocker arm's weight, particularly at areas that are farther from the trunnion. Two ways you can do this are by switching to a lighter weight material or by removing mass from the rocker body design.

ALUMINUM ROCKERS

Until recently, aluminum rocker arms have been considered a more affordable but less durable option to steel rockers. This is because when directly compared to steel, aluminum requires more material to handle the stress of a given force. Since more material is required and there is a limited amount of space available in the trunnion, the bearing and axle are typically smaller in an aluminum rocker arm. Previous designs weren't able to be used in extreme applications and featured decreased stiffness and increased deflection. But COMP Cams® has developed aluminum rockers that use precision-sorted needle bearing trunnions to withstand both aggressive spring pressures and valve lift. The COMP® Ultra-Gold™ ARC Aluminum Roller Rockers actually have the highest rocker-to-valve spring clearance of any aluminum rocker – up to 1.625" valve spring O.D. And while these aluminum rockers are lightweight, they are still incredibly strong and feature a lifetime warranty.

STEEL ROCKERS

COMP Cams® steel rocker arms are all constructed from 8620 or 8650 chromemoly steel, which is a higher grade material that makes them extremely durable and tough. The material keeps them from flexing, and they have large trunnions and more needle bearings, which allow the load to be more evenly spread and the rocker to last longer. Steel can thus be run in harsh environments without fatigue issues. And some COMP® steel rockers are even lighter than most aluminum because COMP® has reduced mass in low stress areas.

STUD AND SHAFT MOUNTED ROCKERS

Rocker design continues to evolve as more aggressive cam profiles and cylinder heads are developed. Stud mounted rockers have evolved over the years. Starting as a simple ball-and-socket mounted stamped steel piece, the first modification was to change the mount to a roller bearing and a transverse mounting axle. Next, larger screw-in studs were added. Soon, geometric designs had to change and stiffer material was required, giving way to the innovative arched web design as seen in today's Ultra Pro Magnum™ and Ultra Pro Magnum™ XD Rockers from COMP Cams®.

The next step in rocker arm technology is the shaft mounted rocker. Rather than being mounted on a stud, a horizontal shaft works as the fulcrum. This significantly increases the mounting stiffness and valve train stability. Shaft mounted systems are designed for high-end performance applications. A cost-effective alternative is to use a stud girdle to reduce deflection with stud mounted rockers.

HAVE QUESTIONS?
WE CAN HELP YOU

Just Call Our
Toll Free Tech Line

CAMHELP®
800.999.0853

MAGNUM ROLLER ROCKER ARMS

COMP Cams® Magnum Roller Rockers are the ultimate street rocker because they were designed with the serious performance enthusiast in mind. They will help your engine make more power and last longer.

- Ultimate street roller rocker arm designed for serious performance enthusiasts
- Constructed from 8620 chromemoly steel, a superior material that will not flex and ensures maximum lift
- Roller tip reduces friction while stiff design and superior ratio accuracy yield more effective valve lift
- For applications with less than 350 lbs. of open spring pressure



MAKE	DESCRIPTION	STUD DIA.	RATIO	PART #
AMC	V8 290-401	3/8"	1.6	1442-16 ¹
Chevrolet	V6 60° 173	10mm	1.52	1413-12
	V6 60° 173	10mm	1.6	1414-12
	V6 200-262	3/8"	1.52	*1412-12
	V6 200-262	3/8"	1.6	*1416-12 ²
	V8 265-400	3/8"	1.52	*1412-16
	V8 265-400	3/8"	1.6	*1416-16 ²
	V8 396-454	7/16"	1.72	*1411-16 ³
	V6 1988 & Later w/ Self-Aligning Rockers	3/8"	1.52	1417-12
	V6 1988 & Later w/ Self-Aligning Rockers	3/8"	1.6	1418-12
	V8 1988 & Later w/ Self-Aligning Rockers	3/8"	1.52	1417-16
	V8 1988 & Later w/ Self-Aligning Rockers	3/8"	1.6	1418-16
	Ford	V8 289-351W (Rail Type) 1968-89	3/8"	1.6
V8 289-351W (Rail Type) 1968-89		3/8"	1.7	1450-16 ⁴
V8 289-351W (Non Rail) 1961-67		3/8"	1.6	1442-16 ⁵
Boss 302, 351C-400M		7/16"	1.72	1411-16 ¹
V8 429-460		7/16"	1.72	1411-16 ¹
Oldsmobile	V8 260-455	3/8"	1.6	1442-16 ⁶
Pontiac	V8 265-455	7/16"	1.52	1451-16 ⁷
	V8 265-455	7/16"	1.65	1452-16 ⁷

Note: Rockers available as singles, half sets and full sets.

¹ Must have screw-in studs and guide plates

² May require machine work to the cylinder head

³ Use stud #4514-16 to replace late model pedestal

⁴ For 1978-present with Part #4504-16 studs, not for use with guide plates

⁵ Also can be used on heads with guide plates

⁶ See p.280 for the kit of necessary components that go with this part

⁷ Includes 7/16" balls, 3/8" and 7/16" nuts

*50-State legal for 1993 and older GM vehicles equipped with 200 c.i.d. (4.2L) to 454 c.i.d. (7.4L) gasoline engines. C.A.R.B. E.O. #D-279-4.

TECH TIP

Never install rockers dry. They must be lubricated during initial start-up with the proper lubricant to avoid permanent damage. A generous amount of COMP Cams® Valve Train Assembly Spray (Part #106) on each rocker arm, pivot ball, bushing pushrod tip and valve tip can prevent damage to new parts. The COMP Cams® special Valve Train Assembly Spray is the protection you need against premature wear.

ULTRA PRO MAGNUM™ ROLLER ROCKER ARMS

The Ultra Pro Magnum™ Roller Rocker Arms not only live up to the lofty standards of the original Pro Magnum™ Rockers, but they also take stud mount rocker performance, stability and value to a whole new level. The modern arched, web-like design delivers increased strength and rigidity while still reducing the moment of inertia and optimizing the dynamic balance.

- Investment cast 8650 chromemoly body and arched, web-like design deliver increased strength and rigidity while reducing moment of inertia
- Withstand valve spring pressures up to 850 lbs.
- Unique black oxide exterior finish helps prevent corrosion, thus increasing durability
- Increased retainer and valve spring clearances allow use of large diameter springs, retainers and +.050" locks without clearance or fitment issues
- Feature oversized trunnions, precision-sorted needle bearings and hardened roller tips

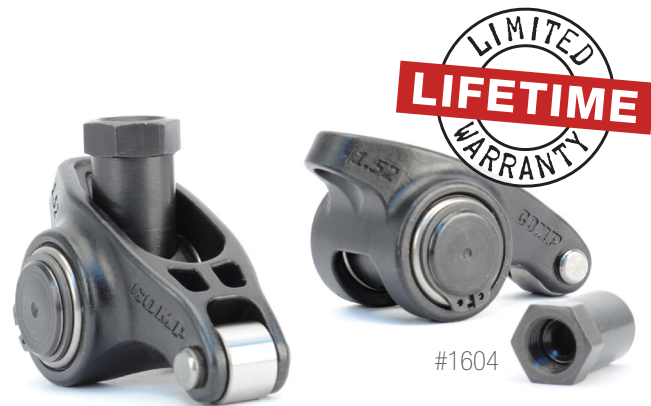

LIMITED LIFETIME WARRANTY:

Ultra Pro Magnum™ Rocker Arms are so strong that we warranty the rocker bodies against breakage for life.

MAKE	DESCRIPTION	STUD DIA.	RATIO	PART #
Chevrolet	V6 200-262	3/8"	1.52	1601-12
	V6 200-262	3/8"	1.6	1602-12
	V6 200-262	7/16"	1.52	1604-12
	V6 200-262	7/16"	1.6	1605-12
	V8 265-400	3/8"	1.52	1601-16
	V8 265-400	3/8"	1.6	1602-16
	V8 265-400	7/16"	1.52	1604-16
	V8 265-400	7/16"	1.6	1605-16
	V8 265-400 Twisted Wedge Head, Intake Valve	3/8"	1.52	1607-8
	V8 265-400 Twisted Wedge Head, Intake Valve	3/8"	1.6	1609-8
	V8 265-400 Twisted Wedge Head, Intake Valve	7/16"	1.52	1608-8
	V8 265-400 Twisted Wedge Head, Intake Valve	7/16"	1.6	1610-8
	V6 1988 & Later w/ Self Aligning Rockers	3/8"	1.52	1617-12
	V6 1988 & Later w/ Self Aligning Rockers	3/8"	1.6	1618-12
	V8 1988 & Later w/ Self Aligning Rockers	3/8"	1.52	1617-16
	V8 1988 & Later w/ Self Aligning Rockers	3/8"	1.6	1618-16
	V8 348-409	3/8"	1.7	1629-16
	V8 396-454	7/16"	1.7	1620-16
V8 396-454	1/2"	1.7	1625-16	
GM LS	LS1/LS2/LS6	3/8"	1.8	1675-16
	LS1/LS2/LS6	Pedestal Mount	1.8	1677-16
	LS3 (Factory Offset)	3/8"	1.8	1676-16
	LS3 (Factory Offset)	Pedestal Mount	1.8	1678-16
Ford	V6 3.8L	3/8"	1.7	1619-12
	V8 289-302-351W	3/8"	1.6	1631-16
	V8 289-302-351W	7/16"	1.6	1632-16
	V8 Boss 302, 351C, 429-460	7/16"	1.7	1630-16
	V8 Self Aligning Rockers	3/8"	1.6	1634-16
SHAFT MOUNT (ALSO SEE P. 274)				
Chrysler	V8 273-360	Shaft	1.5	1622-16 ¹
	V8 383-440	Shaft	1.5	1621-16 ¹
	Shafts for #1621 Rockers	—	—	1077-2
	Shafts for #1622 Rockers	—	—	1079-2

¹ Requires a ball/ball pushrod

TECH TIP

Rebuildable! These heavy-duty rocker arms can be rebuilt. We will disassemble and inspect them, then replace the roller tips, axles, trunnions and bearings to make your rocker arms like new.

ULTRA PRO MAGNUM™ XD ROLLER ROCKER ARMS

Built to outlast and outperform in accuracy and strength, the Ultra Pro Magnum™ XD Rocker Arms are engineered from durable 8650 steel and include a machined billet pushrod seat insert for a wide range of super accurate ratios. A unique and wide ratio range to fit almost any popular application from 1.5 to 1.8 in .5" increments for Chevy and 1.6 to 1.73 for various Ford applications is available. These XD rockers are fully rebuildable and boast precision-sorted needle bearings and hardened roller tips. And, they work with most diameter springs and retainers. The XD design utilizes advanced FEA and CAD design and development to improve strength, stiffness and MOI (moment of inertia) optimization for drag and circle track applications.

- Machined billet pushrod seat insert for wide range of rocker ratios used in popular Chevy and Ford applications
- 8650 Steel construction outlasts and outperforms other rockers in accuracy and strength
- For applications with up to 1000 lbs. open spring pressure
- Precision-sorted needle bearings and hardened roller tips better distribute the load and reduce wear
- Engineered for use in circle track and drag race applications



LIMITED LIFETIME WARRANTY:
Ultra Pro Magnum™ XD Rocker Arms are so strong that we warranty the rocker bodies for life against breakage.

COMPONENTS ROCKER ARMS

MAKE	DESCRIPTION	STUD DIA.	RATIO	PART #
AMC	V8 290-401	7/16"	1.6	1832-16 ¹
Chevrolet	V6 200-262	3/8"	1.5	1801-12 ¹
	V6 200-262	3/8"	1.55	1807-12 ¹
	V6 200-262	3/8"	1.6	1802-12 ¹
	V6 200-262	3/8"	1.65	1803-12 ¹
	V6 200-262	7/16"	1.5	1804-12 ¹
	V6 200-262	7/16"	1.55	1808-12 ¹
	V6 200-262	7/16"	1.6	1805-12 ¹
	V6 200-262	7/16"	1.65	1806-12 ¹
	V8 265-400	3/8"	1.5	1801-16
	V8 265-400	3/8"	1.55	1807-16 ¹
	V8 265-400	3/8"	1.6	1802-16
	V8 265-400	3/8"	1.65	1803-16
	V8 265-400	7/16"	1.5	1804-16 ¹
	V8 265-400	7/16"	1.55	1808-16 ¹
	V8 265-400	7/16"	1.6	1805-16 ¹
	V8 265-400	7/16"	1.65	1806-16 ¹
	V8 265-400	7/16"	1.7	1817-16 ¹
	V8 265-400	1/2"	1.5	1810-16 ¹
	V8 396-454	7/16"	1.6	1826-16 ¹
	V8 396-454	7/16"	1.7	1820-16 ¹
V8 396-454	7/16"	1.73	1823-16 ¹	
V8 396-454	7/16"	1.8	1828-16 ¹	
Ford	V8 Boss 302, 351C, 429-460	7/16"	1.73	1830-16 ¹
	V8 289-302-351W	3/8"	1.6	1831-16
	V8 289-302-351W	7/16"	1.6	1832-16 ¹
	V8 289-302-351W	3/8"	1.7	1833-16
	V8 289-302-351W	7/16"	1.7	1834-16 ¹

¹ Must use screw-in studs and guide plates

Note: Most popular part #'s also available in -8 suffix; for single or spares, order -1 suffix.

1/2" STUD UPGRADE KIT FOR ULTRA PRO MAGNUM™/XD ROCKER ARMS

- Converts Ultra Pro Magnum™ and Ultra Pro Magnum™ XD Rockers to accommodate 1/2" rocker studs
- Increases stability and stiffness
- For extreme duty and race applications
- NHRA approved

COMPONENTS	PART #
Includes (16) each: Trunnions, Bearings, Snap Rings, Polylocks & Studs	13706-KIT



#1622

**ULTRA PRO MAGNUM™
CHRYSLER SHAFT MOUNT ROCKER SYSTEMS**

- Made from SAE 8620 chromemoly steel and heat-treated for maximum strength and stiffness
- Contain proprietary bushing inserts
- Designed to handle roller lobes and higher spring rates
- Unique oil system oils all critical parts for long lasting service
- Systems include a special adjuster which allows the use of conventional ball end pushrods

DESCRIPTION	RATIO	PART #
Chrysler V8 273-360, (Spacers & Shafts Included)	1.5	1622-16
Chrysler V8 B/RB 383-440 (Complete Kit), Bolts, Shafts & Spacers Included	1.5	1621-16
Replacement Rocker Arm for #1622	1.5	1622-1
Replacement Shafts for #1622 (Pair)	—	1079-2
Replacement Rocker Arm – Left for #1621	1.5	1621L-1
Replacement Rocker Arm – Right for #1621	1.5	1621R-1
Replacement Shafts for #1621 (Pair)	—	1077-2
Bolts and Dividers for #1621-16	—	1321H-1
Replacement Spacer (1 Each – Requires 8)	—	CR40
Replacement Nut for #1621/#1622 Adjuster	—	1321N-1
Replacement Adjusting Screw for #1621/#1622	—	1321S-1



#16755-KIT



**GM LS ULTRA PRO MAGNUM™
ROCKER ARM KITS**

COMP Cams® offers GM Gen III LS1/LS6 and Gen IV LS3 Ultra Pro Magnum™ Rocker Arm Kits, both of which include rocker arms, guide plates (5/16" or 3/8"), rocker studs, adjusting nuts and set screws. Designed to fit under the stock valve covers without machining, COMP® GM LS Ultra Pro Magnum™ Rocker Arm Upgrade Kits are the simple solution upgrading the valve train components in your GM Gen III/IV engine.

All components listed are available separately and in sets. COMP Cams® Rocker Upgrade Kits do NOT include pushrods, but they are available separately; see pushrod lengths in the application chart.

COMPONENTS	RATIO	COMPONENT PART #	PART #
LS1/LS6			
1.8:1 Ultra Pro Magnum™ Rocker Arm Set	1.8	1675-16	16755-KIT
5/16" Flat Guide Plates for 5/16" Pushrods		4854-8	
3/8" Rocker Studs		4554-16	
3/8" Adjusting Nut		4654-16	
Set Screw for #4654		4654SS-16	
LS3			
1.8:1 Ultra Pro Magnum™ Rocker Arm Set	1.8	1676-16	16765-KIT
5/16" Guide Plates for 5/16" Pushrods		4855-8	
3/8" Rocker Studs		4554-16	
3/8" Adjusting Nut		4654-16	
Set Screw for #4654		4654SS-16	

OEM LS ROCKER ARM TRUNNION/ROLLER BEARING UPGRADE RETRO-FIT KIT

- Converts a stock LS series rocker arm into a captured roller trunnion for race applications
- Increases stability and stiffness
- NASCAR spec LS engine proven for race applications

COMPONENTS	COMPONENT PART #	PART #
Rocker Arm Trunnion	137021	13702-KIT
Rocker Arm Bearing	137022	
Rocker Arm Retaining Ring	137023	





#1212

MAKE	DESCRIPTION	STUD DIA.	RATIO	PART #
AMC	1974-79	Pedestal	1.6	1210-16
Chevrolet	6 Cyl. 173-207, 1980-95	3/8"	1.5	1216-12¹
	6 Cyl. 194-292, 1962-84	3/8"	1.75	1261-12
	V8 265-400, V6 200-262	3/8"	1.5	1212-16²
	396-454, 1965-87	7/16"	1.7	1211-16³
Chrysler	2.2, 1981-87	OHC	—	1222-8
Ford	2300cc 4 Cyl.	OHC	—	1270-8
	6 Cyl. 240-300, 1967-78	3/8"	1.6	1266-12
	V8 289-351W, 1968-77	3/8"	1.6	1231-16⁴
	351W	Pedestal	1.6	1235-16
	351C-400M, 1970-87	Pedestal	1.73	1232-16
Oldsmobile	260-455, 1967-79	Pedestal	1.6	1242-16
	Pontiac	V8 265-455, 1967-79	3/8"	1.5
NITRIDED				
Chevrolet	V8 265-400, V6 200-262	3/8"	1.5	1217-16
	V8 265-400, V6 200-262	3/8"	1.6	1218-16
	V8 265-400	7/16"	1.5	1220-16
	396-454, 1965-87	7/16"	1.7	1219-16

¹ Will work in some 4 cyl. applications also

² Will not replace "late model" rail rocker

³ Will not replace "late model" pedestal rocker

⁴ Rail-type rocker arm

HIGH ENERGY STEEL ROCKER ARMS™

- Excellent replacement rocker arms for engine rebuilds with a stock or High Energy Camshaft™
- Help to eliminate noise and slop associated with worn or high mileage stock rockers
- Include adjusting nuts and pivot balls where required
- Feature a long slot for higher than stock lift camshafts
- Valve train deflectors recommended when using a high volume or high pressure oil pump
- Nitrided rockers are designed for higher valve spring pressures and hardened pushrods
- Nitriding increases hardness, thus improving durability and longevity of rocker arms

COMPONENTS ROCKER ARMS



#17044

HIGH ENERGY™ DIE CAST ALUMINUM ROLLER ROCKER ARMS

The COMP Cams® High Energy™ Aluminum Roller Rocker Arms are designed for street and moderate race use and feature a die-cast body created from aluminum with a needle bearing fulcrum and roller tip. The die-cast, larger than stock body offers the strength properties and light weight of aluminum while the specially engineered fulcrum and roller tip decrease friction and lower oil temperatures, thus improving response and horsepower.

- Affordable aluminum rocker option
- Strength properties and light weight of aluminum
- Needle bearing fulcrum and roller tip reduce friction and lower oil temps for improved response and HP

¹ Must use screw-in studs and guide plates

² Will not replace "late model" rail rocker

³ May require machine work to the cylinder head

⁴ Requires Part #4514-16 to replace "late model" pedestal rocker

MAKE	DESCRIPTION	STUD DIA.	RATIO	PART #
AMC	V8 290-401	7/16"	1.6	17044-16¹
Chevrolet	V8 265-400	3/8"	1.5	17001-16²
	V8 265-400	3/8"	1.6	17002-16^{2,3}
	V8 265-400	7/16"	1.5	17004-16^{1,2}
	V8 265-400	7/16"	1.6	17005-16^{1,2}
	V8 396-454	7/16"	1.7	17021-16⁴
Ford	V8 289, 302-351W	3/8"	1.6	17043-16¹
	V8 289, 302-351W	7/16"	1.6	17044-16¹
	V8 Boss 302, 351C, 429-460	7/16"	1.73	17045-16¹
Oldsmobile	V8 260-455	7/16"	1.6	17044-16¹



ULTRA-GOLD™ ARC ALUMINUM ROLLER ROCKER ARMS

The original Ultra-Gold™ Aluminum Rockers changed the way racing and high performance street engine builders approached valve train design. Now, COMP Cams® is revolutionizing valve train performance again with the next generation of Ultra-Gold™ ARC Series Aluminum Rocker Arms, featuring an Arced, Recessed, Contoured design. Using cutting-edge design techniques and manufacturing processes, Ultra-Gold™ ARC Rockers increase engine power, enhance valve train stability and improve oiling. Ultra-Gold™ ARC Rockers feature a new extrusion based on improvements developed through FEA analysis, resulting in an even stronger, stiffer body without compromising mass. A new arced channel and contoured top, similar to a bridge design, give the rockers the best strength-to-weight ratio possible. The body has additional CNC contouring to improve clearances for valve covers and springs. Manufactured entirely in the U.S.A., all Ultra-Gold™ ARC Series Aluminum Rocker Arms feature a spring oiler channel through the body for improved lubrication. Trunnion retaining clips have been replaced with an ultra durable spiral lock type clip, similar to what holds a piston pin in place. Stress relieving radii have also been added to areas of the body, trunnion and pushrod seat insert. Even the included locking nuts (not used in LS applications) have been revised to increase surface area to better maintain lash and eliminate wear.

- Increase engine power, enhance valve train stability and improve oiling
- CNC-machined, lightweight design removes weight and yields unrivaled quality and ratio accuracy
- Arced channel & contoured top give the rockers the best strength to weight ratio possible
- Precision-sorted trunnion bearings withstand valve spring pressure up to 700 lbs.
- Designed for high performance street and race engines

Precision-sorted trunnion bearing withstands aggressive valve spring pressure & valve lift

Arced design with channel & contoured top give best strength-to-weight ratio

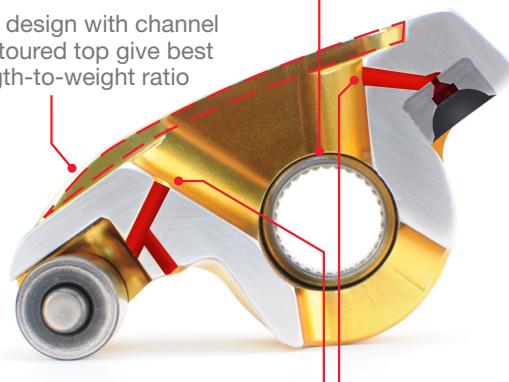

Multiple passages for valve & spring tip lubrication

LIMITED LIFETIME WARRANTY:

Ultra-Gold™ ARC Aluminum Roller Rocker Arms are so strong that we warranty the rocker bodies against breakage for life.



HAVE QUESTIONS?
WE CAN HELP YOU

Just Call Our
Toll Free Tech Line

CAMHELP®
800.999.0853

MAKE	DESCRIPTION	STUD DIA.	RATIO	PART #
AMC	V8 290-401	7/16"	1.6	19044-16^{3,4}
Chevrolet	V6 200-262	3/8"	1.5	19001-12^{1,3}
	V6 200-262	3/8"	1.6	19002-12^{1,3}
	V6 200-262	7/16"	1.5	19004-12^{1,3}
	V6 200-262	7/16"	1.6	19005-12^{1,3}
	V8 265-400	3/8"	1.5	19001-16^{1,3}
	V8 265-400	3/8"	1.6	19002-16^{1,3}
	V8 265-400	7/16"	1.5	19004-16^{1,3}
	V8 265-400	7/16"	1.6	19005-16^{1,3}
	V8 396-454	7/16"	1.7	19021-16³
GM LS	GM LS1/LS2/LS6 - Non-Adjustable	Pedestal Mount	1.72	19024-16²
	GM LS1/LS2/LS6 - Non-Adjustable	Pedestal Mount	1.82	19025-16²
	GM LS1/LS2/LS6 - Adjustable	Pedestal Mount	1.72	19026-16²
	GM LS1/LS2/LS6 - Adjustable	Pedestal Mount	1.82	19027-16²
	GM LS3/L92 - Non-Adjustable	Pedestal Mount	1.72	19028-16²
	GM LS3/L92 - Non-Adjustable	Pedestal Mount	1.82	19029-16²
	GM LS3/L92 - Adjustable	Pedestal Mount	1.72	19030-16²
	GM LS3/L92 - Adjustable	Pedestal Mount	1.82	19031-16²
Ford	V8 289-302-351W	3/8"	1.6	19043-16^{3,4}
	V8 289-302-351W	3/8"	1.72	19048-16^{3,4}
	V8 289-302-351W	7/16"	1.6	19044-16^{3,4}
	V8 289-302-351W	7/16"	1.72	19049-16^{3,4}
	V8 302-351W 1977-92	5/16"	1.6	19052-16⁶
	V8 302-351W 1977-93	5/16"	1.7	19054-16⁶
	V8 351C, 429-460	7/16"	1.73	19045-16³
Oldsmobile	V8 260-455	7/16"	1.6	19044-16^{3,4}
Pontiac	V8 265-455	7/16"	1.5	19060-16³
	V8 265-455	7/16"	1.65	19061-16³
NARROW BODY				
Chevrolet	V8 1988-Up 305-350 w/ Center Bolt Valve Covers, Narrow Body Rocker Arm w/ Self Aligning Roller Tip	3/8"	1.5	19015-16
	V8 1988-Up 305-350 w/ Center Bolt Valve Covers, Narrow Body Rocker Arm, NON Self Aligning	3/8"	1.5	19017-16
	V8 1988-Up 305-350 w/ Center Bolt Valve Covers, Narrow Body Rocker Arm w/ Self Aligning Roller Tip	3/8"	1.6	19016-16
	V8 1988-Up 305-350 w/ Center Bolt Valve Covers, Narrow Body Rocker Arm, NON Self Aligning	3/8"	1.6	19018-16
BREAK-IN ROCKER ARMS				
Chevrolet	Small Block V6 200-262, V8 265-400	7/16"	1.3	19012-16^{1,5}
REPLACEMENT PARTS				
Single Replacement Pedestal for #19024/19025/19026/19027 Rockers				4663-1
Set of Replacement Pedestals for #19024/19025/19026/19027 Rockers				4663-8
Single Replacement Pedestal for #19028/19029/19030/19031 Rockers				4662-1
Set of Replacement Pedestals for #19028/19029/19030/19031 Rockers				4662-8
Single Replacement Pedestal Bolt				4661-1
Set of Replacement Pedestal Bolts				4661-16
Single Replacement Cup Adjuster Screw				4660-1
Set of Replacement Cup Adjuster Screws				4660-16
Single Replacement 12 Pt. Cup Adjuster Nut				4658-1
Set of Replacement 12 Pt. Cup Adjuster Nuts				4658-16

¹ Will not replace late model rocker

² Includes pedestals and bolts

³ Must use screw-in studs and guide plates

⁴ Requires stud #4514-16 to replace late model pedestal

⁵ For V6 use -12 suffix

⁶ Clearance must be checked when using stock valve cover

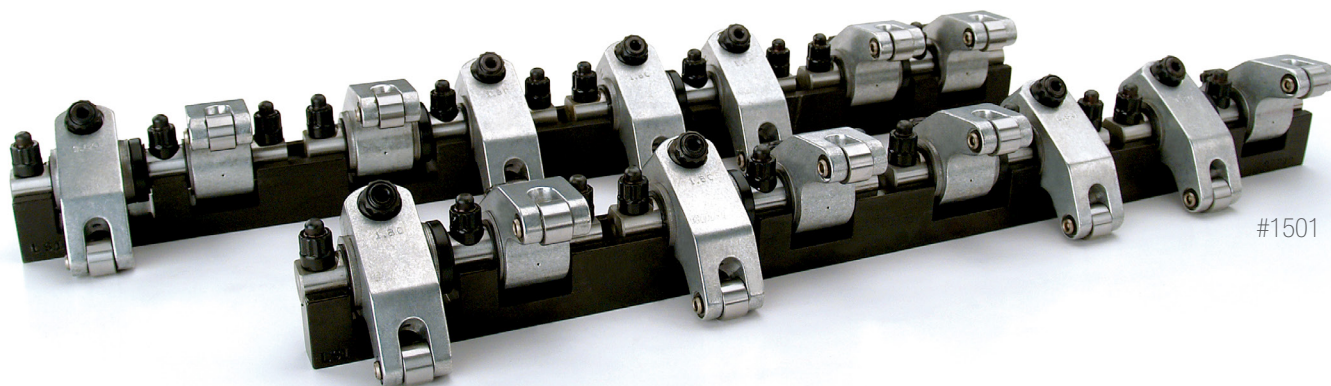

#1501

SHAFT MOUNT ALUMINUM ROCKER SYSTEMS

Using COMP® Shaft Mount Rocker Systems is one of the most effective ways to increase horsepower. These systems transfer the power of the camshaft to the valve by properly positioning the rocker over the valve. Constructed from 2024 aluminum and using an 8620 hardened steel shaft, COMP® shaft rockers are designed using the latest in computer technology and are field tested by experts in every type of racing.

- Made from 2024 aluminum and use 8620 hardened steel shaft
- Most efficient way to transfer the power of the cam to the valve
- Rigidity of the shaft system adds stability to the cylinder head and the valve train
- Use an oiling system that ensures consistent oil flow from the pushrod cup to the shaft bearings and then on to the roller tip (see Figure A)

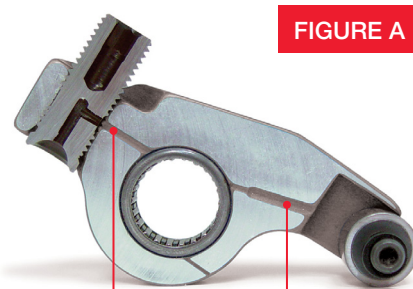

FIGURE A

INTERNAL OILING SYSTEM

MAKE	DESCRIPTION	RATIO		OFFSET		PART #
		IN.	EX.	IN.	EX.	
Chevrolet	Small Block RHS® Pro Action™ Aluminum	1.5	1.5	.250	.080	1511
	Small Block Brodix Track 1	1.6	1.5	.170	.080	1506
	Small Block Dart Iron Eagle	1.6	1.5	.170	.170	1503¹
	Small Block AFR#190-195-210	1.6	1.5	.250	.080	1502
	Small Block RHS® 23° Pro Elite™ CNC-Ported 240cc Runner	1.6	1.5	.375"	.170"	1524²
	Small Block Brodix 8X, 10X, 11X	1.6	1.5	.450	.080	1519
	Small Block GM Bowtie 18°	1.6	1.5	.550	.000	1508
	Big Block Standard/Dart Iron Eagle	1.7	1.7	.000	.000	1504
	Big Block RHS® Pro Action™ Aluminum 320/360 Runner	1.7	1.7	.000	.000	1520
	Big Block Brodix 2+, Dart 320/360	1.7	1.7	.000	.000	1505
	Big Block Brodix 2 Xtra	1.7	1.7	.000	.000	1507
	Big Block Brodix Big Duke/Dart Iron Eagle, World Products Grumpy	1.7	1.7	.000	.000	1512
	Big Block 18 Degree Brodix Big Duke/Dart Big Chief	1.7	1.7	.750	.400	1513
GM LS	LS1/LS2/LS6	1.7	1.7	.000	.000	1500⁴
	LS1/LS2/LS6	1.8	1.8	.000	.000	1501⁴
	LS3/L92	1.7	1.7	.215	.000	1521
	LS7	1.8	1.8	.350	.000	1523
	LS7/RHS® Raised Port	1.8	1.8	.420	.000	1525
Chrysler	Small Block (273-360) OEM Iron Head Single (OE Through Shaft Oiling)	1.5	1.5	.000	.000	1515
	Big Block (383-440) OEM Iron Head Single (OE Through Shaft Oiling)	1.5	1.5	.250	.080	1516
	Big Block (383-440) Indy Head 440-1 & 440-C Single (OE Through Shaft Oiling)	1.5	1.5	.800	.000	1517
	426 Hemi OEM Iron Head	1.6	1.5	1.950	.000	1522³
Ford	289-351W Production Head	1.6	1.6	.000	.000	1514
Pontiac	Edelbrock P8	1.5	1.5	.080	.080	1518
	867 with 40/60 Spacing	1.6	1.5	.450	.080	1519

Note: Custom applications available, call CAM HELP® 1.800.999.0853 or email camhelp@compcams.com.

¹ This system will not work on the 49cc Dart Iron Eagle Cylinder Heads

² Designed for RHS Part #12328 and #12329

³ Requires spray bar oiling or oiling valve cover

⁴ Requires valve cover spacer or baffle removal

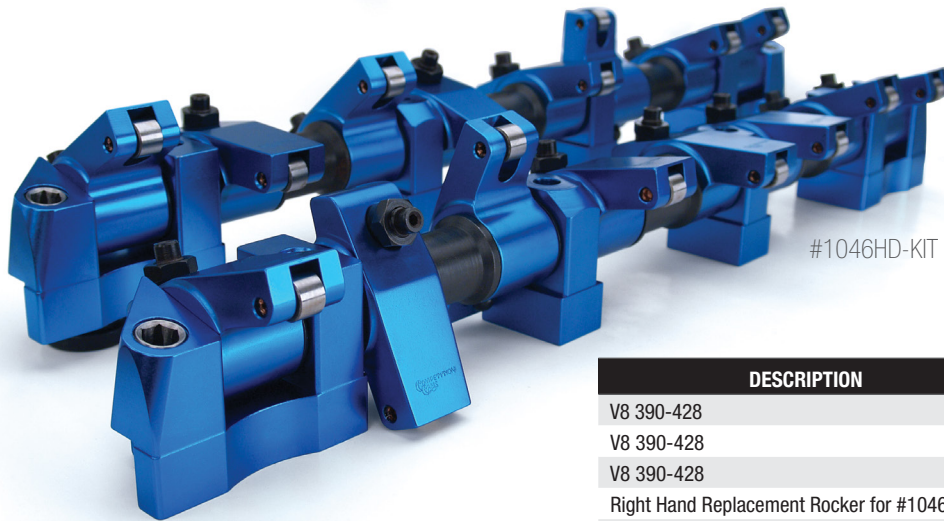

#1046HD-KIT

FORD FE SHAFT MOUNT ROCKER SYSTEMS

- Made from 7000 series aluminum
- HD Kit features 1.200" wide rocker bodies
- Withstand up to 450 lbs. of valve spring pressure
- Equipped with special end stands to provide valve train stability at higher RPM
- Feature top & bottom oil holes for added rocker lubrication
- Recommended for use with roller cams

DESCRIPTION	RATIO	PART #
V8 390-428	1.76	1046-16
V8 390-428	1.76	1046-KIT¹
V8 390-428	1.76	1046HD-KIT
Right Hand Replacement Rocker for #1046HD-KIT	1.76	1046HDR-1
Left Hand Replacement Rocker for #1046HD-KIT	1.76	1046HDL-1
V8 352-428 Hard Chrome Shaft	—	1047-2
V8 390-428 Rocker Spacer Set	—	1086
Spacer Kit for 1046HD-KIT	—	1046-SPK
End Stand Kit for #1046HD-KIT	—	1046-ESK
Center Stand Kit for 1046HD-KIT	—	1046-CS
Stud Kit for 1046HD-KIT	—	1046-STK
End Support Head Bolts	—	1408-4²

¹ Includes shafts & rockers assembled, spacers NOT included

² End support head bolts for use when head studs are not used

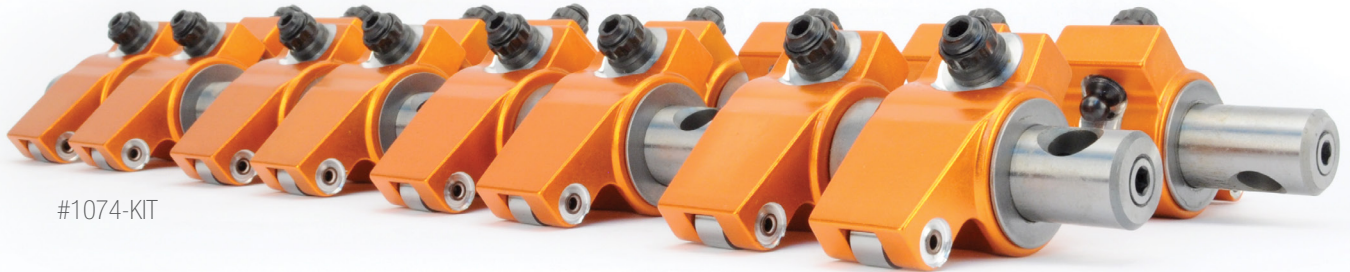

#1074-KIT

CHRYSLER SHAFT MOUNT ALUMINUM ROCKER SYSTEMS

- Constructed from an aluminum alloy with tensile strength of 80,000 psi
- Good choice for any race application

¹ Includes shafts, spacers & rockers assembled

MAKE	DESCRIPTION	STUD DIA.	RATIO	PART #
Chrysler	V8 273-360	Shaft	1.5	1074-16
	V8 273-360	Shaft	1.5	1074-KIT¹
	V8 273-360	Shaft	1.6	1076-16
	V8 273-360	Shaft	1.6	1076-KIT¹
	V8 383-440	Shaft	1.5	1071-16
	V8 383-440	Shaft	1.5	1071-KIT¹
	V8 383-440	Shaft	1.6	1073-16
	V8 383-440	Shaft	1.6	1073-KIT¹
	V8 273-360 Hard Chrome Shaft			1078-2
	V8 273-360 Hard Chrome Shaft, .100" Offset (For Spring Clearance)			1084-2
	V8 383-440 Hard Chrome Shaft			1072-2
	V8 383-440 Hard Chrome Shaft, .100" Offset (For Spring Clearance)			1085-2
	Spacers for #1074 & #1076 Rockers .480" Wide			1082-8
	Spacers for #1071 & #1073 Rockers .700" Wide			1083-8

APPLICATION	DESCRIPTION	PART #
AMC		
290-401 V8	1.6 Magnum Rockers & Magnum Pushrods	RPM1410-16
CHRYSLER		
Dodge Magnum V8 1992-02	1.6 Magnum Rockers, Magnum Pushrods, Guide Plates & Rocker Studs	1425-KIT
273-360 V8 w/ Hydraulic Lifters	1.5 Ultra Pro Magnum™ Rockers, Shafts, Spacers & Hi-Tech™ Pushrods	RP1622-16
273-360 V8 w/ Solid Lifters	1.5 Ultra Pro Magnum™ Rockers, Shafts, Spacers & Hi-Tech™ Pushrods	RP1623-16
FORD		
1968-89 289-302 Rail Type (All Except Hyd. Roller Engine)	1.6 Magnum Rockers & High Energy Pushrods™	RP1431-16
1968-89 289-302 Rail Type (All Except Hyd. Roller Engine)	1.6 Magnum Rockers & Magnum Pushrods	RPM1431-16
1968-89 289-302 Rail Type (All Except Hyd. Roller Engine)	1.7 Magnum Rockers & High Energy Pushrods™	RP1453-16
1968-89 289-302 Rail Type (All Except Hyd. Roller Engine)	1.7 Magnum Rockers & Magnum Pushrods	RPM1453-16
1968-89 289-302 Rail Type Retro-Fit Hydraulic Roller	1.6 Magnum Rockers & High Energy Pushrods™	RPR1428-16
1985-Present 302 HO w/ OE Hydraulic Roller Cam	1.6 Magnum Rockers & High Energy Pushrods™	RP1427-16
1985-Present 302 HO w/ OE Hydraulic Roller Cam	1.7 Magnum Rockers & High Energy Pushrods™	RP1450-16
1969-95 351W (All Except Hydraulic Roller Engine)	1.6 Magnum Rockers & High Energy Pushrods™	RP1436-16
1969-95 351W (All Except Hydraulic Roller Engine)	1.6 Magnum Rockers & Magnum Pushrods	RPM1436-16
CHEVROLET/GM		
173 V6 60°	1.52 Magnum Rockers & High Energy Pushrods™	RP1413-12
173 V6 60°	1.6 Magnum Rockers & High Energy Pushrods™	RP1414-12
262-400 V8	1.52 Magnum Rockers & High Energy Pushrods™	RP1412-16¹
262-400 V8	1.52 Magnum Rockers & Magnum Pushrods	RPM1412-16
262-400 V8	1.52 Ultra Pro Magnum™ Rockers & Magnum Pushrods	RPM1601-16
262-400 V8	1.5 Ultra Pro Magnum™ XD Rockers & Magnum Pushrods	RPM1801-16
262-400 V8 Retro-Fit Hydraulic Roller	1.52 Magnum Rockers & High Energy Pushrods™	RPR200¹
262-400 V8	1.52 Magnum Rockers, High Energy Pushrods™ & Guide Plates	RPG100
262-400 V8	1.6 Magnum Rockers & High Energy Pushrods™	RP1416-16¹
262-400 V8	1.6 Magnum Rockers & Magnum Pushrods	RPM1416-16
262-400 V8	1.6 Ultra Pro Magnum™ XD Rockers & Magnum Pushrods	RPM1802-16
262-400 V8 Retro-Fit Hydraulic Roller	1.6 Magnum Rockers & High Energy Pushrods™	RPR201¹
262-400 V8	1.6 Magnum Rockers, High Energy Pushrods™ & Guide Plates	RPG101
265-400 V8 for 1987 & Later w/ OE Hyd. Roller Cam & Non Self Aligning Rocker Arms	1.6 Magnum Rockers, High Energy Pushrods & Guide Plates	RPG103
265-400 V8 for 1987 & Later w/ OE Hydraulic Roller Cam	1.52 Magnum Rockers & High Energy Pushrods™	RP1417-16¹
265-400 V8 for 1987 & Later w/ OE Hydraulic Roller Cam	1.52 Magnum Rockers & Magnum Pushrods	RPM1417-16
265-400 V8 for 1987 & Later w/ OE Hydraulic Roller Cam	1.52 Ultra Pro Magnum™ Rockers & Magnum Pushrods	RPM1617-16
265-400 V8 for 1987 & Later w/ Flat Tappet Cam	1.52 Magnum Rockers & High Energy Pushrods™	RPE1417-16¹
265-400 V8 for 1987 & Later w/ OE Hyd. Roller Cam & Non Self Aligning Rocker Arms	1.52 Magnum Rockers & High Energy Pushrods™	RPH300¹
265-400 V8 for 1987 & Later w/ OE Hyd. Roller Cam & Non Self Aligning Rocker Arms	1.52 Magnum Rockers, High Energy Pushrods™ & Guide Plates	RPG102
265-400 V8 for 1987 & Later w/ OE Hydraulic Roller Cam	1.6 Magnum Rockers & High Energy Pushrods™	RP1418-16¹
265-400 V8 for 1987 & Later w/ OE Hydraulic Roller Cam	1.6 Magnum Rockers & Magnum Pushrods	RPM1418-16
265-400 V8 for 1987 & Later w/ OE Hydraulic Roller Cam	1.6 Ultra Pro Magnum™ Rockers & Magnum Pushrods	RPM1618-16
265-400 V8 for 1987 & Later w/ Flat Tappet Cam	1.6 Magnum Rockers & High Energy Pushrods™	RPE1418-16¹
265-400 V8 for 1987 & Later w/ OE Hyd. Roller Cam & Non Self Aligning Rocker Arms	1.6 Magnum Rockers & High Energy Pushrods™	RPH301¹
396-454 V8	1.72 Magnum Rockers & High Energy Pushrods™	RP1411-16
396-454 V8	1.72 Magnum Rockers & Magnum Pushrods	RPM1411-16
396-454 V8	1.7 Ultra Pro Magnum™ Rockers & Magnum Pushrods	RPM1620-16
396-454 V8	1.7 Ultra Pro Magnum™ XD Rockers & Magnum Pushrods	RPM1820-16
396-454 V8 Retro-Fit Hydraulic Roller	1.72 Magnum Rockers & High Energy Pushrods™	RPR205
Mark V V8	1.72 Magnum Rockers, High Energy Pushrods™ & Rocker Studs	RPS300
Mark V V8	1.72 Magnum Rockers, Magnum Pushrods & Rocker Studs	RPS301
Mark VI V8	1.72 Magnum Rockers, High Energy Pushrods™ & Rocker Studs	RPS302
OLDSMOBILE		
350-403 V8	1.6 Magnum Rockers, High Energy Pushrods™, Rocker Arm Studs & Guide Plates	1441-KIT
455 V8	1.6 Magnum Rockers, High Energy Pushrods™, Rocker Arm Studs & Guide Plates	1442-KIT
PONTIAC		
1965-79 326-455 V8	1.52 Magnum Rockers & High Energy Pushrods™	RP1451-16
1965-79 326-455 V8	1.52 Magnum Rockers & Magnum Pushrods	RPM1451-16
1965-79 326-455 V8	1.65 Magnum Rockers & High Energy Pushrods™	RP1452-16
1965-79 326-455 V8	1.65 Magnum Rockers & Magnum Pushrods	RPM1452-16

¹ Use -12 for V6 engines

ROCKER ARM ADJUSTING NUTS

- Tapered for extra strength in locking areas
- High Energy™ and Magnum Polylocks are best for moderate lift and spring pressure applications
- Hi-Tech™ Polylocks work well in all high end race applications
- Stud girdle polylocks are precision ground for minimum runout

DESCRIPTION	STUD DIA.	PART #
High Energy™ Polylock	3/8"	4604-16
1.125" Tall Polylock for High Energy™ Aluminum Rockers	3/8"	4631-16
High Energy™ Polylock	7/16"	4606-16
1.125" Tall Polylock for High Energy™ Aluminum Rockers	7/16"	4630-16
Magnum Polylock	3/8"	4602-16
Magnum Polylock	7/16"	4603-16
Hi-Tech™ Polylock for Ultra Pro Magnum™/Ultra Pro Magnum™ XD Rockers	3/8"	4601-16
Hi-Tech™ Polylock for Ultra Pro Magnum™/Ultra Pro Magnum™ XD Rockers	7/16"	4600-16
Hi-Tech™ Polylock for Ultra Pro Magnum™/Ultra Pro Magnum™ XD Rockers	1/2"	4657-16
Stud Girdle Adjusting Nut	7/16"	4508-1
Stud Girdle Adjusting Nut (12) #4508 & (4) #4508S	7/16"	4508-16
Stud Girdle Adjusting Nut (w/ Snap Ring to Hold Girdle Bar)	7/16"	4508S-1
Stud Girdle Adjusting Nut	3/8"	4509-1
Stud Girdle Adjusting Nut (12) #4509 & (4) #4509S	3/8"	4509-16
Stud Girdle Adjusting Nut (w/ Snap Ring to Hold Girdle Bar)	3/8"	4509S-1
Stud Girdle Adjusting Nut, Intake BB Chevrolet	7/16"	4510-8
Stud Girdle Adjusting Nut, BB Ford Threaded Through Full Length	7/16"	4511-16

REPLACEMENT PARTS

GM Gen III/LS1/LS2/LS6 Adjusting Nut	3/8"	4654-16 ¹
Replacement Nut for Magnum Rockers	3/8"	1400N-16
Replacement Nut for Magnum Rockers	7/16"	1401N-16
Replacement Nut for Magnum Rockers	10mm	1403N-12
Pivot Ball Replacement for Magnum Rockers	3/8"	1400B-16
Pivot Ball Replacement for Magnum Rockers	7/16"	1401B-16
Pivot Ball Replacement for Magnum Rockers	10mm	1403B-12
Replacement Nut & Screw for #1071, #1073, #1074, #1076 Rockers	—	1406-1
Replacement Nut & Screw for #1046 Rocker	—	1407-1

Note: Dash -1 indicates one piece, dash -8 indicates a set of eight, dash -16 indicates a set of sixteen.

¹ Replacement components only, must be used with #16755-KIT and #16765-KIT

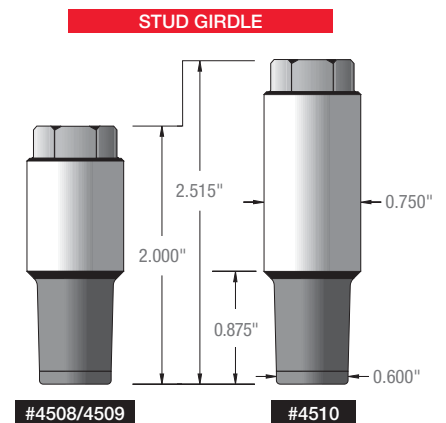
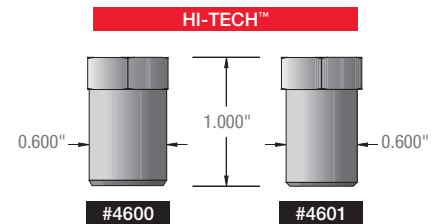
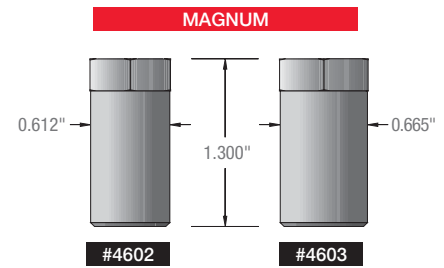

Note: Diameters are nominal specifications and should be considered maximum dimension.

ROCKER ARM ADJUSTING NUT KITS

Many of the popular engine families utilize a positive stop type of rocker arm attachment, which does not allow for any adjustment, and consequently there is no consideration for different cam sizes or other modifications to the engine block and heads. For that reason, COMP® has designed a kit to convert this setup to a fully adjustable valve train.

On the 302-351W Fords, simply remove the standard adjusting nut, slip the spacer over the stud, install the new nut and adjust the valves as necessary. On the Mark V and VI Big Block Chevrolet engines, replace the screw-in studs with those provided, slip the spacer insert through the rocker arm ball, and adjust with the new adjusting nut. These kits are a simple, easy and inexpensive alternative to give the flexibility of an adjustable valve train.

DESCRIPTION	STUD DIA.	PART #
Small Block Ford w/ Non-Adjusting Rockers, Includes: (16) #4610-W FS/FW Washer, #4610-N FS/FW 5/16" Adjusting Nut	5/16"	4610-16
Big Block Chevrolet Late Model Adjusting Rocker Kit, Includes: (16) #4514 Studs, #4514SP Spacer, #1401-N Rocker Nut	7/16"	4514-KIT





#4500

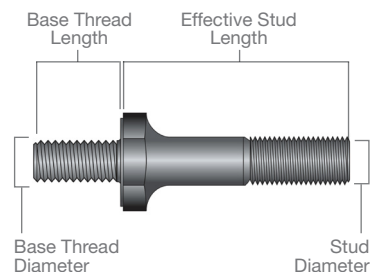

ROCKER ARM STUDS

COMP Cams® takes pride in having the finest rocker arm studs available on the market. The High Energy™ and Magnum series studs work well in applications with moderate lifts and spring pressures and are available in the popular 3/8" and 7/16" sizes. When ultimate strength is required, as with high RPM roller cam applications, the Hi-Tech™ Race Stud is the answer. This stud has a thin jam nut for rocker clearance, rolled threads for maximum contact and a ground-flat top so that accurate valve adjustment can be achieved and maintained. The diameter of the jam nut is larger in order to spread the load over a larger area. All COMP Cams® studs have generous radii and a black oxide finish.

DESCRIPTION	BASE THREAD		STUD DIA.	EFFECTIVE STUD LENGTH	PART #
	DIAMETER	LENGTH			
High Energy™ Rocker Stud	7/16"	.680"	3/8"	1.750"	4500-16
High Energy™ Rocker Stud	7/16"	.825"	7/16"	1.750"	4501-16
Magnum Rocker Stud	7/16"	.680"	3/8"	1.750"	4502-16
Magnum Rocker Stud	7/16"	.825"	7/16"	1.750"	4503-16
Magnum Rocker Stud for Ford	5/16"	.680"	3/8"	1.750"	4504-16
Magnum Rocker Stud for Oldsmobile	5/16"	.580"	3/8"	1.520"	4542-16¹
Magnum Rocker Stud for Dodge Magnum V6, V8, V10	5/16"	.580"	3/8"	1.520"	4542-16^{1,2}
Hi-Tech™ Race Rocker Stud	7/16"	.680"	3/8"	1.750"	4505-16
Hi-Tech™ Race Rocker Stud	7/16"	.710"	3/8"	1.895"	4515-16
Hi-Tech™ Race Rocker Stud	7/16"	.710"	7/16"	1.750"	4506-16
Hi-Tech™ Race Rocker Stud	7/16"	.735"	1/2"	1.900"	4543-16
Hi-Tech™ Race Exhaust for 396-454 for Chevrolet w/ Aluminum Heads	7/16"	1.680"	7/16"	2.000"	4507-8
Hi-Tech™ Race Rocker Stud for GM Gen III/LS1/LS2/LS6	8mm	.800"	3/8"	1.500"	4554-16³
Hi-Tech™ Race Rocker Stud for Chevrolet Big Block	7/16"	.750"	7/16"	1.900"	4512-16
Hi-Tech™ Race Rocker Stud for Chevrolet Big Block Mark V & Mark VI	3/8"	.750"	7/16"	1.900"	4514-16

¹ Must be used with guide plates

² For V6 use -12 suffix, for V10 use -20 suffix

³ Replacement components only, must be used with #16755-KIT & #16765-KIT, see page 274 for more information

STUD BOSS CUTTER

- When using screw-in studs on a factory head it is necessary to machine down the stud boss equal to the thickness of the new stud's jam nut plus the guide plate thickness
- Includes a universal arbor that also acts as a pilot/guide and fits into the original stud hole

DESCRIPTION	O.D.	I.D.	PILOT DIA.	PART #
Stud Boss Cutter	1.150	.320/.330	.364/.365	4729

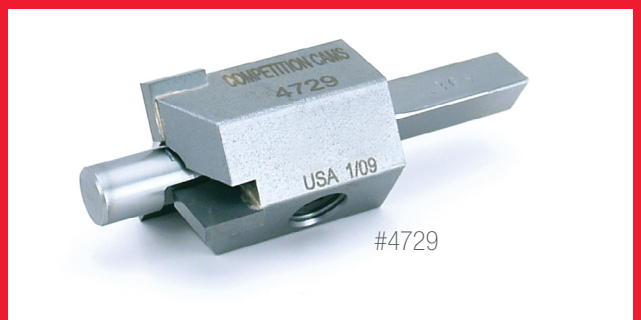

STUD GIRDLES

- Solid bar, one-piece design ties studs together and properly locates them
- Two-piece, spring loaded designs available for Small Block Chevy
- Constructed of 6061-T6 aluminum for light weight and anodized for durability
- Kits come complete with hex head adjusting nuts, interlocking set screws and all hardware



#4004

MAKE	DESCRIPTION	STUD DIA.	PART #
Chevrolet	265-400 Solid Bar Design	3/8"	4007
	265-400 Solid Bar Design	7/16"	4009
	265-400 Spring Loaded Design	3/8"	4001
	265-400 Spring Loaded Design	7/16"	4004
	265-400 Brodix Pontiac Spring Loaded Design, 40/60 Stud Spacing	3/8"	4019
	265-400 Brodix Pontiac Spring Loaded Design, 40/60 Stud Spacing	7/16"	4018
	265-400 Aluminum Bowtie Cylinder Head Solid Bar Design	7/16"	4010¹
	265-400 Brownfield Cylinder Head Solid Bar Design	7/16"	4011
	265-400 Brodix Pontiac Solid Bar Design 40/60 Stud Spacing	7/16"	4012
	396-454 Solid Bar Design Standard Stud Spacing, Brodix-2	7/16"	4021
Ford	289-302, 351W Standard Head	3/8"	4013
	289-302, 351W Standard Head	7/16"	4014
	289-302, 351W RHS® Pro Action™ or Motorsport Aluminum Head	7/16"	4015
	351C Boss, Motorsport Aluminum Head	7/16"	4016
	429-460 TFS Motorsport Aluminum Head, Will Not Fit Stock OEM Head	7/16"	4017
	429-460 Production Heads, Including Cobra Jet & Super Cobra Jet Models	7/16"	4034
Pontiac	265-455 Solid Bar Design	7/16"	4051

Note: All COMP Cams® Ford stud girdles shown above are solid bar design.

¹ Cast iron Bowtie heads & Dart Iron Eagle heads use standard Chevrolet girdles Part #4007, #4009, #4001 & #4004



#4020



#4023

#4022

UNDRILLED GIRDLE BAR

- Allows measuring and drilling of bar to your own specs
- Intended for use on small block engines but may also work in other applications

DESCRIPTION	STUD DIA.	PART #
Undrilled Girdle Bar 17.5" x 1.5"	1.500"	4020

ULTRA-GOLD™ STUD GIRDLES

MAKE	DESCRIPTION	STUD DIA.	PART #
Chevrolet	265-400 Solid Bar Design	3/8"	4026
	265-400 Solid Bar Design	7/16"	4023
	265-400 Spring Loaded Design	3/8"	4027
	265-400 Spring Loaded Design	7/16"	4022
	265-400 Spring Loaded for RHS® Head	7/16"	4036
	396-454 Solid Bar Design	7/16"	4025
	396-454 for RHS® Head	7/16"	4035
Ford	289-302, 351W Solid Bar Design	3/8"	4030
	289-302, 351W Solid Bar Design	7/16"	4024



GUIDE PLATES

- Designed using stereo lithography techniques for accurate fit; hardened and black oxide finished
- Feature exact stud placement and rounded contact points
- Necessary for high lift/spring pressure environments of performance engines

2-PIECE ADJUSTABLE GUIDE PLATES

- Available for Small and Big Block Chevy and Small Block Ford applications
- Designed for use on cylinder heads with relocated intake ports
- Big Block Chevy application designed for use with RHS® or other aftermarket heads with relocated intake ports
- Able to be welded after final adjustment (SBC and SBF only); BBC is bolt-together design
- Contoured & clearanced for head bolts

MAKE	DESCRIPTION	TYPE	PUSHROD SIZE	STUD DIA.	PART #
STANDARD ONE-PIECE NON-ADJUSTABLE¹					
AMC	290-401	Flat	5/16"	7/16"	4851-8
Chevrolet	265-400	Raised	5/16"	7/16"	4800-8
	265-400	Raised	3/8"	7/16"	4802-8
	265-400	Flat	5/16"	7/16"	4808-8
	265-400	Flat	3/8"	7/16"	4810-8
	396-454	Raised	3/8"	7/16"	4806-8
	396-454	Raised	7/16"	7/16"	4820-8
GM LS	GM LS Series	Flat	5/16"	8mm	4854-8²
	GM LS Series	Flat	3/8"	8mm	4856-8²
	GM LS3/L92	Flat	5/16"	8mm	4840-8
Dodge	Magnum V8	Flat	5/16"	5/16"	4825-8³
Ford	289-351W	Flat	5/16"	7/16"	4816-8
	289-351W	Flat	3/8"	7/16"	4818-8
	Cleveland	Raised	5/16"	7/16"	4803-8
	Cleveland	Raised	3/8"	7/16"	4804-8
	429-460	Raised	5/16"	7/16"	4834-8
	429-460	Raised	3/8"	7/16"	4838-8
Oldsmobile	350-455	Flat	5/16"	5/16"	4842-8⁴
	350-455	Flat	3/8"	5/16"	4843-8⁴
Pontiac	350-455	Flat	5/16"	7/16"	4851-8
	350-455	Flat	3/8"	7/16"	4852-8
TWO-PIECE ADJUSTABLE					
Chevrolet	265-400	Flat Adjustable	5/16"	7/16"	4835-8
	265-400	Flat Adjustable	3/8"	7/16"	4839-8
	396-454	Raised Adjustable	3/8"	7/16"	4811-8⁵
Ford	289-351W	Flat Adjustable	5/16"	7/16"	4835-8⁵
	289-351W	Flat Adjustable	3/8"	7/16"	4839-8

¹ Some applications require machine work

² Replacement components only, must be used with #16755-KIT and #16765-KIT, see page 274 for more information

³ Only for engines with stud mount rockers. No machine work required. For 3.9L V6, use -6 suffix, for 8.0L V10 trucks, use -10 suffix.

⁴ No machine work required with Part #4542-16 stud

⁵ Requires 7/16" stud base thread (standard on RHS® and aftermarket heads)



REV KITS

In some endurance uses and most oval track applications, it is necessary to use a rev kit for the lifter to precisely follow the profile of the cam. This safety measure ensures that in the event of pushrod or rocker arm failure, the lifter will not come out of the lifter bore. This could cause a loss of oil pressure and subsequent engine failure.

- Constructed from the toughest extruded aluminum (except Big Block Chevrolet, which is a casting)
- Kit comes with all necessary springs and buttons
- Notched to fit the block & should require no machine work
- Angle of the spring pocket in the bar has been changed to duplicate the lifter angle in the block

DESCRIPTION	PART #
Chevrolet 90° V6 w/ .842" Lifter Diameter	4006
Rev Kit Plate - Fits #4006 V6	4006-P
Chevrolet 265-400 Kit w/ .842" Lifter Diameter	4000
Chevrolet 265-400 w/ .874" Lifter Diameter	4008
Chevrolet 265-400 Rev Kit Buttons - Fits #4000, #4006, #4008	4000B-16¹
Rev Kit Button (.874" Diameter)	4008B-16¹
Chevrolet 265-400 Rev Kit Plate - Fits #4000, #4008	4000-P
.940" Inner (Blue) - Fits #4000, #4006, #4008	974-1
Chevrolet 396-454 w/ .842" Lifter Diameter	4003
Chevrolet 396-454 Rev Kit Buttons - Fits #4003, #4005	4003B-16¹
Chevrolet 396-454 Rev Kit Plate - Fits #4003	4003-P
.970" Inner - Fits #4003, #4005	973-1

¹ For single piece use -1 suffix

Note: For use with COMP Cams® full round body solid roller lifters only. It is recommended to have 30-50 lbs of spring load on the lifter when on the base circle. Open load will vary, depending on lobe lift.

VALVE SPRING CHECKLIST

Proper selection of the valve spring begins with identifying the application and selecting all of the valve train components necessary to achieve the engine builders' goals. Improper selection of the wrong valve spring is one of the most common causes of engine failure. Other common causes are the incorrect installation and improper handling of the valve springs.

SELECTING A SPRING

1. Use only the valve springs that will give the recommended spring pressure with the valve both on the seat and at maximum lift.
2. The O.D. of the recommended valve spring may require that the spring pocket of the head be machined to a bigger size.
3. We have a large selection of steel and titanium retainers (pages 304-306), hardened steel spring seat cups and I.D. locators (page 309) to match our springs. A spring that is contained properly at the retainer and the cylinder head will offer the longest possible service life.

PROPER SPRING HANDLING

1. Handle springs with care. Never place in a vise, grab with pliers or hit them with a hammer. This will damage the surface of the spring, which will cause it to fail.
2. When separating double or triple springs, use only a durable plastic object that cannot harm the shot-peened surface of the spring.
3. Valve springs are shipped with a rust preventative coating that should remain on the spring throughout engine assembly. Do not clean springs with acidic or evaporative cleaners. This causes rapid drying and promotes the formation of rust on the surface, which can cause catastrophic failures. Even a slight amount of corrosion can be a problem.
3. When installing springs, use COMP Cams® Valve Train Assembly Spray (Part #106) to ease assembly and improve the life of the spring.

CHECKING LOADS

1. COMP Cams® has matched each set of springs for load consistency. A variance of +/-10% is acceptable for new springs.
2. When checking the spring loads on a load tester, measure and note the thickness of the retainer where the outer spring sits. Assemble the retainer on the spring and place on the base of the spring checker.
3. Compress the spring to the desired installed height. This is the measurement between the top of the spring (on the bottom side of the retainer where the outer spring sits) and the bottom of the spring on the base.

BREAKING IN A SPRING

1. It is important for new springs to take a heat-set. Upon initial start-up, limit RPM to 1500 to 2000 until the temperature has reached operating levels. Shut off the engine and allow the springs to cool to room temperature. This usually will eliminate early breakage and prolong spring life. After the spring has been broken-in, it is common for it to lose a slight amount of pressure. However, it should then remain constant unless the engine is abused and the spring becomes overstressed. If this occurs the springs must either be replaced or shimmed to the correct pressure.

INSTALLATION

1. Before installing the spring on the cylinder heads, check the installed spring height. This is the distance from the bottom of the retainer to the surface where the spring rests on the head. First, install the valve in the guide, then install the retainer and valve locks. Pull the retainer tightly against the valve locks while holding the valve assembly steady. Measure the distance between the spring seat and the outside step of the retainer using your height micrometer (Part #4928 or #4929). After you have measured all the valves, find the shortest height. This will become the spring's installed height on your heads. If your combination includes a dual or triple spring assembly, it will be necessary to allow for the inner steps of the retainer.
2. It will then be necessary to use shims to obtain the shortest installed height ($\pm .020$ " is acceptable) on the remaining valves.
3. Before removing the retainers, measure the distance from the bottom of the retainer to the top of the valve seal (Diagram A). This distance must be greater than the lift of the valve. If not, the guide must be machined to avoid cam failure.
4. Once the valve springs have been installed, it is important to check for coil bind. This means that when the valve is fully open, there must be a minimum of .060" clearance between the coils of both the inner and outer springs. If this clearance doesn't exist, you must change either the retainer or the valve to gain more installed height, or change to a spring that will accommodate more lift or machine the spring seat for extra depth.
5. Always check for clearance between the retainer and the inside face of the rocker arm. You should check to see that you have the proper rocker arm/retainer combination and rocker geometry.
6. To aid in the engine break in process, spray the springs, rocker arms and pushrods with COMP Cams® Valve Train Assembly Spray (Part #106).

DIAGRAM A

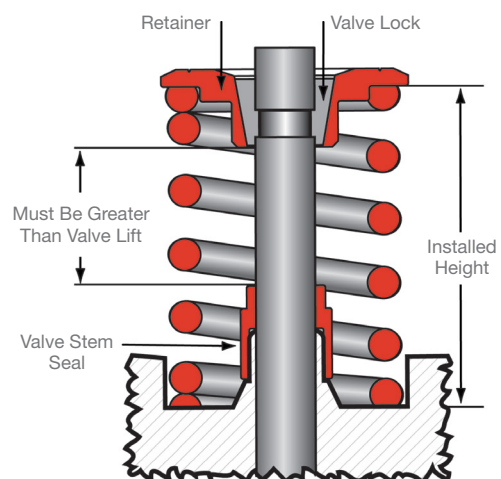

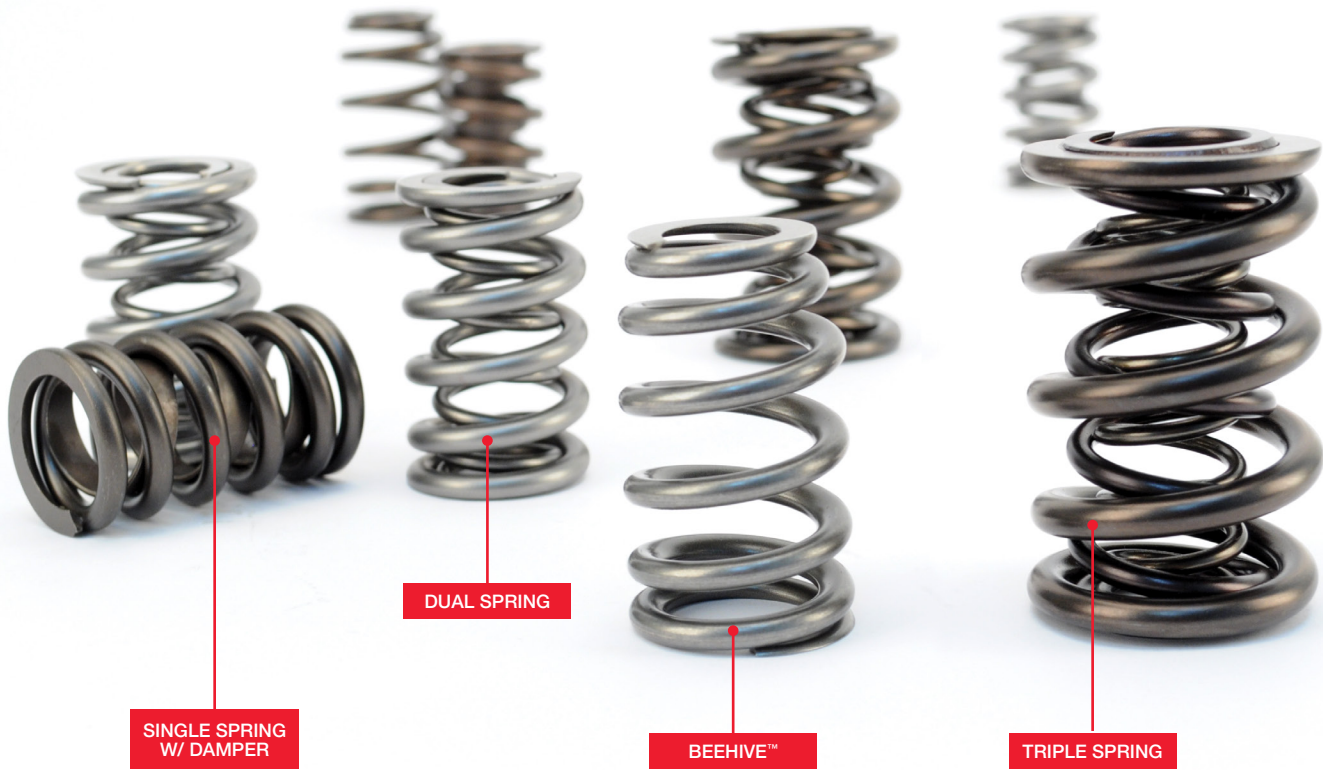

PERFORMANCE STREET

COMP Cams® Performance Street Valve Springs provide extra stability and endurance. These are the most popular COMP® springs for street applications and are used primarily by customers with performance hydraulic flat tappet & hydraulic rollers in mind. COMP® technicians will match the proper spring for each customer's given lift and install height requirements.

RACE/STREET

Race/Street Valve Springs provide extra stability and endurance for most race/street applications. These springs are used by the street customer who has chosen a larger lift cam with race being the primary focus, along with limited street use. COMP® technicians will match the proper spring for the customer exploring more race than street driving for larger hydraulic, hydraulic rollers and some solid flat tappet profiles, given lift and install height requirements.

RACE SPORTSMAN

Race Sportsman Valve Springs offer extra stability and endurance for those weekend-minded racers in oval track and bracket drag race applications. These springs are the most popular choice for flat tappet hydraulic and solid lifter and larger hydraulic roller applications. COMP® technicians will match the proper springs for each customer's given lift and install height requirements.

RACE ENDURANCE

COMP Cams® Race Endurance Valve Springs offer extra stability and endurance based on enhancements added during the finishing process. These are the most popular springs for the serious oval track and drag race customer using nitrided solid lifters and roller cams. COMP® technicians will match the proper springs for the customer's given lift and install height requirements. Race Endurance Springs typically run a little closer to coil bind when better valves, retainers and keepers are present.

RACE EXTREME

Race Extreme Valve Springs are for the serious racer because they offer increased stability and endurance due to enhancements added during the finishing process. These are the best choice for the roller cam customer with higher lift and RPM in mind. These springs must be recommended with valve, retainer and keeper weights all being considered first. COMP® technicians will match the proper spring given the application, RPM and lobe families for each individual application.

OUR EXPERIENCED TEAM OF
TECHNICIANS CAN HELP ANSWER
YOUR VALVE TRAIN QUESTIONS

CAMHELP® 800.999.0853

MAX LIFT	O.D. OF BASE	O.D. OF TOP	I.D. OF BASE	I.D. OF TOP	INSTALLED LOAD	INSTALLED HEIGHT	OPEN LOAD	OPEN HEIGHT	COIL BIND	RATE (LBS./IN.)	PART #
PERFORMANCE STREET											
.450	1.254	1.254	.880	.880	105	1.700	273	1.250	1.150	373	981
.500	1.105	.943	.742	.580	90	1.470	252	.970	.900	324	26123
.525	1.240	1.065	.825	.650	110	1.700	292	1.175	1.115	347	26981
.550	1.061	.959	.738	.636	93	1.570	198	1.020	.952	191	26113
.550	1.415	1.065	1.000	.650	137	1.700	305	1.100	1.060	280	26995
.600	1.290	1.055	.885	.650	105	1.800	293	1.200	1.100	313	26915
.625	1.415	1.065	1.000	.650	109	1.800	284	1.175	1.060	280	26986
.625	1.310	1.075	.885	.650	125	1.800	367	1.150	1.100	372	26918
.650	1.509	1.509	.697	1.125	112	1.900	355	1.200	1.175	347	924
RACE STREET											
.600	1.101	1.013	.738	.650	120	1.640	275	1.040	.970	258	26125
.600	1.445	1.095	1.000	.650	155	1.880	377	1.280	1.230	370	26120
.650	1.300	1.300	.655	.655	135	1.770	400	1.120	1.040	408	26921
.650	1.550	1.550	.795	.795	153	1.900	383	1.250	1.160	354	930
.660	1.320	1.320	.680	.680	141	1.810	405	1.150	1.100	400	26925
.675	1.320	1.320	.654	.654	129	1.835	470	1.160	1.100	505	26926
.750	1.590	1.186	1.135	.731	150	2.000	375	1.250	1.130	300	26095
RACE SPORTSMAN											
.575	1.269	1.269	.711	.711	130	1.750	391	1.175	1.100	454	941
.600	1.320	1.320	.920	.920	103	1.780	325	1.160	1.100	356	26975¹
.600	1.475	1.475	.712	.712	133	1.900	332	1.300	1.200	332	950
.650	1.454	1.185	1.000	.731	160	1.800	420	1.150	1.100	400	26056
.650	1.550	1.550	.795	.795	160	1.880	383	1.250	1.160	354	928
.650	1.585	1.204	1.112	.731	150	1.925	410	1.275	1.225	400	26055
.675	1.320	1.320	.654	.654	129	1.835	470	1.160	1.100	505	26526
RACE ENDURANCE											
.625	1.550	1.550	.752	.752	178	1.900	459	1.275	1.200	449	26094
.650	1.535	1.535	.754	.754	148	1.880	432	1.230	1.160	437	929
.650	1.539	1.539	.731	.731	195	2.000	563	1.250	1.135	502	26097
.650	1.539	1.539	.731	.731	197	1.950	545	1.250	1.175	498	927
.650	1.550	1.550	.812	.812	240	1.900	598	1.250	1.160	551	943
.700	1.550	1.550	.812	.812	230	2.000	580	1.300	1.230	500	26089
.700	1.550	1.550	.812	.812	240	2.000	608	1.300	1.230	526	955
.700	1.550	1.550	.824	.824	200	1.800	596	1.100	1.050	566	917
.750	1.549	1.549	.719	.719	225	2.050	633	1.300	1.192	544	26115
RACE EXTREME											
.750	1.620	1.620	.846	.846	230	1.950	710	1.200	1.100	640	951
.750	1.625	1.625	.769	.769	250	2.050	672	1.250	1.184	563	26099
.800	1.645	1.645	.635	.635	250	2.050	800	1.250	1.130	688	946
.800	1.645	1.645	.635	.635	338	2.000	849	1.250	1.145	681	947
.900	1.500	1.500	.719	.719	325	2.100	1045	1.200	1.130	800	26956
.900	1.645	1.645	.635	.635	332	2.100	950	1.200	1.130	687	948
.900	1.680	1.680	.635	.635	382	2.100	1067	1.200	1.130	761	26082
.950	1.500	1.500	.719	.719	405	2.150	1166	1.200	1.130	788	26957
1.000	1.500	1.500	.719	.719	445	2.175	1245	1.175	1.130	830	26955
1.000	1.686	1.686	.634	.634	342	2.200	1054	1.200	1.161	712	26028

¹ Works with GM 604 circle track crate engines



#26918CS-KIT

GM LS BEEHIVE™ VALVE SPRING KITS

- Kits for hydraulic roller cams that include carefully matched Beehive™ Springs, retainers, locks, seals and spring seats
- Kits available with steel, tool steel or titanium retainers
- .600" Maximum lift for kits including Part #26915 valve springs
- .625" Maximum lift for kits including Part #26918 valve springs

COMPONENTS	COMPONENT PART #s	KIT PART #
PART #26915		
Beehive™ Valve Springs	26915-16	26915CS-KIT
Steel Retainers	774-16	
7° Steel Valve Locks	623-16	
Valve Seals	511-16	
Spring Seats	4705-16	
Beehive™ Valve Springs	26915-16	26915TS-KIT
Lightweight Tool Steel Retainers	1772-16	
7° Steel Valve Locks	623-16	
Valve Seals	511-16	
Spring Seats	4705-16	
Beehive™ Valve Springs	26915-16	26915TI-KIT
Titanium Retainers	772-16	
7° Steel Valve Locks	623-16	
Valve Seals	511-16	
Spring Seats	4705-16	

COMPONENTS	COMPONENT PART #s	KIT PART #
PART #26918		
Beehive™ Valve Springs	26918-16	26918CS-KIT
Steel Retainers	774-16	
7° Steel Valve Locks	623-16	
Valve Seals	511-16	
Spring Seats	4705-16	
Beehive™ Valve Springs	26918-16	26918TS-KIT
Lightweight Tool Steel Retainers	1772-16	
7° Steel Valve Locks	623-16	
Valve Seals	511-16	
Spring Seats	4705-16	
Beehive™ Valve Springs	26918-16	26918TI-KIT
Titanium Retainers	772-16	
7° Steel Valve Locks	623-16	
Valve Seals	511-16	
Spring Seats	4705-16	

GM LS DUAL VALVE SPRING KITS

- Dual valve spring kits designed for hydraulic roller and some solid roller camshafts
- Include matched valve springs, retainers, locks, seals & seats
- Kits available with tool steel or titanium retainers
- .660" Maximum lift for kits including Part #26925 springs
- .675" Maximum lift for kits including Part #26926 springs

COMPONENTS	COMPONENT PART #s	KIT PART #
PART #26925		
Street/Strip Dual Valve Springs	26925-16	26925TS-KIT
Lightweight Tool Steel Retainers	1717-16	
7° Steel Valve Locks	623-16	
Valve Seals	511-16	
Spring Seats	4695-16	
Street/Strip Dual Valve Springs	26925-16	26925TI-KIT
Titanium Retainers	717-16	
7° Steel Valve Locks	623-16	
Valve Seals	511-16	
Spring Seats	4695-16	

COMPONENTS	COMPONENT PART #s	KIT PART #
PART #26926		
Street/Strip Dual Valve Springs	26926-16	26926TS-KIT
Lightweight Tool Steel Retainers	1779-16	
7° Steel Valve Locks	623-16	
Valve Seals	511-16	
Spring Seats	4695-16	
Street/Strip Dual Valve Springs	26926-16	26926TLC-KIT
Lightweight Tool Steel Retainers	1777-16	
7° Steel Valve Locks	648-16	
Valve Seals	518-16	
Spring Seats	4682-16	
O.D. Cups	4709-16	
Street/Strip Dual Valve Springs	26926-16	26926TI-KIT
Titanium Retainers	779-16	
7° Steel Valve Locks	623-16	
Valve Seals	511-16	
Spring Seats	4695-16	

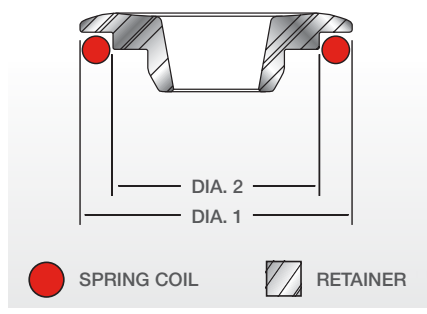

COMPONENTS VALVE SPRINGS

BEEHIVE™ VALVE SPRINGS

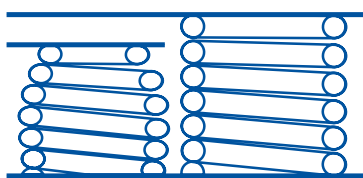

Beehive Shape Reduces Spring & Retainer Weight

- More stability, higher RPM, longer life and more horsepower
- Requires less spring pressure for better valve control
- Reduces the weight of the spring and allows a smaller, lighter retainer

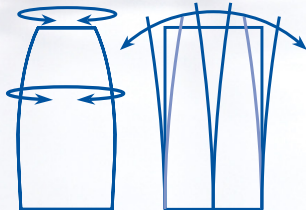

Unique Design Yields Greater Spring Stability

- Handles stress more efficiently
- Increases harmonic resistance for greater stability
- Eliminates damaging harmonics
- Increases high RPM horsepower and durability

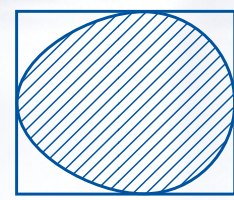

Oval/Multi-Arc Wire Shape

- Places the maximum area of the wire at the point of highest stress
- Handles stress more efficiently
- Allows better heat dissipation for longer life of the spring

	O.D. DIA. 1	I.D. DIA. 2	SEAT LOAD	OPEN LOAD	COIL BIND	RATE (LBS./IN.)	PART #	TITANIUM RETAINER	STEEL RETAINER	LOCATOR	SHIMS																																																																																																																																																																											
Top	.943	.580	90 @ 1.470	252 @ .970	.900	324	26123	798	799	N/A	N/A																																																																																																																																																																											
Bottom	1.105	.742										Top	.943	.580	90 @ 1.470	252 @ .970	.900	324	26523¹	798	799	N/A	N/A	Bottom	1.105	.742	Top	.959	.636	93 @ 1.570	198 @ 1.020	.952	191	26113	702, 791	700, 792	N/A	N/A	Bottom	1.061	.738	Top	1.013	.650	120 @ 1.640	275 @ 1.040	.970	258	26125	702	700	N/A	N/A	Bottom	1.101	.738	Top	1.055	.650	105 @ 1.800	293 @ 1.200	1.100	313	26915	762, 772, 788	761, 774, 783, 787	4705	4753	Bottom	1.290	.885	Top	1.065	.650	110 @ 1.700	292 @ 1.175	1.115	347	26981	788	787, 795	4693	4753	Bottom	1.240	.825	Top	1.065	.650	109 @ 1.800	284 @ 1.175	1.060	280	26986	788	787, 795	4696	4755	Bottom	1.415	1.000	Top	1.065	.650	137 @ 1.700	305 @ 1.100	1.060	280	26995	788	787, 795	4696	4755	Bottom	1.415	1.000	Top	1.075	.650	125 @ 1.800	367 @ 1.150	1.100	372	26918¹	762, 772, 788	761, 774, 783, 787, 795	4705	4753	Bottom	1.310	.885	Top	1.095	.650	155 @ 1.880	377 @ 1.280	1.230	370	26120	794	795	4696, 4697, 4698	4754	Bottom	1.445	1.000	Top	1.185	.731	160 @ 1.800	420 @ 1.150	1.100	400	26056	785	703, 705	4696, 4697, 4704	4757	Bottom	1.454	1.000	Top	1.185	.731	150 @ 2.000	375 @ 1.250	1.130	300	26095	785	703, 705	4702, 4711	4757	Bottom	1.589	1.135	Top	1.204	.731	150 @ 1.925	410 @ 1.275	1.225
Top	.943	.580	90 @ 1.470	252 @ .970	.900	324	26523¹	798	799	N/A	N/A																																																																																																																																																																											
Bottom	1.105	.742										Top	.959	.636	93 @ 1.570	198 @ 1.020	.952	191	26113	702, 791	700, 792	N/A	N/A	Bottom	1.061	.738	Top	1.013	.650	120 @ 1.640	275 @ 1.040	.970	258	26125	702	700	N/A	N/A	Bottom	1.101	.738	Top	1.055	.650	105 @ 1.800	293 @ 1.200	1.100	313	26915	762, 772, 788	761, 774, 783, 787	4705	4753	Bottom	1.290	.885	Top	1.065	.650	110 @ 1.700	292 @ 1.175	1.115	347	26981	788	787, 795	4693	4753	Bottom	1.240	.825	Top	1.065	.650	109 @ 1.800	284 @ 1.175	1.060	280	26986	788	787, 795	4696	4755	Bottom	1.415	1.000	Top	1.065	.650	137 @ 1.700	305 @ 1.100	1.060	280	26995	788	787, 795	4696	4755	Bottom	1.415	1.000	Top	1.075	.650	125 @ 1.800	367 @ 1.150	1.100	372	26918¹	762, 772, 788	761, 774, 783, 787, 795	4705	4753	Bottom	1.310	.885	Top	1.095	.650	155 @ 1.880	377 @ 1.280	1.230	370	26120	794	795	4696, 4697, 4698	4754	Bottom	1.445	1.000	Top	1.185	.731	160 @ 1.800	420 @ 1.150	1.100	400	26056	785	703, 705	4696, 4697, 4704	4757	Bottom	1.454	1.000	Top	1.185	.731	150 @ 2.000	375 @ 1.250	1.130	300	26095	785	703, 705	4702, 4711	4757	Bottom	1.589	1.135	Top	1.204	.731	150 @ 1.925	410 @ 1.275	1.225	400	26055	785	703, 705	4702, 4711	4757	Bottom	1.585	1.112						
Top	.959	.636	93 @ 1.570	198 @ 1.020	.952	191	26113	702, 791	700, 792	N/A	N/A																																																																																																																																																																											
Bottom	1.061	.738										Top	1.013	.650	120 @ 1.640	275 @ 1.040	.970	258	26125	702	700	N/A	N/A	Bottom	1.101	.738	Top	1.055	.650	105 @ 1.800	293 @ 1.200	1.100	313	26915	762, 772, 788	761, 774, 783, 787	4705	4753	Bottom	1.290	.885	Top	1.065	.650	110 @ 1.700	292 @ 1.175	1.115	347	26981	788	787, 795	4693	4753	Bottom	1.240	.825	Top	1.065	.650	109 @ 1.800	284 @ 1.175	1.060	280	26986	788	787, 795	4696	4755	Bottom	1.415	1.000	Top	1.065	.650	137 @ 1.700	305 @ 1.100	1.060	280	26995	788	787, 795	4696	4755	Bottom	1.415	1.000	Top	1.075	.650	125 @ 1.800	367 @ 1.150	1.100	372	26918¹	762, 772, 788	761, 774, 783, 787, 795	4705	4753	Bottom	1.310	.885	Top	1.095	.650	155 @ 1.880	377 @ 1.280	1.230	370	26120	794	795	4696, 4697, 4698	4754	Bottom	1.445	1.000	Top	1.185	.731	160 @ 1.800	420 @ 1.150	1.100	400	26056	785	703, 705	4696, 4697, 4704	4757	Bottom	1.454	1.000	Top	1.185	.731	150 @ 2.000	375 @ 1.250	1.130	300	26095	785	703, 705	4702, 4711	4757	Bottom	1.589	1.135	Top	1.204	.731	150 @ 1.925	410 @ 1.275	1.225	400	26055	785	703, 705	4702, 4711	4757	Bottom	1.585	1.112																					
Top	1.013	.650	120 @ 1.640	275 @ 1.040	.970	258	26125	702	700	N/A	N/A																																																																																																																																																																											
Bottom	1.101	.738										Top	1.055	.650	105 @ 1.800	293 @ 1.200	1.100	313	26915	762, 772, 788	761, 774, 783, 787	4705	4753	Bottom	1.290	.885	Top	1.065	.650	110 @ 1.700	292 @ 1.175	1.115	347	26981	788	787, 795	4693	4753	Bottom	1.240	.825	Top	1.065	.650	109 @ 1.800	284 @ 1.175	1.060	280	26986	788	787, 795	4696	4755	Bottom	1.415	1.000	Top	1.065	.650	137 @ 1.700	305 @ 1.100	1.060	280	26995	788	787, 795	4696	4755	Bottom	1.415	1.000	Top	1.075	.650	125 @ 1.800	367 @ 1.150	1.100	372	26918¹	762, 772, 788	761, 774, 783, 787, 795	4705	4753	Bottom	1.310	.885	Top	1.095	.650	155 @ 1.880	377 @ 1.280	1.230	370	26120	794	795	4696, 4697, 4698	4754	Bottom	1.445	1.000	Top	1.185	.731	160 @ 1.800	420 @ 1.150	1.100	400	26056	785	703, 705	4696, 4697, 4704	4757	Bottom	1.454	1.000	Top	1.185	.731	150 @ 2.000	375 @ 1.250	1.130	300	26095	785	703, 705	4702, 4711	4757	Bottom	1.589	1.135	Top	1.204	.731	150 @ 1.925	410 @ 1.275	1.225	400	26055	785	703, 705	4702, 4711	4757	Bottom	1.585	1.112																																				
Top	1.055	.650	105 @ 1.800	293 @ 1.200	1.100	313	26915	762, 772, 788	761, 774, 783, 787	4705	4753																																																																																																																																																																											
Bottom	1.290	.885										Top	1.065	.650	110 @ 1.700	292 @ 1.175	1.115	347	26981	788	787, 795	4693	4753	Bottom	1.240	.825	Top	1.065	.650	109 @ 1.800	284 @ 1.175	1.060	280	26986	788	787, 795	4696	4755	Bottom	1.415	1.000	Top	1.065	.650	137 @ 1.700	305 @ 1.100	1.060	280	26995	788	787, 795	4696	4755	Bottom	1.415	1.000	Top	1.075	.650	125 @ 1.800	367 @ 1.150	1.100	372	26918¹	762, 772, 788	761, 774, 783, 787, 795	4705	4753	Bottom	1.310	.885	Top	1.095	.650	155 @ 1.880	377 @ 1.280	1.230	370	26120	794	795	4696, 4697, 4698	4754	Bottom	1.445	1.000	Top	1.185	.731	160 @ 1.800	420 @ 1.150	1.100	400	26056	785	703, 705	4696, 4697, 4704	4757	Bottom	1.454	1.000	Top	1.185	.731	150 @ 2.000	375 @ 1.250	1.130	300	26095	785	703, 705	4702, 4711	4757	Bottom	1.589	1.135	Top	1.204	.731	150 @ 1.925	410 @ 1.275	1.225	400	26055	785	703, 705	4702, 4711	4757	Bottom	1.585	1.112																																																			
Top	1.065	.650	110 @ 1.700	292 @ 1.175	1.115	347	26981	788	787, 795	4693	4753																																																																																																																																																																											
Bottom	1.240	.825										Top	1.065	.650	109 @ 1.800	284 @ 1.175	1.060	280	26986	788	787, 795	4696	4755	Bottom	1.415	1.000	Top	1.065	.650	137 @ 1.700	305 @ 1.100	1.060	280	26995	788	787, 795	4696	4755	Bottom	1.415	1.000	Top	1.075	.650	125 @ 1.800	367 @ 1.150	1.100	372	26918¹	762, 772, 788	761, 774, 783, 787, 795	4705	4753	Bottom	1.310	.885	Top	1.095	.650	155 @ 1.880	377 @ 1.280	1.230	370	26120	794	795	4696, 4697, 4698	4754	Bottom	1.445	1.000	Top	1.185	.731	160 @ 1.800	420 @ 1.150	1.100	400	26056	785	703, 705	4696, 4697, 4704	4757	Bottom	1.454	1.000	Top	1.185	.731	150 @ 2.000	375 @ 1.250	1.130	300	26095	785	703, 705	4702, 4711	4757	Bottom	1.589	1.135	Top	1.204	.731	150 @ 1.925	410 @ 1.275	1.225	400	26055	785	703, 705	4702, 4711	4757	Bottom	1.585	1.112																																																																		
Top	1.065	.650	109 @ 1.800	284 @ 1.175	1.060	280	26986	788	787, 795	4696	4755																																																																																																																																																																											
Bottom	1.415	1.000										Top	1.065	.650	137 @ 1.700	305 @ 1.100	1.060	280	26995	788	787, 795	4696	4755	Bottom	1.415	1.000	Top	1.075	.650	125 @ 1.800	367 @ 1.150	1.100	372	26918¹	762, 772, 788	761, 774, 783, 787, 795	4705	4753	Bottom	1.310	.885	Top	1.095	.650	155 @ 1.880	377 @ 1.280	1.230	370	26120	794	795	4696, 4697, 4698	4754	Bottom	1.445	1.000	Top	1.185	.731	160 @ 1.800	420 @ 1.150	1.100	400	26056	785	703, 705	4696, 4697, 4704	4757	Bottom	1.454	1.000	Top	1.185	.731	150 @ 2.000	375 @ 1.250	1.130	300	26095	785	703, 705	4702, 4711	4757	Bottom	1.589	1.135	Top	1.204	.731	150 @ 1.925	410 @ 1.275	1.225	400	26055	785	703, 705	4702, 4711	4757	Bottom	1.585	1.112																																																																																	
Top	1.065	.650	137 @ 1.700	305 @ 1.100	1.060	280	26995	788	787, 795	4696	4755																																																																																																																																																																											
Bottom	1.415	1.000										Top	1.075	.650	125 @ 1.800	367 @ 1.150	1.100	372	26918¹	762, 772, 788	761, 774, 783, 787, 795	4705	4753	Bottom	1.310	.885	Top	1.095	.650	155 @ 1.880	377 @ 1.280	1.230	370	26120	794	795	4696, 4697, 4698	4754	Bottom	1.445	1.000	Top	1.185	.731	160 @ 1.800	420 @ 1.150	1.100	400	26056	785	703, 705	4696, 4697, 4704	4757	Bottom	1.454	1.000	Top	1.185	.731	150 @ 2.000	375 @ 1.250	1.130	300	26095	785	703, 705	4702, 4711	4757	Bottom	1.589	1.135	Top	1.204	.731	150 @ 1.925	410 @ 1.275	1.225	400	26055	785	703, 705	4702, 4711	4757	Bottom	1.585	1.112																																																																																																
Top	1.075	.650	125 @ 1.800	367 @ 1.150	1.100	372	26918¹	762, 772, 788	761, 774, 783, 787, 795	4705	4753																																																																																																																																																																											
Bottom	1.310	.885										Top	1.095	.650	155 @ 1.880	377 @ 1.280	1.230	370	26120	794	795	4696, 4697, 4698	4754	Bottom	1.445	1.000	Top	1.185	.731	160 @ 1.800	420 @ 1.150	1.100	400	26056	785	703, 705	4696, 4697, 4704	4757	Bottom	1.454	1.000	Top	1.185	.731	150 @ 2.000	375 @ 1.250	1.130	300	26095	785	703, 705	4702, 4711	4757	Bottom	1.589	1.135	Top	1.204	.731	150 @ 1.925	410 @ 1.275	1.225	400	26055	785	703, 705	4702, 4711	4757	Bottom	1.585	1.112																																																																																																															
Top	1.095	.650	155 @ 1.880	377 @ 1.280	1.230	370	26120	794	795	4696, 4697, 4698	4754																																																																																																																																																																											
Bottom	1.445	1.000										Top	1.185	.731	160 @ 1.800	420 @ 1.150	1.100	400	26056	785	703, 705	4696, 4697, 4704	4757	Bottom	1.454	1.000	Top	1.185	.731	150 @ 2.000	375 @ 1.250	1.130	300	26095	785	703, 705	4702, 4711	4757	Bottom	1.589	1.135	Top	1.204	.731	150 @ 1.925	410 @ 1.275	1.225	400	26055	785	703, 705	4702, 4711	4757	Bottom	1.585	1.112																																																																																																																														
Top	1.185	.731	160 @ 1.800	420 @ 1.150	1.100	400	26056	785	703, 705	4696, 4697, 4704	4757																																																																																																																																																																											
Bottom	1.454	1.000										Top	1.185	.731	150 @ 2.000	375 @ 1.250	1.130	300	26095	785	703, 705	4702, 4711	4757	Bottom	1.589	1.135	Top	1.204	.731	150 @ 1.925	410 @ 1.275	1.225	400	26055	785	703, 705	4702, 4711	4757	Bottom	1.585	1.112																																																																																																																																													
Top	1.185	.731	150 @ 2.000	375 @ 1.250	1.130	300	26095	785	703, 705	4702, 4711	4757																																																																																																																																																																											
Bottom	1.589	1.135										Top	1.204	.731	150 @ 1.925	410 @ 1.275	1.225	400	26055	785	703, 705	4702, 4711	4757	Bottom	1.585	1.112																																																																																																																																																												
Top	1.204	.731	150 @ 1.925	410 @ 1.275	1.225	400	26055	785	703, 705	4702, 4711	4757																																																																																																																																																																											
Bottom	1.585	1.112																																																																																																																																																																																				

¹ Super Finish – surface enhancement that increases life and load loss

SINGLE OUTER VALVE SPRINGS

O.D. DIA. 1	I.D. DIA. 2	DAMPER	SEAT LOAD	OPEN LOAD	COIL BIND	RATE (LBS./IN.)	PART #	TITANIUM RETAINER	STEEL RETAINER	LOCATOR	SHIMS
.896	.600	N	50 @ 1.950	170 @ 1.450	1.360	240	912	753	N/A	N/A	N/A
1.159	.836	N	75 @ 1.550	195 @ 1.050	.917	240	909	N/A	N/A	N/A	N/A
1.230	.876	Y	92 @ 1.700	230 @ 1.250	1.150	308	980	728	742, 750	N/A	4753
1.254	.880	Y	105 @ 1.700	273 @ 1.250	1.150	373	981	728	742, 750	N/A	4753
1.269	.711	Y	130 @ 1.750	391 @ 1.175	1.100	454	941	728	750	N/A	4753
1.320	.920	N	103 @ 1.780	325 @ 1.160	1.100	356	26975¹	N/A	N/A	N/A	N/A
1.354	.930	Y	94 @ 1.850	323 @ 1.350	1.280	458	910	N/A	N/A	N/A	N/A
1.355	1.000	N	48 @ 1.600	146 @ 1.250	1.125	280	902	N/A	N/A	N/A	4754
1.355	1.011	N	61 @ 1.600	137 @ 1.250	1.054	219	906	N/A	N/A	N/A	4754
1.390	.990	Y	77 @ 1.800	234 @ 1.300	1.260	313	961	N/A	N/A	N/A	N/A
1.400	1.015	N	80 @ 1.700	212 @ 1.250	1.125	293	903	N/A	N/A	N/A	4754
1.406	1.020	N	80 @ 1.700	180 @ 1.300	1.203	251	970	N/A	N/A	N/A	N/A
1.430	1.070	Y	105 @ 1.750	215 @ 1.250	1.150	231	984	730	740, 743, 744	N/A	4754
1.437	1.027	Y	115 @ 1.700	284 @ 1.200	1.125	339	942	730	747, 768	N/A	4754
1.437	1.063	Y	113 @ 1.500	207 @ 1.150	.950	269	990	730	740, 743, 744	N/A	4754
1.460	1.060	Y	124 @ 1.800	293 @ 1.250	1.195	308	972	730	740, 743, 744	4704	4755
1.464	1.070	Y	93 @ 1.900	237 @ 1.300	1.200	241	940	730	740	4704	4755
1.476	1.062	Y	109 @ 1.800	317 @ 1.300	1.140	415	926	730	740	4704	4755
1.494	1.080	Y	104 @ 1.650	259 @ 1.250	1.100	387	901	730	740, 743, 744	N/A	4754
1.509	1.125	Y	137 @ 1.750	262 @ 1.250	1.175	251	920	721, 732	741	4704	4755
1.524	1.110	Y	122 @ 1.900	309 @ 1.400	1.200	373	911	721, 732	741	4779 ²	4757
1.539	1.125	Y	149 @ 1.900	328 @ 1.350	1.225	325	936	721, 732	741	4700	4757

¹Works with GM 604 circle track crate engines²Rotator Eliminator

SINGLE INNER VALVE SPRINGS

O.D. DIA. 1	I.D. DIA. 2	SEAT LOAD	OPEN LOAD	COIL BIND	RATE (LBS./IN.)	PART #
.937	.697	27 @ 1.650	70 @ 1.200	.920	96	974
.953	.697	58 @ 1.500	110 @ 1.100	.928	130	975
.970	.700	46 @ 1.750	126 @ 1.150	1.040	134	973
1.015	.731	54 @ 1.800	147 @ 1.200	1.100	156	937

OVATE WIRE VALVE SPRINGS

Ovate wire springs (constructed from oval shaped wire as opposed to round) have more material occupying the same area than round wire springs to more efficiently distribute the operation stresses.

O.D. DIA. 1	I.D. DIA. 2	SEAT LOAD	OPEN LOAD	COIL BIND	RATE (LBS./IN.)	PART #	TITANIUM RETAINER	STEEL RETAINER	LOCATOR	SHIMS
1.260	.836	105 @ 1.700	310 @ 1.200	1.150	410	983	N/A	751	N/A	N/A

OVATE WIRE VALVE SPRING KIT

Includes Part #983 springs, #751 retainers and #613 locks.

983-KIT

CONICAL VALVE SPRINGS

Conical valve springs have a unique cone shape. They were specifically designed for Small Block Chevrolets with up to .500" lift but require no machining to the spring pockets.

	O.D. DIA. 1	I.D. DIA. 2	SEAT LOAD	OPEN LOAD	COIL BIND	RATE (LBS./IN.)	PART #	TITANIUM RETAINER	STEEL RETAINER	LOCATOR	SHIMS
Top	1.454	1.070	100 @ 1.750	281 @ 1.250	1.135	362	982	730	740, 743	N/A	4754
Bottom	1.250	.866									

CONICAL VALVE SPRING KIT

Includes Part #982 springs, #743 steel retainers, #601 locks and #502 seals.

982-KIT

DUAL VALVE SPRINGS

O.D. OF OUTER DIA. 1	I.D. OF OUTER DIA. 1	I.D. OF INNER DIA. 2	DAMPER	SEAT LOAD	OPEN LOAD	COIL BIND	RATE (LBS./IN.)	PART #	TITANIUM RETAINER	STEEL RETAINER	LOCATOR	SHIMS
1.300	.895	.655	N	135 @ 1.770	400 @ 1.120	1.040	408	26921	754	N/A	4695	4753
1.320	.920	.654	N	129 @ 1.835	470 @ 1.160	1.100	505	26926	779	1777, 1779	4695	4753
1.320	.920	.654	N	129 @ 1.835	470 @ 1.160	1.100	505	26526¹	779	1777, 1779	4695	4753
1.320	.958	.680	N	141 @ 1.810	405 @ 1.150	1.100	400	26925	717	1777, 1779	4695	4753
1.384	1.060	.804	N	117 @ 1.600	232 @ 1.100	1.000	230	988	730	740, 743, 744	N/A	4754
1.430	1.070	.697	Y	121 @ 1.750	343 @ 1.200	1.150	370	987	730	740	N/A	4754
1.430	1.070	.697	Y	132 @ 1.750	293 @ 1.250	1.150	322	986	730	740	N/A	4754
1.430	1.070	.700	Y	165 @ 1.750	346 @ 1.250	1.150	366	985	730	740	N/A	4754
1.437	1.073	.697	Y	102 @ 1.700	303 @ 1.150	1.065	367	994	730	740	N/A	4754
1.437	1.073	.697	Y	115 @ 1.700	336 @ 1.150	1.020	402	995	730	740	N/A	4754
1.460	1.060	.697	Y	127 @ 1.850	369 @ 1.250	1.195	403	978	730	740	4704	4755
1.460	1.060	.700	Y	155 @ 1.850	420 @ 1.250	1.195	441	977	730	740	4704	4755
1.475	1.080	.712	Y	133 @ 1.900	332 @ 1.300	1.200	332	950	730	740, 743, 744	4781, 4782, 4704	4755
1.489	1.105	.819	N	165 @ 1.800	385 @ 1.200	1.100	367	914	731, 720	741	4704, 4776, 4777	4755
1.500	1.050	.719	N	325 @ 2.100	1045 @ 1.200	1.130	800	26956	718	1718	4796, 4784	4755
1.500	1.050	.719	N	405 @ 2.150	1166 @ 1.200	1.130	788	26957	718	1718	4796, 4784	4755
1.500	1.050	.719	N	445 @ 2.175	1245 @ 1.175	1.130	830	26955	718	1718	4796, 4784	4755
1.509	1.125	.697	Y	111 @ 1.900	388 @ 1.200	1.175	395	925	732, 721	741	4700, 4771, 4783	4757
1.509	1.125	.697	Y	112 @ 1.900	355 @ 1.200	1.175	347	924	732, 721	741	4700, 4770	4757
1.535	1.135	.754	Y	148 @ 1.880	432 @ 1.230	1.160	437	954	732, 721	741	4700, 4781, 4782	4757
1.536	1.111	.730	Y	210 @ 1.900	524 @ 1.250	1.170	483	929	732, 721	741	4700, 4772, 4773	4757
1.539	1.125	.697	Y	138 @ 1.950	419 @ 1.350	1.225	469	939	N/A	741	4700, 4770, 4771, 4783	4757
1.539	1.125	.731	Y	195 @ 2.000	563 @ 1.250	1.135	502	26097	732, 721	N/A	4700, 4778, 4780	4757
1.539	1.125	.731	Y	197 @ 1.950	545 @ 1.250	1.175	498	927	732, 721	N/A	4700, 4778, 4780	4757
1.539	1.125	.731	Y	204 @ 1.900	516 @ 1.250	1.225	480	938	738	741	4700, 4778, 4780	4757
1.539	1.137	.747	Y	148 @ 1.900	456 @ 1.250	1.085	473	953	732	741	4700, 4772	4757
1.540	1.126	.814	N	194 @ 1.950	579 @ 1.250	1.100	550	919	731, 720	741	4700, 4785	4757
1.549	1.125	.719	Y	225 @ 2.050	633 @ 1.300	1.192	544	26115	732	748	4700, 4781, 4782	4757
1.550	1.114	.724	Y	215 @ 1.900	690 @ 1.150	1.090	633	999	732, 721	N/A	4700, 4781, 4782	4757
1.550	1.136	.730	Y	171 @ 1.950	492 @ 1.300	1.200	494	933	732, 721	741	4700, 4781, 4782	4757
1.550	1.136	.752	Y	178 @ 1.900	459 @ 1.275	1.200	449	26094	732, 721	749	4700, 4772, 4773	4757
1.550	1.136	.812	N	230 @ 2.000	580 @ 1.300	1.230	500	26089	731, 720	N/A	4700, 4777, 4785	4757
1.550	1.136	.812	N	240 @ 1.900	598 @ 1.250	1.160	551	943	731, 720	749	4700, 4785, 4777	4757
1.550	1.136	.812	N	240 @ 2.000	608 @ 1.300	1.230	526	955	731, 720	749	4700, 4785, 4777	4757
1.550	1.136	.824	N	200 @ 1.800	596 @ 1.100	1.050	566	917	731, 720	741	4700, 4785	4757
1.550	1.150	.795	Y	153 @ 1.900	383 @ 1.250	1.160	354	930	732, 721	741	4700, 4776, 4777	4757

COMPONENTS VALVE SPRINGS

¹ Super Finish - surface enhancement that increases life and load loss

DUAL VALVE SPRINGS *(continued)*

O.D. OF OUTER DIA. 1	I.D. OF OUTER DIA. 1	I.D. OF INNER DIA. 2	DAMPER	SEAT LOAD	OPEN LOAD	COIL BIND	RATE (LBS./IN.)	PART #	TITANIUM RETAINER	STEEL RETAINER	LOCATOR	SHIMS
1.550	1.150	.795	Y	160 @ 1.880	383 @ 1.250	1.160	354	928	732, 721	741	4700, 4776, 4777	4757
1.550	1.166	.896	N	200 @ 1.700	474 @ 1.000	.900	392	916	731, 720	741	4700	4757
1.554	1.140	.746	Y	194 @ 1.950	524 @ 1.250	1.180	471	935	724	748	4700, 4772, 4773	4757
1.557	1.143	.749	Y	196 @ 2.000	513 @ 1.300	1.160	452	932	738	748	4700, 4772, 4773	4757
1.570	1.120	.796	N	190 @ 1.950	747 @ 1.200	1.100	743	944	731, 720	N/A	4704, 4776, 4777	4757
1.620	1.170	.846	N	230 @ 1.950	710 @ 1.200	1.100	640	951	736	N/A	4702	4756
1.625	1.175	.769	Y	250 @ 2.050	672 @ 1.250	1.184	563	26099	733	N/A	4702, 4774, 4775	4757
1.625	1.175	.769	Y	250 @ 1.900	724 @ 1.200	1.090	677	998	733	N/A	4702, 4774, 4775	4756
1.625	1.175	.769	Y	275 @ 2.000	816 @ 1.150	1.100	637	996	733	N/A	4702, 4774, 4775	4756
1.645	1.195	.871	N	236 @ 2.000	671 @ 1.250	1.130	580	991	733	N/A	4702, 4774, 4775	4756
1.650	1.190	.772	Y	214 @ 1.950	662 @ 1.250	1.125	640	959	739	N/A	4702	4756

TRIPLE VALVE SPRINGS

O.D. OF OUTER DIA. 1	I.D. OF OUTER DIA. 2	I.D. OF MIDDLE DIA. 3	I.D. OF INNER DIA. 4	SEAT LOAD	OPEN LOAD	COIL BIND	RATE (LBS./IN.)	PART #	TITANIUM RETAINER	LOCATOR	SHIMS
1.645	1.195	.871	.635	250 @ 2.050	800 @ 1.250	1.130	688	946	722, 735, 739	4702	4756
1.645	1.195	.871	.635	332 @ 2.100	950 @ 1.200	1.130	687	948	722, 735, 739	4702	4756
1.645	1.195	.871	.635	338 @ 2.000	849 @ 1.250	1.145	681	947	722, 735, 739	4702	4756
1.680	1.195	.871	.635	382 @ 2.100	1067 @ 1.200	1.130	761	26082	722, 735, 739	4708	4756
1.686	1.195	.872	.634	342 @ 2.200	1054 @ 1.200	1.161	712	26028	722, 735, 739	4708	4756

Note: Spring pressures may vary +/- 10%, available as singles or in sets of 8, 12 or 16

Note: Special seals available to fit these springs (see p. 311), use #735 retainers for +.050" installed height

HONDA/ACURA DOHC VALVE SPRING KITS

O.D. OF OUTER DIA. 1	I.D. OF OUTER DIA. 2	I.D. OF INNER DIA. 3	SEAT LOAD	OPEN LOAD	COIL BIND	RATE (LBS./IN.)	INCLUDES	PART #
.896	.600	N/A	50 @ 1.950	170 @ 1.450	1.360	240	Intake and Exhaust Springs & #753 Titanium Ret.	89001-KIT
1.171	.875	.615	23 @ 1.500	178 @ .975	.858	296	Intake and Exhaust Springs & #778 Steel Ret.	89000-KIT
1.171	.875	.615	23 @ 1.500	178 @ .975	.858	296	Intake and Exhaust Springs & #760 Titanium Ret.	89012-KIT
1.171	.875	Int. - .615	Int. - 60 @ 1.375" Ex. - 43 @ 1.375"	Int. - 222 @ .875" Ex. - 148 @ .875"	.858	296	Dual Intake and Single Exhaust Springs	913-SET

DUAL

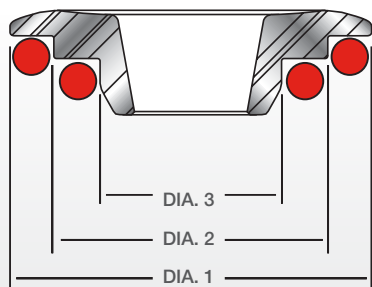

TRIPLE

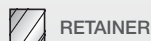
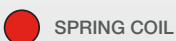
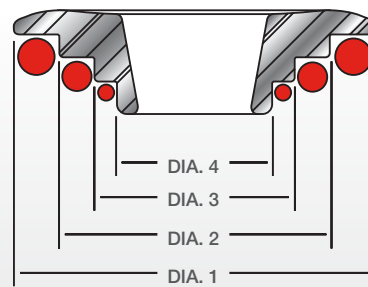

PART #	26123	26523	913	975	990	909	902	906	988
# of Springs	Beehive™	Beehive™	Double	Single	Single	Single	Single	Single	Double
Installed Height	1.470	1.470	1.475	1.500	1.500	1.550	1.600	1.600	1.600
O.D. of Outer	.943/1.105	.943/1.105	1.171	.953	1.437	1.159	1.355	1.355	1.384
I.D. of Outer	.580/.742	.580/.742	.875	.697	1.063	.836	1.000	1.011	1.060
I.D. of Inner	N/A	N/A	.615	N/A	N/A	N/A	N/A	N/A	.804
Spring Rate	324	324	296	130	269	240	280	219	230
Damper	No	No	No	No	Yes	No	No	No	No
SPRING HEIGHT (INCHES)					SPRING LOADS (LBS.)				
2.300									
2.250									
2.200									
2.150									
2.100									
2.050									
2.000									
1.950									
1.900									
1.850									
1.800									
1.750									
1.700									
1.650							34	50	105
1.600						63	48	61	117
1.550	64	64		48	100	75	62	72	128
1.500	80	80	23	58	113	87	76	82	140
1.450	96	96	38	62	127	99	90	93	151
1.400	113	113	53	69	140	111	104	104	163
1.350	129	129	67	77	154	123	118	115	174
1.300	145	145	82	84	167	135	132	126	186
1.250	161	161	97	91	181	147	146	137	197
1.200	177	177	112	98	194	159	160	148	209
1.150	194	194	127	105	207	171		158	220
1.100	210	210	141	110	221	183		169	232
1.050	226	226	156	120	234	195			243
1.000	242	242	171	127	248	207			
0.950			186						
0.900			201						
0.850									
Maximum Coil Bind Height	0.900	0.900	0.858	0.928	0.950	0.917	1.125	1.054	1.000
Ti. Ret. (Std. Weight)	798	798	760		730				730
Ti. Ret. (Light Weight)									
Steel Ret. (Std. Weight)	799	799			740 743 744				740 743 744
Steel Ret. (Light Weight)					1730				1730
Seat 0.570 Guide Diameter									
Seat 0.630 Guide Diameter									
Spring Cup (O.D. Locator)									
Shims					4754		4754	4754	4754



PART #	26113	26125	974	901	26981	26995	980	981	983	
# of Springs	Beehive™	Beehive	Single	Single	Beehive™	Beehive™	Single	Single	Single	
Installed Height	1.640	1.640	1.650	1.650	1.700	1.700	1.700	1.700	1.700	
O.D. of Outer	0.959/1.061	1.013/1.101	.937	1.494	1.065/1.240	1.065/1.415	1.230	1.254	1.260	
I.D. of Outer	.636/.738	0.650/ 0.738	.697	1.080	.650/.825	.650/1.000	.876	.880	.836	
I.D. of Inner	N/A	n/a	N/A	N/A	N/A	N/A	N/A	N/A	N/A	
Spring Rate	191	258	96	387	347	280	308	373	410	
Damper	No	No	No	Yes	No	No	Yes	Yes	No	
SPRING HEIGHT (INCHES)					SPRING LOADS (LBS.)					
2.300										
2.250										
2.200										
2.150										
2.100										
2.050										
2.000										
1.950										
1.900										
1.850										
1.800										
1.750					93	123	77	87	85	
1.700		104	22	83	110	137	92	105	105	
1.650	78	117	27	104	127	151	107	123	126	
1.600	88	130	32	119	145	165	123	142	146	
1.550	97	143	37	136	162	179	138	160	167	
1.500	107	156	41	154	179	193	153	178	187	
1.450	116	169	46	172	197	207	169	197	208	
1.400	126	182	51	189	214	221	184	215	228	
1.350	135	194	56	207	231	235	200	233	249	
1.300	145	207	61	225	249	249	215	252	269	
1.250	154	220	65	259	266	263	230	273	290	
1.200	164	233	70	260	283	277		294	310	
1.150	174	246	75		301	291				
1.100	183	259	80			305				
1.050	193	272	85			320				
1.000	202	285	89							
0.950										
0.900										
0.850										
Maximum Coil Bind Height	0.952	0.97	0.920	1.100	1.115	1.060	1.150	1.150	1.150	
Ti. Ret. (Std. Weight)				730			728	728		
Ti. Ret. (Light Weight)	791 702	791 702			788	788				
Steel Ret. (Std. Weight)	792 700	700		740 743 744	787 795	787 795	742 750	742 750	751	
Steel Ret. (Light Weight)	1723	1723		1730		1787	1750	1750		
Seat 0.570 Guide Diameter					4693	4696				
Seat 0.630 Guide Diameter										
Spring Cup (O.D. Locator)										
Shims				4754	4753	4755	4753	4753		

903	970	942	994	995	916	973	982	941	PART #
Single	Single	Single	Double	Double	Double	Single	Conical	Single	# of Springs
1.700	1.700	1.700	1.700	1.700	1.700	1.750	1.750	1.750	Installed Height
1.400	1.406	1.437	1.437	1.437	1.550	.970	1.250/1.454	1.269	O.D. of Outer
1.015	1.020	1.027	1.073	1.073	1.166	.700	.866/1.070	.711	I.D. of Outer
N/A	N/A	N/A	.697	.697	.896	N/A	N/A	N/A	I.D. of Inner
293	251	339	367	402	392	134	362	454	Spring Rate
No	No	Yes	Yes	Yes	No	No	No	Yes	Damper
SPRING LOADS (LBS.)									SPRING HEIGHT (INCHES)
									2.300
									2.250
									2.200
									2.150
									2.100
									2.050
									2.000
									1.950
									1.900
									1.850
						39	82	107	1.800
65	67	98	84	95	180	46	100	130	1.750
80	80	115	102	115	200	53	118	153	1.700
95	92	132	120	135	220	59	136	175	1.650
109	105	149	139	155	239	66	154	198	1.600
124	118	165	157	175	259	73	172	221	1.550
139	130	182	175	195	278	80	191	244	1.500
153	143	199	194	216	298	86	209	266	1.450
168	155	216	212	236	318	93	227	289	1.400
182	168	233	230	256	337	100	245	312	1.350
197	180	250	249	276	357	106	263	334	1.300
212	193	267	267	296	376	113	281	358	1.250
226		284	286	316	396	120	299	381	1.200
			303	336	416	126		403	1.150
			321	356	435	133			1.100
			340		455	140			1.050
					474				1.000
					494				0.950
									0.900
									0.850
1.125	1.203	1.125	1.065	1.020	0.900	1.040	1.135	1.100	Maximum Coil Bind Height
		730	730	730	731		730	728	Ti. Ret. (Std. Weight)
					720				Ti. Ret. (Light Weight)
		768 747	740	740	741		743 740	750	Steel Ret. (Std. Weight)
		1730	1730	1730	1731		1730	1750	Steel Ret. (Light Weight)
									Seat 0.570 Guide Diameter
									Seat 0.630 Guide Diameter
					4700				Spring Cup (O.D. Locator)
4754		4754	4754	4754	4757		4754	4753	Shims



PART #	985	920	26921	26975 ¹	937	26915	26986	26918	26056
# of Springs	Double	Single	Double	Single	Single Inner	Beehive™	Beehive™	Beehive™	Beehive™
Installed Height	1.750	1.750	1.770	1.780	1.800	1.800	1.800	1.800	1.800
O.D. of Outer	1.430	1.509	1.300	1.320	1.015	1.055/1.290	1.065/1.415	1.075/1.310	1.185/1.454
I.D. of Outer	1.070	1.125	.895	.920	.731	.650/.885	.650/1.000	.650/.885	.731/1.000
I.D. of Inner	.700	N/A	.655	N/A	N/A	N/A	N/A	N/A	N/A
Spring Rate	366	251	408	356	156	313	280	372	400
Damper	Yes	Yes	No	No	No	No	No	No	No
SPRING HEIGHT (INCHES)					SPRING LOADS (LBS.)				
2.300									
2.250									
2.200									
2.150									
2.100									
2.050									
2.000									
1.950									
1.900									120
1.850					46	89	95	106	140
1.800	146	124	123	96	54	105	109	125	160
1.750	165	137	143	114	62	121	123	144	180
1.700	181	149	164	132	69	136	137	162	200
1.650	199	162	184	150	77	152	151	181	220
1.600	217	174	204	168	85	168	165	199	240
1.550	236	187	225	186	93	183	179	218	260
1.500	254	199	245	204	101	199	193	237	280
1.450	272	212	265	222	108	215	207	255	300
1.400	291	224	286	239	116	230	221	274	320
1.350	309	237	306	257	124	246	235	293	340
1.300	327	250	327	275	132	262	249	311	360
1.250	346	262	347	293	139	277	263	330	380
1.200	364		367	311	147	293	277	348	400
1.150			388	329	155		291	367	420
1.100			408				305		
1.050									
1.000									
0.950									
0.900									
0.850									
Maximum Coil Bind Height	1.150	1.175	1.040	1.100	1.100	1.100	1.060	1.100	1.100
Ti. Ret. (Std. Weight)	730	732		779					785
Ti. Ret. (Light Weight)		721	754			772 762 788	788	772 762 788	
Steel Ret. (Std. Weight)	740	741				774 783 761 787	787 795	774 783 761 787	703 705
Steel Ret. (Light Weight)	1730	1731	1754	1777, 1779		1772 1787	1787	1772 1787	
Seat 0.570 Guide Diameter						4705	4696	4705	4696
Seat 0.630 Guide Diameter									4697
Spring Cup (O.D. Locator)		4704	4695	4709					4704
Shims	4754	4755	4753	4753		4753	4755	4753	4757

¹ Works with GM 604 circle track crate engines.

961	984	986	987	972	926	914	917	26925	PART #
Single	Single	Double	Double	Single	Single	Double	Double	Double	# of Springs
1.800	1.800	1.800	1.800	1.800	1.800	1.800	1.800	1.810	Installed Height
1.390	1.430	1.430	1.430	1.460	1.476	1.489	1.550	1.320	O.D. of Outer
.990	1.070	1.070	1.070	1.060	1.062	1.105	1.136	0.958	I.D. of Outer
N/A	N/A	.697	.697	N/A	N/A	.819	.824	0.680	I.D. of Inner
313	231	322	370	308	415	367	566	400	Spring Rate
Yes	Yes	Yes	Yes	Yes	Yes	No	No	No	Damper
SPRING LOADS (LBS.)									SPRING HEIGHT (INCHES)
									2.300
									2.250
									2.200
									2.150
									2.100
									2.050
									2.000
									1.950
									1.900
61	82	103	104	109	88	147	172	125	1.850
77	95	117	121	124	109	165	200	145	1.800
93	105	132	121	139	129	183	228	165	1.750
108	115	147	156	155	150	202	257	185	1.700
124	125	163	174	170	171	220	285	205	1.650
140	135	179	193	185	192	238	313	225	1.600
155	146	196	211	201	213	257	341	245	1.550
171	158	212	230	216	234	275	370	265	1.500
187	169	228	249	231	255	293	398	285	1.450
202	181	244	268	247	276	312	426	305	1.400
218	192	261	286	262	296	330	455	325	1.350
234	204	277	305	277	317	349	483	345	1.300
	215	293	324	293	338	367	511	365	1.250
	232	310	343		359	385	539	385	1.200
						404	568	405	1.150
							596		1.100
									1.050
									1.000
									0.950
									0.900
									0.850
1.260	1.150	1.150	1.150	1.195	1.140	1.100	1.050	1.100	Maximum Coil Bind Height
	730	730	730	730	730	731	731	717	Ti. Ret. (Std. Weight)
						720	720		Ti. Ret. (Light Weight)
	740 743 744	740	740	740 743 744	740	741	741	713,714	Steel Ret. (Std. Weight)
	1730	1730	1730	1730	1730	1731	1731	1717	Steel Ret. (Light Weight)
						4776	4785	4695	Seat 0.570 Guide Diameter
						4777			Seat 0.630 Guide Diameter
				4704	4704	4704	4700		Spring Cup (O.D. Locator)
	4754	4754	4754	4755	4755	4755	4757	4753	Shims



PART #	26926	26526	910	978	977	928	26120	940	950
# of Springs	Double	Double	Single	Double	Double	Double	Beehive™	Single	Double
Installed Height	1.835	1.835	1.850	1.850	1.850	1.850	1.900	1.900	1.900
O.D. of Outer	1.320	1.320	1.354	1.460	1.460	1.550	1.095/1.445	1.464	1.475
I.D. of Outer	.920	.920	.930	1.060	1.060	1.150	.650/1.000	1.070	1.080
I.D. of Inner	.654	.654	N/A	.697	.700	.795	N/A	N/A	.712
Spring Rate	505	505	458	403	441	354	370	241	332
Damper	No	No	Yes	Yes	Yes	Yes	No	Yes	Yes
SPRING HEIGHT (INCHES)					SPRING LOADS (LBS.)				
2.300									
2.250									
2.200									
2.150									
2.100									
2.050									
2.000									
1.950								80	116
1.900			72	107	133	153	148	93	133
1.850	121	121	92	127	155	171	166	105	149
1.800	146	146	113	147	177	188	185	117	166
1.750	171	171	134	167	199	206	203	129	182
1.700	197	197	155	187	222	224	222	141	199
1.650	222	222	175	208	244	242	240	153	216
1.600	247	247	196	228	266	259	259	165	232
1.550	272	272	217	248	288	277	277	177	249
1.500	298	298	238	268	310	295	296	189	266
1.450	323	323	258	288	332	312	314	201	282
1.400	348	348	279	308	354	330	333	213	299
1.350	373	373	323	329	376	348	351	225	316
1.300	399	399		349	398	365	370	237	332
1.250	424	424		369	420	383	388	249	349
1.200	449	449							
1.150	465	465							
1.100									
1.050									
1.000									
0.950									
0.900									
0.850									
Maximum Coil Bind Height	1.100	1.100	1.280	1.195	1.195	1.160	1.230	1.200	1.200
Ti. Ret. (Std. Weight)	779	779		730	730	732		730	730
Ti. Ret. (Light Weight)						721	794		
Steel Ret. (Std. Weight)				740	740	741	795	740	740 743 744
Steel Ret. (Light Weight)	1777, 1779	1777, 1779		1730	1730	1732		1730	1730
Seat 0.570 Guide Diameter	4695	4695				4776	4696		4781
Seat 0.630 Guide Diameter						4777	4697		4782
Spring Cup (O.D. Locator)	4709	4709		4704	4704	4700	4698	4704	4704
Shims	4753	4753		4755	4755	4757	4754	4755	4755



PART #	26094	943	930	998	946	26055	912	939	927
# of Springs	Double	Double	Double	Double	Triple	Beehive™	Single	Double	Double
Installed Height	1.900	1.900	1.900	1.900	1.900	1.925	1.950	1.950	1.950
O.D. of Outer	1.550	1.550	1.550	1.625	1.645	1.204/1.585	.896	1.539	1.539
I.D. of Outer	1.136	1.136	1.150	1.175	1.195	.731/1.112	.600	1.125	1.125
I.D. of Inner	.752	.812	.795	.769	.871/.635	N/A	N/A	.697	.731
Spring Rate	449	551	354	677	688	400	240	469	498
Damper	Yes	No	Yes	Yes	No	No	No	Yes	Yes
SPRING HEIGHT (INCHES)					SPRING LOADS (LBS.)				
2.300									
2.250									
2.200									
2.150									
2.100									
2.050									
2.000						120	38	115	172
1.950	156	212	135	216	319	140	50	138	197
1.900	178	240	153	250	353	160	62	161	222
1.850	200	268	171	284	387	180	74	185	247
1.800	223	295	188	318	422	200	86	208	272
1.750	245	323	206	352	456	220	98	232	297
1.700	268	350	224	385	491	240	110	255	321
1.650	290	378	242	419	525	260	122	279	346
1.600	313	405	259	453	559	280	134	302	371
1.550	335	433	277	487	594	300	146	325	396
1.500	358	460	295	521	628	320	158	349	421
1.450	380	488	312	555	663	340	170	372	446
1.400	403	516	330	588	697	360	182	396	471
1.350	425	543	348	622	732	380		419	496
1.300	447	571	365	656	766	400		443	520
1.250	470	598	383	690	800	420		466	545
1.200	492	626		724	835				
1.150				758	869				
1.100									
1.050									
1.000									
0.950									
0.900									
0.850									
Maximum Coil Bind Height	1.200	1.160	1.160	1.090	1.130	1.225	1.360	1.225	1.175
Ti. Ret. (Std. Weight)	732	731	732	733	739 735		753		732
Ti. Ret. (Light Weight)	721	720	721		722	785			721
Steel Ret. (Std. Weight)	749	749	741			703 705		741	
Steel Ret. (Light Weight)	1732	1731	1732						1732
Seat 0.570 Guide Diameter	4772	4785	4776	4774		4696		4770 4771	4778
Seat 0.630 Guide Diameter	4773	4777	4777	4775		4697		4783	4780
Spring Cup (O.D. Locator)	4700		4700	4702	4702	4702 4711		4700	4700
Shims	4757	4757	4757	4756	4756	4757		4757	4757

919	933	935	944	951	991	26095	26097	26089	PART #
Double	Double	Double	Double	Double	Double	Single	Double	Double	# of Springs
1.950	1.950	1.950	1.950	1.950	1.950	2.000	2.000	2.000	Installed Height
1.540	1.550	1.554	1.570	1.620	1.650	1.186/1.590	1.539	1.550	O.D. of Outer
1.126	1.136	1.140	1.120	1.170	1.190	.731/1.135	1.125	1.136	I.D. of Outer
.814	.730	.746	.796	.846	.772	N/A	.731	.812	I.D. of Inner
550	494	471	743	640	640	300	502	500	Spring Rate
No	Yes	Yes	No	No	Yes	No	Yes	No	Damper
SPRING LOADS (LBS.)									SPRING HEIGHT (INCHES)
									2.300
									2.250
									2.200
									2.150
									2.100
						135	171	205	2.050
166	146	170	153	198	182	150	195	230	2.000
194	171	194	190	230	214	165	220	255	1.950
221	196	218	227	262	246	180	244	280	1.900
249	220	241	264	294	278	195	269	305	1.850
276	245	265	301	326	310	210	293	330	1.800
304	270	288	339	358	342	225	318	355	1.750
331	295	312	376	390	374	240	342	380	1.700
359	319	335	413	422	406	255	367	405	1.650
386	344	359	450	454	438	270	392	430	1.600
414	369	382	487	486	470	285	416	455	1.550
441	393	406	524	518	502	300	441	480	1.500
469	418	430	562	550	534	315	465	505	1.450
496	443	453	599	582	566	330	490	530	1.400
524	467	477	636	614	598	345	514	555	1.350
551	492	500	673	646	630	360	539	580	1.300
579	517	524	710	678	662	375	563		1.250
606			747	710	694	390	597		1.200
634			784	742		405			1.150
									1.100
									1.050
									1.000
									0.950
									0.900
									0.850
1.100	1.200	1.180	1.100	1.100	1.125	1.130	1.135	1.230	Maximum Coil Bind Height
731	732	724	731	736	733		732	731	Ti. Ret. (Std. Weight)
720	721		720			785	721	720	Ti. Ret. (Light Weight)
741	741	748				703 705			Steel Ret. (Std. Weight)
1731	1732	1732	1732				1732	1731	Steel Ret. (Light Weight)
4785	4781	4772	4776		4774	4711	4778	4785	Seat 0.570 Guide Diameter
	4782	4773	4777		4775		4780	4777	Seat 0.630 Guide Diameter
4700	4700	4700	4702	4702	4702	4702	4700	4700	Spring Cup (O.D. Locator)
4757	4757	4757	4757	4756	4756	4757	4757	4757	Shims



PART #	955	932	996	959	26115	26099	947
# of Springs	Double	Double	Double	Double	Double	Double	Triple
Installed Height	2.000	2.000	2.000	2.000	2.050	2.050	2.050
O.D. of Outer	1.550	1.557	1.625	1.645	1.549	1.625	1.645
I.D. of Outer	1.136	1.143	1.175	1.195	1.125	1.175	1.195
I.D. of Inner	.812	.749	.769	.871	.719	.769	.871/.635
Spring Rate	526	452	637	580	544	563	681
Damper	No	Yes	Yes	No	Yes	Yes	No
SPRING HEIGHT (INCHES)				SPRING LOADS (LBS.)			
2.300							
2.250							
2.200							
2.150							
2.100					201	217	270
2.050	214	174	243	207	225	250	304
2.000	240	196	275	236	255	273	338
1.950	266	219	307	265	283	301	372
1.900	293	242	338	294	310	329	406
1.850	319	264	370	323	337	357	440
1.800	345	287	402	352	364	385	474
1.750	371	309	434	381	391	413	508
1.700	398	332	466	410	418	441	542
1.650	424	355	498	439	446	469	576
1.600	450	377	529	468	473	497	610
1.550	477	400	561	497	500	525	644
1.500	503	422	593	526	527	553	678
1.450	529	445	625	555	554	581	712
1.400	555	468	657	584	582	609	746
1.350	582	490	689	613	609	637	781
1.300	608	513	721	642	633	665	815
1.250		535	752	671	663	672	849
1.200		558	784	700			883
1.150		581	816	729			917
1.100							
1.050							
1.000							
0.950							
0.900							
0.850							
Maximum Coil Bind Height	1.230	1.160	1.100	1.130	1.192	1.184	1.145
Ti. Ret. (Std. Weight)	731	738	733	739	732	733	739 735
Ti. Ret. (Light Weight)	720						722
Steel Ret. (Std. Weight)	749	748			748		
Steel Ret. (Light Weight)	1731				1732		
Seat 0.570 Guide Diameter	4785	4772	4774		4781	4774	
Seat 0.630 Guide Diameter	4777	4773	4775		4782	4775	
Spring Cup (O.D. Locator)	4700	4700	4702	4702	4700	4702	4702
Shims	4757	4757	4756	4756	4757	4757	4756

26956	948	26082	26955	26957	26028	PART #
Double	Triple	Triple	Double	Double	Triple	# of Springs
2.100	2.100	2.100	2.150	2.150	2.200	Installed Height
1.500	1.645	1.680	1.500	1.500	1.686	O.D. of Outer
1.050	1.195	1.195	1.050	1.050	1.195	I.D. of Outer
.719	.871/.635	.871/.635	.719	.719	.872/.634	I.D. of Inner
822	687	761	822	826	712	Spring Rate
No	No	No	No	No	No	Damper
SPRING LOADS (LBS.)						SPRING HEIGHT (INCHES)
						2.300
207			389	357	310	2.250
248			430	399	342	2.200
289	298	344	471	440	382	2.150
330	332	382	512	481	419	2.100
371	366	420	553	523	455	2.050
412	401	458	594	564	492	2.000
453	435	496	635	605	528	1.950
494	469	534	677	647	564	1.900
536	504	572	718	688	601	1.850
577	538	610	759	729	637	1.800
618	572	648	800	770	674	1.750
659	606	686	841	812	710	1.700
700	641	724	882	853	746	1.650
741	675	763	923	894	783	1.600
782	709	801	964	936	819	1.550
823	744	839	1005	977	856	1.500
864	778	877	1046	1018	892	1.450
905	812	915	1088	1060	928	1.400
947	847	953	1129	1101	965	1.350
988	881	991	1170	1142	1001	1.300
1029	915	1029	1211	1183	1038	1.250
1070	950	1067	1293	1225	1054	1.200
		1105				1.150
						1.100
						1.050
						1.000
						0.950
						0.900
						0.850
1.130	1.130	1.130	1.130	1.130	1.161	Maximum Coil Bind Height
718	739 735	739 735	718	718	739 735	Ti. Ret. (Std. Weight)
	722	722			722	Ti. Ret. (Light Weight)
						Steel Ret. (Std. Weight)
1718			1718	1718		Steel Ret. (Light Weight)
						Seat 0.570 Guide Diameter
						Seat 0.630 Guide Diameter
4796, 4784	4702	4708	4796, 4784	4796, 4784	4708	Spring Cup (O.D. Locator)
4755	4756	4756	4755	4755	4756	Shims



#740-16

COMPONENTS VALVE SPRINGS

STEEL RETAINERS

Valve springs with larger diameters require retainers to handle the higher pressures developed by the springs. COMP Cams® steel retainers are precision machined from 4140 chromomoly steel and finished in black oxide. These precision retainers are specifically designed for positive location when combined with COMP Cams® high-quality valve springs. For superior strength and ultimate stability, both 7° and 10° retainers and valve locks are available. Refer to the spring application chart on pages 293-303 for correct retainer part numbers for each COMP Cams® valve spring.

DESCRIPTION	ANGLE	VALVE STEM SIZE	VALVE SPRING DIAMETER	DIA. 1	DIA. 2	DIA. 3	DIA. 4	PART #	TOOL STEEL PART #	TITANIUM PART #
Ford 4.6L W/ 4 Valve Head & #26123 Beehive™	7°	Stock	.943"	.900"	.570"	—	—	799-32	—	798-32
Ford 4.6L W/ 3 Valve Head & #26113/#26125 Beehive™	7°	Stock	.959"	.930"	.630"	—	—	710-24	1723-24	702-24
Ford 4.6L W/ 2 Valve Head & #26113 Beehive™	7°	Stock	.959"	.930"	.630"	—	—	792-16	1723-16	791-16
GM 6.6L Duramax W/ #26113/#26125 Beehive™	7°	Stock	.959"-1.013"	.930"	.630"	—	—	701-32	—	—
Ford 3.8L/4.2L	7°	Stock	Stock	.930"	.640"	—	—	786-12	—	—
Chrysler Hemi 5.7L W/ #26915/#26918 Beehive™	7°	Stock	1.055"	1.000"	.640"	—	—	761-16	—	—
GM Gen III STD "NHRA" Stocker	7°	Stock	1.215"	1.030"	.610"	—	—	783-16	—	—
GM Gen III W/ #26915/#26918 Beehive™	7°	Stock	1.055"	1.030"	.640"	—	—	774-16	1772-16	772-16
#26915/#26918 in Non Gen III Engine	7°	11/32"	1.055"	1.030"	.640"	—	—	787-16	1787-16	788-16
Honda/Acura B18 w/ DOHC	7°	Stock	Stock	1.103"	.868"	.608"	—	778-16	—	760-16
Chevrolet V6 & Small Block, Buick V6	7°	11/32"	1.250"	1.230"	.870"	.650"	—	742-16	—	—
Steel Retainer for 26925 in LS	7°	8mm	1.320"	1.200"	.945"	.675"	—	713-16	1717-16	717-16
Steel Retainer for 26925 in non LS	7°	11/32"	1.320"	1.200"	.945"	.675"	—	714-16	—	—
GM Gen III w/ 1.430"-1.460" O.D. Spring	7°	Stock	1.430"-1.460"	1.300"	1.070"	.690"	—	775-16	—	—
Steel Retainer w/ 1.430"-1.460" O.D. Spring	7°	11/32"	1.437"-1.500"	1.400"	1.030"	.690"	—	768-16	—	—
Chevy, Small Block Ford, Olds, Pontiac	7°	11/32"	1.437"-1.500"	1.400"	1.060"	.690"	—	743-16	—	—
Big Block Chevy, Chrysler, Big Block Ford	7°	3/8"	1.437"-1.500"	1.400"	1.060"	.690"	—	744-16	—	—
7° Version of #741 (11/32")	7°	11/32"	1.500"-1.550"	1.500"	1.115"	.690"	—	782-16	—	—
7° Version of #741 (3/8")	7°	3/8"	1.500"-1.550"	1.500"	1.115"	.690"	—	780-16	—	—
Steel Retainer for #26120 Beehive™	10°	All	1.095"	1.050"	.640"	—	—	795-16	1795-16	794-16
Steel Retainer for #26095 Beehive™	10°	All	1.185"	1.150"	.725"	.466"	—	703-16	—	785-16
Steel Retainer for #26095 Beehive™ +.050" over #703	10°	All	1.185"	1.150"	.725"	.466"	—	705-16	—	785-16
Steel Retainer for #983 Ovate Wire Spring	10°	All	1.250"	1.240"	.820"	.735"	—	751-16	—	—
Super Lock™ Retainer	10°	All	1.250"	1.240"	.870"	.735"	—	750-16	1750-16	728-16
Super Lock™ Retainer	10°	All	1.437"-1.500"	1.400"	1.050"	.690"	—	747-16	—	730-16
Super Lock™ Retainer	10°	All	1.437"-1.500"	1.400"	1.060"	.690"	—	740-16	1730-16	730-16
Super Lock™ Retainer	10°	All	1.500"-1.550"	1.500"	1.095"	.710"	—	748-16	1732-16	732-16
Super Lock™ Retainer	10°	All	1.500"-1.550"	1.500"	1.115"	.690"	—	741-16	1731-16	731-16
Super Lock™ Retainer for Triple Springs	10°	All	1.500"-1.550"	1.500"	1.120"	.830"	.640"	746-16	—	—
Super Lock™ Retainer	10°	All	1.500"-1.550"	1.500"	1.125"	.745"	—	749-16	—	—
Buick 350-455 Steel Retainer	11°	11/32"	1.225"-1.250"	1.200"	.860"	.600"	—	712-16	—	—

Note: Refer to spring application chart for correct retainers for each part number COMP Cams® spring.

Also available in singles (-1) and bulk (-100)

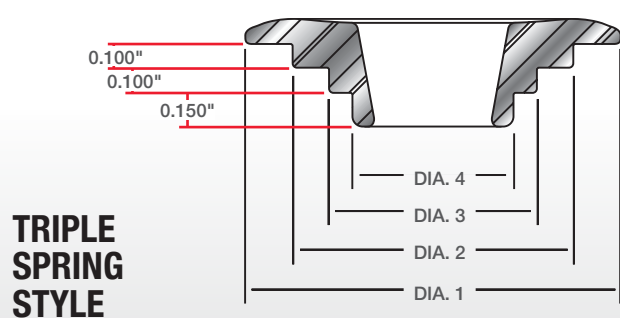
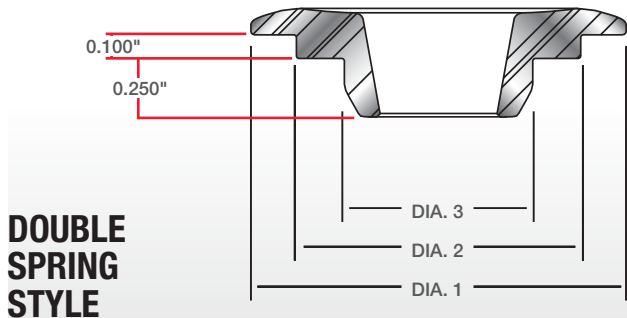



#1732-16

COMPONENTS VALVE SPRINGS

LIGHTWEIGHT TOOL STEEL RETAINERS

COMP Cams® Lightweight Tool Steel Retainers provide the best of all valve train benefits: light weight, along with exceptional strength and wear characteristics. Approximately 33% lighter than conventional chromemoly steel retainers and only 2-4 grams heavier than titanium (depending upon application), they are made from high-grade tool steel, making them able to withstand even the most demanding race applications.

- CNC-machined for consistent quality
- Developed using latest FEA and CAD software
- Spintron®-tested to extreme RPM to prove strength is equivalent to titanium and stronger than chromemoly steel
- Designed for both 7° and 10° angles

DESCRIPTION	ANGLE	VALVE STEM SIZE	VALVE SPRING DIAMETER	DIA. 1	DIA. 2	DIA. 3	DIA. 4	PART #	STEEL PART #	TITANIUM PART #
Tool Steel Retainer	7°	11/32"	1.055"	1.030"	.640"	—	—	1787-16	787-16	788-16
Tool Steel Retainer for #26056 Spring	7°	7mm	1.185"	1.050"	.725"	.340"	—	1757-16	705-16	—
Tool Steel Version of #754 Retainer	7°	8mm	1.250"	1.235"	.860"	.610"	—	1754-16	—	754-16
Tool Steel Version of #772 Retainer	7°	8mm	1.290"	.948"	.640"	—	—	1772-16	774-16	772-16
Tool Steel Retainer for #26926 Springs	7°	Stock	1.290"	1.172"	.910"	.646"	—	1779-16	—	779-16
Tool Steel Retainer for #26926 in non LS Applications	7°	11/32"	1.290"	1.172"	.910"	.646"	—	1777-16	—	—
Tool Steel Retainer for #26926 in Dodge V10	7°	8mm	1.290"	1.190"	.910"	.646"	—	1737-16	—	—
Tool Steel Retainer for #26925 Springs	7°	8mm	1.320"	1.200"	.945"	.675"	—	1717-16	713-16	717-16
Tool Steel Retainer	10°	All	1.095"	.900"	.640"	—	—	1795-16	795-16	794-16
Tool Steel Retainer for #26056 Spring	10°	All	1.185"	1.050"	.725"	.466"	—	1756-16	705-16	—
Tool Steel Retainer	10°	All	1.250"	1.240"	.870"	.735"	—	1750-16	750-16	728-16
Tool Steel Retainer for #26955, #26956, #26957 Springs	10°	All	1.437"-1.500"	1.375"	1.035"	.710"	—	1718-16	—	718-16
Tool Steel Retainer	10°	All	1.437"-1.500"	1.375"	1.065"	.700"	—	1730-16	740-16	730-16
Tool Steel Retainer	10°	All	1.500"-1.550"	1.387"	1.100"	.800"	—	1731-16	741-16	731-16
Tool Steel Retainer	10°	All	1.500"-1.550"	1.450"	1.100"	.710"	—	1732-16	748-16	732-16

Note: Refer to spring application chart for correct retainers for each part number COMP Cams® spring.

Also available in singles (-1)

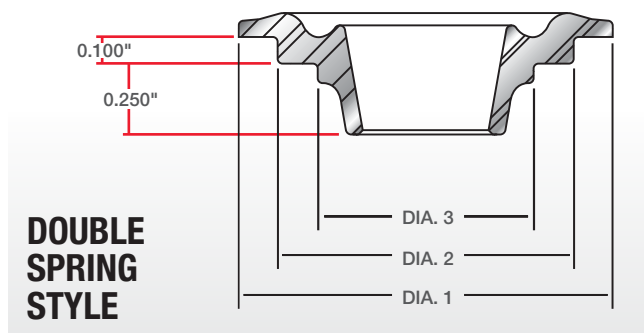

HAVE QUESTIONS?
WE CAN HELP YOU

Just Call Our
Toll Free Tech Line

CAMHELP®
800.999.0853

TITANIUM RETAINERS

Upgrading to COMP Cams® titanium valve spring retainers will often allow you to gain speed and power because titanium retainers are lighter and as strong as than most steel ones. Additionally, our Super Lock™ titanium design gives you confidence; no longer will you be preoccupied with splitting a retainer and tearing up an engine when turning 10,000 RPM.

COMP Cams® titanium retainers are made from the finest 6AL4V alloy for maximum stiffness and minimal warpage. The 6AL4V alloy is heat-treated and processed to a stringent tolerance that makes it extremely strong. Other manufacturers purchase titanium from metal brokers and produce “cheap” retainers, but COMP Cams® titanium retainers will not deform. From a standing idle to the most extreme RPM, our titanium retainers perform flawlessly and without compromise.



- Better material consistency
- Superior grain structure
- Bullet proof durability
- Designed for both 7° & 10° lock angles

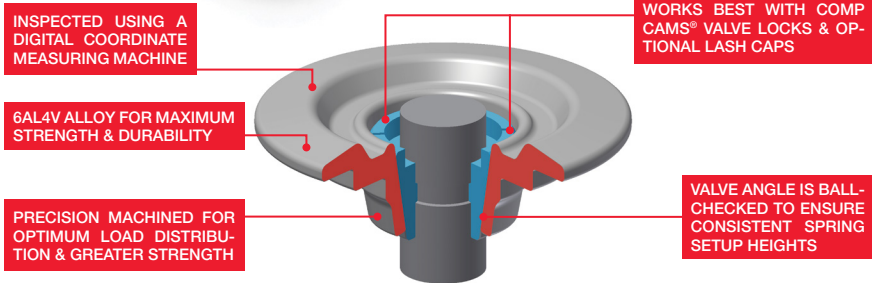

DESCRIPTION	ANGLE	VALVE STEM SIZE	VALVE SPRING DIAMETER	DIA. 1	DIA. 2	DIA. 3	DIA. 4	PART #	STEEL PART #	TOOL STEEL PART #
Honda D16Z6 (VTEC) w/ SOHC	Stock	Stock	.825"	.825"	.590"	—	—	753-16	—	—
Ford 4.6L w/ 4 Valve Head & #26123 Beehive™	7°	Stock	.943"	.900"	.570"	—	—	798-32	799-32	—
Ford 4.6L w/ 3 Valve Head & #26113 Beehive™	7°	Stock	.959"	.930"	.630"	—	—	702-24	710-24	1723-24
Ford 4.6L w/ 2 Valve Head & #26113 Beehive™	7°	Stock	.959"	.930"	.630"	—	—	791-16	792-16	1723-16
Chrysler Hemi 5.7L w/ #26915/#26918	7°	Stock	1.055"	1.000"	.640"	—	—	762-16	761-16	—
GM Gen III W/ #26915 or #26918	7°	8 mm	1.055"	1.030"	.640"	—	—	772-16	774-16	1772-16
#26915/#26918 in Non Gen III Engine	7°	11/32"	1.055"	1.030"	.640"	—	—	788-16	787-16	1787-16
Acura B18C (VTEC) W/ DOHC	Stock	Stock	1.103"	1.103"	.868"	.608"	—	760-16	778-16	—
Titanium Retainer for #26921 Spring	7°	8 mm	1.250"	1.235"	.860"	.610"	—	754-16	—	1754-16
Titanium Retainer for #26925	7°	8 mm	1.320"	1.270"	.945"	.675"	—	717-16	713-16	1717-16
Titanium Retainer for #26926	7°	8 mm	1.320"	1.265"	.910"	.646"	—	779-16	—	1779-16
GM Gen III w/ 1.430"-1.460" O.D. Spring	7°	8 mm	1.430"-1.460"	1.300"	1.070"	.690"	—	776-16	—	—
Titanium Retainer for #26120 Beehive™	10°	All	1.300"	1.050"	.640"	—	—	794-16	795-16	1795-16
Titanium Retainer for #26095 Beehive™	10°	All	1.185"	1.150"	.725"	—	—	785-16	703-16	—
Titanium Retainer for Single Spring	10°	All	1.250"	1.240"	.870"	.735"	—	728-16	750-16	1750-16
Titanium Retainer for #26955, #26956, #26957 Springs	10°	All	1.437"-1.500"	1.375"	1.035"	.710"	—	718-16	—	1718-16
Titanium Retainer for Double Spring	10°	All	1.437"-1.500"	1.437"	1.065"	.700"	—	730-16	740-16	1730-16
Titanium Retainer for Double Spring	10°	All	1.500"-1.550"	1.437"	1.100"	.800"	—	731-16	741-16	1731-16
Titanium Retainer for Double Lightweight	10°	All	1.500"-1.550"	1.437"	1.108"	.708"	—	721-16	—	1732-16
Titanium Retainer for Triple Lightweight	10°	All	1.625"	1.437"	1.178"	.868"	.637"	722-16	—	—
Titanium Retainer for Double Lightweight	10°	All	1.500"-1.550"	1.437"	1.098"	.798"	—	720-16	—	1731-16
Titanium Retainer for #26091 Spring	10°	All	1.625"	1.450"	1.170"	.840"	—	784-16	—	—
Titanium Retainer for Double Spring	10°	All	1.500"-1.550"	1.500"	1.110"	.710"	—	732-16	748-16	1732-16
Titanium Retainer for Double Spring	10°	All	1.500"-1.550"	1.500"	1.120"	.730"	—	738-16	—	1732-16
Titanium Retainer for Double Spring	10°	All	1.500"-1.550"	1.500"	1.120"	.745"	—	727-16	749-16	—
Titanium Retainer for Double Spring	10°	All	1.500"-1.550"	1.500"	1.135"	.730"	—	729-16	—	—
Titanium Retainer for Triple Spring	10°	All	1.500"-1.550"	1.500"	1.135"	.835"	.635"	736-16	—	—
Titanium Retainer for Double Spring	10°	All	1.625"	1.500"	1.180"	.765"	—	733-16	—	—
Titanium Retainer for Triple Spring	10°	All	1.625"	1.500"	1.180"	.870"	.635"	739-16	—	—
Triple + .050" over #739	10°	All	1.625"	1.500"	1.180"	.870"	.635"	735-16	—	—
Buick 350-455 Steel Retainer	11°	11/32"	1.225"-1.250"	1.200"	.860"	.600"	—	712-16	—	—

Note: Refer to spring application chart for correct retainers for each part number COMP Cams® spring.

Also available in singles (-1)



VALVE LASH CAPS

Because today's racing engines run at higher RPM levels with harsh cam profiles, the tip of the valve stem must withstand a tremendous amount of pounding. These engines always run just on the brink of one of the most severe conditions that exists – valve float. The best solution to this problem is the COMP Cams® Valve Lash Caps. These lash caps are precision machined and ground perfectly flat to maintain accuracy of valve train adjustment.

- Ultimate in strength and reliability
- Fit valve stems well and are easily removed
- Special version for short tipped Chrysler Hemi valves
- Necessary for titanium valves

DESCRIPTION	VALVE STEM DIAMETER	OVERALL HEAD HEIGHT	THICKNESS	PART #
426 Hemi (Short Cap) Hardened Lash Cap	5/16"	.190"	.080"	619-16
Hardened Lash Cap	5/16"	.230"	.080"	620-16
Hardened Lash Cap	11/32"	.210"	.080"	621-16
Hardened Lash Cap	3/8"	.190"	.080"	622-16

Note: Dash -1 indicates one piece, dash -8 indicates a set of eight, dash -16 indicates a set of sixteen.



VALVE LOCKS – 7°

Most people believe that the tang inside a valve lock holds the retainer and valve spring in place while the engine is running, but this isn't the case. The cross-section of material in the tang is not strong enough to withstand open spring loads of 1000 lbs. or more. The sole purpose of the tang is to temporarily locate the lock, retainer and spring relative to the valve until the taper of the retainer can nest around the outside surface of the lock. This creates a "collet" effect that binds the two together. The more spring force exerted on the retainer (as the valve opens), the more force applied by the "collet" effect to keep the retainer and lock in place.

With the emergence of valve sizes other than the standard 5/16", 11/32" and 3/8", it is important to make sure the valve locks match the valve size. There should always be a small gap between the two halves of the lock when they are properly positioned on the valve stem. If the two halves fit together without a gap, they are too large. If the locks fit tight to the stem and leave a gap between the middle of the lock and the O.D. of the stem, the locks are too small.

Our line of stock replacement 7° valve locks for stock engine rebuilds are recommended only for street applications with lighter valve spring loads and are stamped and hardened for superior wear resistance. Also available are machined 7° locks and titanium Super 7° Locks for some applications. They offer the same valve spring location accuracy as our Super Locks™ without the need to change to 10° retainers.

DESCRIPTION	LOCK ANGLE	VALVE STEM SIZE	PART #
STEEL STREET LOCKS – 7°			
Hardened Steel, Single Groove	7°	5/16"	600-16
Hardened Steel, Single Groove	7°	11/32"	601-16
Hardened Steel, Single Groove	7°	3/8"	603-16
Hardened Steel, Chrysler, 2 Groove	7°	3/8"	602-16
Hardened Steel, Chrysler, 4 Groove	7°	3/8"	604-16
Hardened Steel, Chrysler, 2 & 4 Groove	7°	3/8"	606-16
Hardened Steel, Ford 351C, 4 Groove	7°	11/32"	605-16

Note: For 4 cylinder use -8 suffix, for 6 cylinder use -12 suffix

DESCRIPTION	LOCK ANGLE	VALVE STEM SIZE	PART #
MACHINED STEEL RACE LOCKS – 7°			
Machined Steel, Single Groove	7°	5/16"	628-16
Machined Steel, Single Groove	7°	11/32"	648-16
Machined Steel, Single Groove	7°	3/8"	641-16
Machined Steel, Single Groove GM Gen III/LS1/LS2/LS6	7°	8mm	623-16
Machined Steel, Single Groove Honda B & D Series	7°	5.5mm	629-16

Also available in singles (-1) and bulk (-100)

Note: For 6 cylinder use -12 suffix

DESCRIPTION	LOCK ANGLE	VALVE STEM SIZE	PART #
TITANIUM VALVE – SUPER 7 (8°)			
Titanium Super 7 ¹	8°	11/32"	636-16

¹ These locks require specific retainers and do not work with standard 7° or 10° retainers



SUPER LOCKS™ – 10°

- Wider angle (10°) locks better distribute increasing valve spring loads over the retainer than typical 7° locks (see diagram below) reducing the chance of “pull-through” failure
- Precision-machined rather than stamped for accuracy
- Super-tough, fatigue resistant alloy material
- Inside tang-to-taper relationship held tightly for repeatable valve spring installed heights
- Available in ± .050" installed height versions
- Any Super Lock™ fits any COMP Cams® 10° retainer, just choose the correct lock for your valve size and application
- Super Locks™ are recommended in all race applications

DESCRIPTION	LOCK ANGLE	VALVE STEM SIZE	PART #
w/ Lash Cap Recess	10°	.308"/5/16"	610-16
w/ Lash Cap Recess	10°	.310"	618-16
w/ Lash Cap Recess	10°	11/32"	611-16
w/ Lash Cap Recess	10°	3/8"	612-16
-.050 Inst. Ht. w/ Lash Cap Recess	10°	11/32"	630-16
-.050 Inst. Ht. w/ Lash Cap Recess	10°	3/8"	609-16
w/o Lash Cap Recess	10°	.310"	617-16
w/o Lash Cap Recess	10°	11/32"	613-16
+.050" Inst. Ht. W/O Lash Cap Recess	10°	11/32"	614-16
+.050" Inst. Ht. W/O Lash Cap Recess	10°	3/8"	616-16
Chrysler 2 Groove	10°	3/8"	625-16
Chrysler 4 Groove	10°	3/8"	626-16
Chrysler 2 & 4 Groove	10°	3/8"	627-16'
LS1/LS6 Bead Lock	10°	8mm	632-16
Ford 4 Groove	10°	11/32"	624-16

Also available in singles (-1) and bulk (-100)

Note: For 4 cylinder use -8 suffix, for 6 cylinder use -12 suffix.

1 8 pair #625 2 groove and 8 pair #626 4 groove

TITANIUM SUPER LOCKS™ – 10°



DESCRIPTION	LOCK ANGLE	VALVE STEM SIZE	PART #
W/ Lash Cap Recess	10°	5/16"	637-16
W/ Lash Cap Recess	10°	11/32"	638-16

Note: For 4 cylinder use -8 suffix, for 6 cylinder use -12 suffix.

INSPECTED USING A DIGITAL COORDINATE MEASURING MACHINE

MADE OF RIGIDLY INSPECTED FATIGUE PROOF ALLOY STEEL

LASH CAP GROOVE AVAILABLE

PRECISION MACHINED USING TIGHT TOLERANCES

LARGER CONTACT AREA VS. 7° LOCKS RESULTS IN OPTIMUM LOAD DISTRIBUTION AND GREATER STRENGTH

ABSOLUTE STEP LOCATION PROVIDES CONSISTENT INSTALLED SPRING HEIGHT

PERFECT FIT TO ALL STEM SIZES

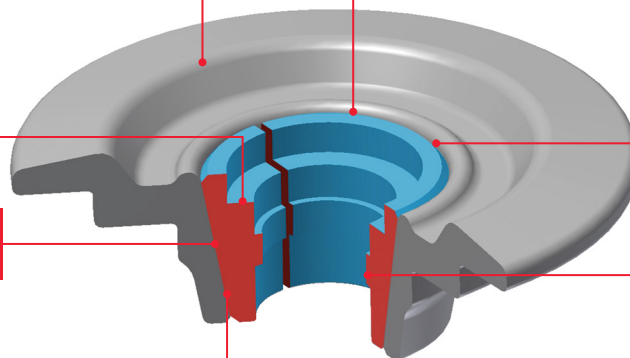



VALVE SPRING LOCATORS

The older style standard shims will not hold up to the extreme spring pressures and high RPM found in racing engines being built today. COMP Cams® offers a simple but effective solution to this problem – a thin, hardened steel alloy seat which will not only protect the head and shim but also locate and hold the spring in place. Previously, this part has been available only in a cup form with the retaining portion being on the outside of the part. This required that the head be machined a great deal to accept this cup so COMP® now offers an I.D. locator with the locating shoulder on the inside, as well as the spring cup. Many sizes are available to locate from the inside or outside diameter.

¹ Designed for #26981 Beehive™ Springs

² Designed for #26915 & #26918 Beehive™ Springs

³ Designed for #26986 & #26995 Beehive™ Springs

⁴ Designed for #26120 Beehive™ Springs

⁵ Designed for #26055 Beehive™ Springs

STAY CONNECTED

Take your pick of our social media platforms to keep up with information on new products, specials and free giveaways, as well as have access to our highly trained technical staff and our ever expanding library of how-to videos.

 [facebook.com/COMPWins](https://www.facebook.com/COMPWins)

 twitter.com/COMPCams

 [CPGNationTV.com](https://www.youtube.com/CPGNationTV.com)

 [CPGNation.com](https://www.CPGNation.com)

DESCRIPTION	LOCATOR		SPRING		LOCATOR THICKNESS	PART #
	O.D.	I.D.	O.D.	I.D.		
SPRING O.D. LOCATOR CUPS						
Spring Cup	1.455"	.570"	1.335"	N/A	.060"	4709-16
Spring Cup	1.570"	.640"	1.475"	N/A	.060"	4704-16
Spring Cup	1.635"	.640"	1.515"	N/A	.060"	4769-16
Spring Cup	1.670"	.640"	1.565"	N/A	.060"	4700-16
Spring Cup	1.730"	.640"	1.650"	N/A	.060"	4702-16
Spring Cup	1.780"	.640"	1.690"	N/A	.060"	4708-16
Spring Cup	1.830"	.640"	1.740"	N/A	.060"	4706-16
SPRING I.D. LOCATORS						
Spring I.D. Locator	1.100"	.470"	N/A	.720"	.060"	4688-16
Spring I.D. Locator	1.270"	.520"	N/A	.650"	.060"	4862-16
Spring I.D. Locator	1.285"	.810"	N/A	.875"	.040"	4679-16
Spring I.D. Locator	1.285"	.810"	N/A	.875"	.135"	4678-16
Spring I.D. Locator	1.300"	.510"	N/A	.875"	.060"	4861-16
Spring I.D. Locator	1.300"	.520"	N/A	.640"	.060"	4695-16
Spring I.D. Locator	1.300"	.520"	N/A	.670"	.060"	4873-16
Spring I.D. Locator	1.300"	.520"	N/A	.875"	.060"	4872-16
Spring I.D. Locator	1.300"	.570"	N/A	.650"	.060"	4682-16
Spring I.D. Locator	1.300"	.570"	N/A	.800"	.060"	4693-16¹
Spring I.D. Locator	1.300"	.570"	N/A	.840"	.060"	4863-16
Spring I.D. Locator	1.300"	.570"	N/A	.875"	.060"	4705-16²
Spring I.D. Locator	1.300"	.810"	N/A	.875"	.205"	4683-16
Spring I.D. Locator	1.340"	.570"	N/A	.650"	.100"	4731-16
Spring I.D. Locator	1.350"	.515"	N/A	.875"	.050"	4868-16
Spring I.D. Locator	1.350"	.515"	N/A	.875"	.150"	4869-16
Spring I.D. Locator	1.400"	.520"	N/A	.690"	.060"	4712-16
Spring I.D. Locator	1.450"	.570"	N/A	1.000"	.060"	4694-16³
Spring I.D. Locator	1.500"	.570"	N/A	.735"	.060"	4784-16
Spring I.D. Locator	1.500"	.585"	N/A	.690"	.060"	4770-16
Spring I.D. Locator	1.510"	.570"	N/A	.970"	.060"	4696-16⁴
Spring I.D. Locator	1.510"	.630"	N/A	.970"	.060"	4697-16⁴
Spring I.D. Locator	1.540"	.640"	N/A	.690"	.060"	4783-16
Spring I.D. Locator	1.540"	.640"	N/A	.715"	.060"	4782-16
Spring I.D. Locator	1.540"	.640"	N/A	.730"	.060"	4780-16
Spring I.D. Locator	1.540"	.640"	N/A	.750"	.060"	4773-16
Spring I.D. Locator	1.540"	.640"	N/A	.765"	.060"	4775-16
Spring I.D. Locator	1.540"	.640"	N/A	.790"	.060"	4777-16
Spring I.D. Locator	1.550"	.570"	N/A	.810"	.040"	4759-16
Spring I.D. Locator	1.550"	.570"	N/A	.690"	.060"	4771-16
Spring I.D. Locator	1.550"	.570"	N/A	.715"	.060"	4781-16
Spring I.D. Locator	1.550"	.570"	N/A	.730"	.060"	4778-16
Spring I.D. Locator	1.550"	.570"	N/A	.750"	.060"	4772-16
Spring I.D. Locator	1.550"	.570"	N/A	.750"	.060"	4691-16
Spring I.D. Locator	1.550"	.570"	N/A	.790"	.060"	4776-16
Spring I.D. Locator	1.550"	.570"	N/A	.810"	.060"	4785-16
Spring I.D. Locator	1.565"	.535"	N/A	1.125"	.100"	4713-16
Spring I.D. Locator	1.590"	.570"	N/A	1.130"	.060"	4711-16
Spring I.D. Locator	1.600"	.570"	N/A	.840"	.060"	4714-16
Spring I.D. Locator	1.600"	.570"	N/A	1.097"	.060"	4640-16⁵
Spring I.D. Locator	1.625"	.570"	N/A	.765"	.060"	4774-16
Spring I.D. Locator	1.635"	.570"	N/A	.870"	.060"	4786-16
Spring I.D. Locator	1.655"	.570"	N/A	.630"	.060"	4860-16
Spring I.D. Locator	1.253"	.780"	N/A	.875"	.120"	4690-16

Also available in singles (-1) and bulk (-100)



VALVE SPRING SHIMS AND KITS

- Equalize installed height of valve spring
- Engineered from the highest quality shim stock
- Heat-treated to withstand radical camshaft lobes
- Available in three different thicknesses to help achieve proper valve spring height
- Shim kits contain (16) pieces of each thickness listed

O.D.	I.D.	THICKNESS	PART #
1.250"	.814"	.015"	4736-16
1.250"	.814"	.030"	4742-16
1.250"	.814"	.060"	4748-16
1.437"	.645"	.015"	4737-16
1.437"	.645"	.030"	4743-16
1.437"	.645"	.060"	4749-16
1.480"	.765"	.015"	4738-16
1.480"	.765"	.030"	4744-16
1.480"	.765"	.060"	4750-16
1.500"	.645"	.015"	4739-16
1.500"	.645"	.030"	4745-16
1.500"	.645"	.060"	4751-16
1.640"	.635"	.015"	4740-16
1.640"	.635"	.030"	4746-16
1.640"	.650"	.060"	4752-16
SHIM KITS			
1.250"	.814"	.015", .030", .060"	4753
1.437"	.645"	.015", .030", .060"	4754
1.480"	.765"	.015", .030", .060"	4755
1.500"	.645"	.015", .030", .060"	4757
1.640"	.635"- .650"	.015", .030", .060"	4756

Also available in singles (-1) and bulk (-100)

BIG BLOCK CHEVROLET SEAT SPACERS

Late model Big Block Chevrolet engines are originally equipped with exhaust valve rotators. Until now, the only way to make up for the rotator was to stack .300" of shims under the spring. This was not only sloppy, but they also didn't fit well. These seat spacers offered by COMP Cams® will locate the spring with an outside step so the spring cannot "walk" around on the head.



#4779-8

DESCRIPTION	O.D.	SPRING O.D.	SPRING I.D.	THICKNESS	PART #
Chevrolet Big Block Exhaust Rotator Eliminator	1.732"	1.568"	0.623"	.300"	4779-8
Chevrolet Big Block Exhaust Rotator Eliminator for #26120 Beehive™	1.732"	1.468"	0.630"	.300"	4698-8

Individual shims available in singles (-1) and bulk (-100)

VALVE SPRING ACCESSORIES



VALVE TRAIN ASSEMBLY SPRAY

See page 235 for details



VALVE SPRING HEIGHT MICROMETERS

See page 336 for details



VALVE SPRING COMPRESSORS

See page 334 for details

SPRING SEAT AND GUIDE CUTTERS/ARBORS

These tools from COMP Cams® will allow machining of the cylinder head to the proper size for your spring. Each cutter requires the use of an arbor/pilot, which is available in three different sizes. These arbors/pilots will also work with the valve guide cutters used for shortening the guide for a high lift cam or installing a COMP Cams® PTFE seal for oil control.

- Seat cutters available in many sizes from 1.320"-1.810" O.D.
- Valve guide cutters available to cut guide to .446", .494", .500", .530" or .625"
- Arbors/pilots available for 5/16", 11/32" and 3/8" diameters

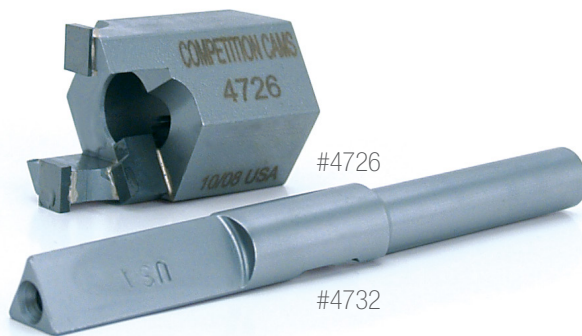

DESCRIPTION	CUTS GUIDE	PART #
SPRING SEAT CUTTERS		
1.320" Spring Seat Cutter, To Install Larger Springs & Hardened Spring Seat on GM Vortec Head	.630"	4716
1.350" Spring Seat Cutter, To Install Single Springs On GM Vortec Head W/O Hardened Spring Seat	.775"	4721
1.440" Spring Seat Cutter	.560"	4733
1.440" Spring Seat Cutter	.630"	4718
1.550" Spring Seat Cutter	.630"	4719
1.580" Spring Seat Cutter	.560"	4735
1.580" Spring Cup Cutter	.630"	4720
1.680" Spring Seat Cutter	.560"	4741
1.680" Spring Cup Cutter	.630"	4722
1.740" Spring Cup Cutter	.630"	4724
1.810" Spring Cup Cutter, Use W/ #26028 and #26030 Race Springs	.630"	4723
VALVE GUIDE CUTTERS		
Valve Guide Cutter	.425"	4703
Valve Guide Cutter	.446"	4727
Valve Guide Cutter	.494"	4725
Valve Guide Cutter	.500"	4715
Valve Guide Cutter	.530"	4726
Valve Guide Cutter	.625"	4728
Stud Boss Cutter	N/A	4729
ARBOR/PILOTS		
5/16" Arbor/Pilot for Seat & Guide Cutters	N/A	4730
11/32" Arbor/Pilot for Seat & Guide Cutters	N/A	4732
3/8" Arbor/Pilot for Seat & Guide Cutters	N/A	4734

VALVE STEM OIL SEALS

COMP Cams® offers a complete line of valve stem oil seals, from the stock GM o-ring to the positive-stop PTFE seal. These seals are a must to keep unwanted oil from entering the combustion chamber through the clearance in the valve guides. The o-ring seals use the standard retainer and oil splash shield. The umbrella seal is normally used when a larger-than-stock diameter spring is used, and in the case of a double spring, the positive-stop PTFE seal is used. Smaller diameter Viton seals are also available for triple spring applications. Both the o-ring and the umbrella seals require no machining, but when using the PTFE seal it is necessary to disassemble the heads and machine the top of the guide with a special cutter, which can also be found on this page.



DESCRIPTION	VALVE SIZE	GUIDE SIZE	VALVE SIZE	PART #
O-Ring	11/32"	Stock	.400"	501-16
Umbrella	11/32"	Stock	.750"	502-16
Umbrella	3/8"	Stock	.900"	504-16
Positive Stop PTFE	5/16"	.500"	.600"	513-16
Positive Stop PTFE	5/16"	.530"	.626"	500-16
Positive Stop PTFE	11/32"	.500"	.600"	510-16
Positive Stop PTFE	11/32"	.530"	.630"	503-16
Positive Stop PTFE	3/8"	.500"	.600"	512-16
Positive Stop PTFE	3/8"	.530"	.626"	505-16
Steel Jacketed Viton Seal for LS1, #26921-KIT	8mm	.500"	.600"	511-16
Metal Body Viton Seal	5/16"	.530"	.675"	516-16
Metal Body Viton Seal	11/32"	.530"	.675"	529-16
Metal Body Viton Seal	3/8"	.500"	.621"	514-16
Metal Body Viton Seal	3/8"	.530"	.675"	515-16
Black Viton Valve Seal (Small O.D. for Triple Spring)	5/16"	.425"	.566"	530-16
Black Viton Seal For Use with Triple Spring	5/16"	.446"	.585"	507-16
Black Viton Valve Seal (Small O.D. for Triple Spring)	11/32"	.494"	.610"	506-16
Metal Body Viton Seal For Use with Triple Spring	5/16"	.500"	.500"	519-16
Metal Body Viton Seal For Use with Triple Spring	5/16"	.530"	.530"	520-16
Metal Body Viton Seal For Use with Triple Spring	11/32"	.500"	.546"	517-16
Metal Body Viton Seal For Use with Triple Spring	11/32"	.530"	.575"	518-16
Metal Body Viton Seal For Use with Triple Spring	3/8"	.500"	.500"	521-16
Metal Body Viton Seal For Use with Triple Spring	3/8"	.530"	.530"	522-16

Note: For 4 cylinder use - 8 suffix, for 6 cylinder use -12 suffix.

SPORTSMAN VALVES

COMP Cams® Sportsman Valves are available in a variety of materials, diameters and stem lengths for street and competition engines. The stainless steel valves are made from 21-4N forged steel alloy with 50 HRC minimum hard tips (eliminating lash caps); these valves deliver tremendous performance and durability. The hard chrome-plated 11/32" stems utilize proprietary oil retention surfacing. For extremely high revving LS applications, COMP® engineers developed titanium valves. Weighing 35% less than stainless steel, titanium valves are a must for race applications where valve float is not an option. For high temperature and high boost applications, valves constructed from Inconel superalloy are also available.



DESCRIPTION	INTAKE/ EXHAUST	HEAD DIAMETER	OVERALL LENGTH	LOCK GROOVE	STEM SIZE	MATERIAL	PART #
Chevrolet 265-400	Intake	1.940"	4.911"	Single	11/32"	Stainless Steel	6006-8
Chevrolet 265-400	Intake	1.940"	5.011"	Single	11/32"	Stainless Steel	6014-8
Chevrolet 265-400	Intake	2.020"	4.911"	Single	11/32"	Stainless Steel	6004-8
Chevrolet 265-400	Intake	2.020"	5.011"	Single	11/32"	Stainless Steel	6001-8
Chevrolet 265-400	Intake	2.020"	5.111"	Single	11/32"	Stainless Steel	6009-8
Chevrolet 265-400	Intake	2.055"	5.011"	Single	11/32"	Stainless Steel	6018-8
Chevrolet 265-400	Intake	2.080"	4.911"	Single	11/32"	Stainless Steel	6013-8
Chevrolet 265-400	Intake	2.080"	5.011"	Single	11/32"	Stainless Steel	6003-8
Chevrolet 265-400	Intake	2.080"	5.111"	Single	11/32"	Stainless Steel	6007-8
Chevrolet 265-400	Exhaust	1.500"	4.911"	Single	11/32"	Stainless Steel	6016-8
Chevrolet 265-400	Exhaust	1.600"	4.911"	Single	11/32"	Stainless Steel	6011-8
Chevrolet 265-400	Exhaust	1.600"	5.011"	Single	11/32"	Stainless Steel	6002-8
Chevrolet 265-400	Exhaust	1.600"	5.111"	Single	11/32"	Stainless Steel	6012-8
Chevrolet 396-454	Intake	2.250"	5.468"	Single	See Note Below*	Stainless Steel	6022-8
Chevrolet 396-454	Intake	2.300"	5.468"	Single	See Note Below*	Stainless Steel	6021-8
Chevrolet 396-454	Exhaust	1.880"	5.454"	Single	See Note Below*	Stainless Steel	6023-8
GM Gen III LS1/LS2/LS6	Intake	2.020"	4.900"	Single	8mm	Stainless Steel	6039-8
GM Gen III LS1/LS2/LS6	Intake	2.040"	5.450"	Single	8mm	Stainless Steel	6052-8
GM Gen III LS1/LS2/LS6	Intake	2.055"	4.900"	Single	8mm	Stainless Steel	6046-8
GM Gen III LS1/LS2/LS6	Intake	2.080"	4.900"	Single	8mm	Stainless Steel	6047-8
GM Gen III LS1/LS2/LS6	Intake	2.080"	5.450"	Single	8mm	Stainless Steel	6051-8
GM Gen III LS1/LS2/LS6	Exhaust	1.570"	4.930"	Single	8mm	Stainless Steel	6048-8
GM Gen III LS1/LS2/LS6	Exhaust	1.570"	5.450"	Single	8mm	Stainless Steel	6054-8
GM Gen III LS1/LS2/LS6	Exhaust	1.600"	4.930"	Single	8mm	Stainless Steel	6049-8
GM Gen III LS1/LS2/LS6	Exhaust	1.600"	5.450"	Single	8mm	Stainless Steel	6053-8
GM Gen IV LS7	Intake	2.200"	5.550"	Bead Lock	8mm	Stainless Steel	6062-8
GM Gen IV LS7	Intake	2.200"	5.565"	Bead Lock	8mm	Titanium	6064-8
GM Gen IV LS7	Intake	2.250"	5.695"	Bead Lock	5/16"	Titanium	6068-8
GM Gen IV LS7	Exhaust	1.615"	5.685"	Bead Lock	8mm	Titanium	6069-8
GM Gen IV LS7	Exhaust	1.615"	5.590"	Bead Lock	8mm	Stainless Steel	6063-8
GM Gen IV LS7	Exhaust	1.615"	5.590"	Bead Lock	8mm	Inconel	6067-8
GM Gen IV LS7	Exhaust	1.615"	5.595"	Bead Lock	8mm	Titanium	6066-8

* Big Block Chevrolet factory valve stem size is 3/8", however all COMP Cams® Big Block Chevy valves listed feature 11/32" valve stem diameter for increased flow and less weight

TIMING TECH

Advancing or retarding a camshaft moves the engine's torque band around the RPM scale by moving the valve events further ahead or behind the movement of the piston. Typically, a racer will experiment with advancing or retarding a cam from "straight up" to determine what works best for his or her engine. COMP Cams® camshafts are ground to provide maximum performance and are designed to be installed to the specifications listed on the cam spec card that ships with each camshaft we sell.

HOW IS IT MEASURED?

A cam with a 107° intake lobe centerline will actually be centered at 103° ATDC when installed 4° advanced.

Most COMP® camshafts have a certain amount of advance ground in. "Ground-in advance" can also be found by subtracting the intake lobe centerline from the lobe separation.

WHAT DOES IT DO?

Advance improves low-end power and response. Retard allows more time for cylinder filling, therefore creating more power at high RPM. For a general summary of the effects of camshaft timing, refer to the following tables:

ADVANCE

- Earlier Intake Closing Creates More Cylinder Pressure At Lower RPM
- Earlier Exhaust Opening Creates Less Pumping Losses
- Builds More Low-End Torque & Throttle Response
- Decreases Piston-To-Intake-Valve Clearance
- Increases Piston-To-Exhaust-Valve Clearance

RETARD

- Later Intake Closing Delays Maximum Cylinder Pressure
- Later Exhaust Opening Allows For Longer Power Stroke
- Builds More High-End Power
- Increases Piston-To-Intake-Valve Clearance
- Decreases Piston-To-Exhaust-Valve Clearance

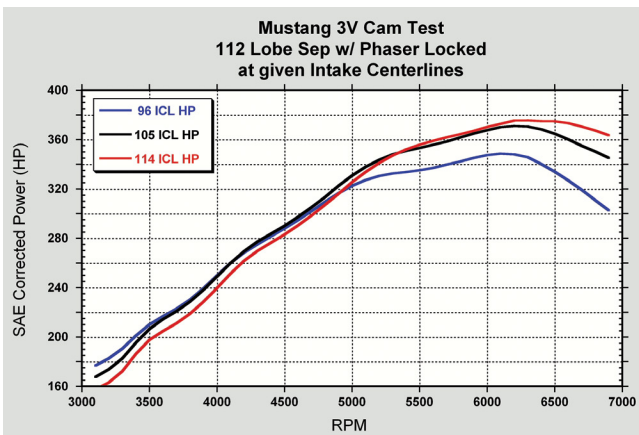

This chart shows the results of a dyno test performed on a 4.6L 3 Valve Ford engine. The cam set tested featured a 112° lobe separation. The test illustrates how changing the intake centerlines affects horsepower at different RPM ranges.

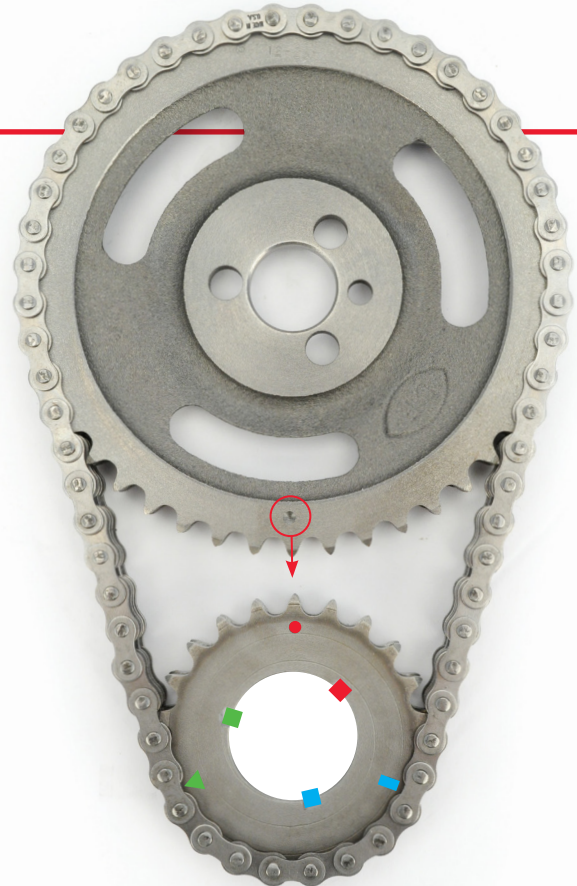

To install your camshaft "straight up," make sure to align the dot on the cam gear directly above the dot on the crank gear. At this position your camshaft's intake centerline should be the same as the lobe separation. If you want to advance your camshaft 4° you would align the dot on the camshaft gear directly above the triangle on the crank gear. The crankshaft would also need to be moved to the keyway to the right of the triangle. At this position your intake centerline should be 4° less than the lobe separation of your camshaft. To retard the cam, you would use the same process but align the cam dot to the square rather than the triangle. This will make your intake centerline 4° more than the lobe separation.

Many COMP Cams® camshafts have a certain amount of advance already ground into them – check your spec card to verify. If the cam already has advance you should install it with the dots on the cam and crank gear together, or "dot-to-dot."

TECH TIP

Always remember that once you have the camshaft in place, you must turn the crankshaft one full turn. The distributor can then be installed to the #1 cylinder. At this point, the marks on the cam gear and crank gear should be in the twelve o'clock position.

CAM PHASER LIMITER KITS *(Patent 8,291,876 B2)*

Cam phasers are specially designed, computer-controlled cam gears that automatically optimize camshaft timing based on the current engine RPM and are currently used in all 2008+ Chrysler 5.7-6.4L VVT (Variable Valve Timing), 2005+ Ford Modular 3V, 2011+ Ford 5.0L DOHC Modular 4V V8 Ti-VCT (Variable Cam Timing) and 2007+ GM Gen IV VVT engines. Engine oil is pressure-fed to the phasers through passageways in the cylinder heads and cams. The engine computers control solenoids that adjust this oil flow into and out of the phasers' control chambers, creating the ability to retard the cams.

While this technology provides fuel efficiency and the ability to always be in the best position for maximum power, regardless of engine RPM, it does present some limitations when it comes to performance cams. With such a wide range of valve timing movement, there is very little piston to valve clearance, which limits you to small cam profiles with little overlap.

The COMP Cams® Cam Phaser Limiter Kits for the Chrysler Hemi, Ford Modular 3V and GM Gen IV VVT engines restrict the range of cam timing movement (14° for Chrysler, 20° for Ford and 22° for GM), thus providing the necessary valve clearance for serious performance cams with tighter lobe separations – all while utilizing the benefits of VVT technology. The Cam Phaser Limiters for the 2011+ Ford 5.0L 4V Ti-VCT engine limit the cam phasing to 25 crank degrees (12.5 cam degrees) while the cam phaser locks for that same engine allow fully adjustable locking over the OEM phaser range (50°).

The resulting upper-RPM gains from using COMP Cams® Cam Phaser Limiters or Locks are some of the largest we've ever seen from a camshaft swap without sacrificing any bottom end or mid-range performance.

MAKE	DESCRIPTION	PART #
Chrysler	Chrysler Hemi Phaser Lock Kit	5760
	Chrysler Hemi Phaser Limiter Kit	5761
Ford	4.6L/5.4L Modular 3V Ford 2005+ Cam Phaser Limiter Kit	5449
	4.6L/5.4L Modular 3V Ford 2005+ Cam Phaser Limiter Tool	5446
	4.6L/5.4L Modular 3V Ford 2005+ Cam Phaser Limiter Spring Compressor	5447
	4.6L/5.4L Modular 3V Ford 2005+ Cam Phaser Limiter	5448
	5.0L DOHC Modular 4V V8 Ford 2011+ Adjustable Phaser Locks	5492
	5.0L DOHC Modular 4V V8 Ford 2011+ Adjustable Phaser Limiters	5493
GM LS	GM Gen IV 2007-08 Cam Phaser Limiter Kit	5456
	GM Gen IV 2007-08 Cam Phaser Limiter Tool	5454
	GM Gen IV 2007-08 Cam Phaser Limiter Spring Lock Tool	5455
	GM Gen IV 2007-08 Cam Phaser Limiter Plug	5457
	GM Gen IV 2009-Present Cam Phaser Limiter Kit	5460
	GM Gen IV 2009-Present Cam Phaser Limiter Tool	5454
	GM Gen IV 2009-Present Cam Phaser Limiter Spring Lock Tool	5455
	GM Gen IV 2009-Present Cam Phaser Limiter Plug	5459

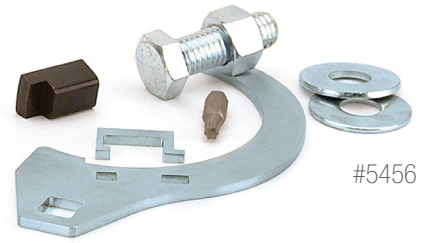

#5456

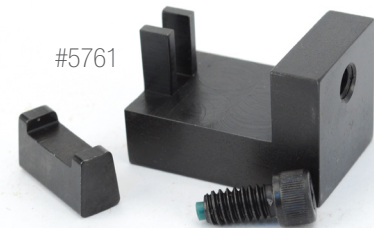

#5761



#5448

FORD 4.6/5.4L SOHC AND DOHC ADJUSTABLE CAM GEAR SET

Ford's 4.6/5.4L Two and Four Valve engines have the capacity to make huge horsepower, but with the factory timing gear setup, you can't "tune" your camshaft timing. The COMP Cams® Ford 4.6/5.4L SOHC and DOHC Adjustable Cam Gear Set provides up to 12° of camshaft advance or retard. This ability to adjust the cam timing is important when performance engine modifications are completed. The cam gear set installs in exactly the same way as the original factory gears (already equipped with the proper sensor) and work with the Ford OE timing chains. Each gear features both a steel hub and steel outer gear for heightened durability and light weight.

DESCRIPTION	PART #
4.6/5.4L SOHC/DOHC Cam Gear Set	10254



#10254

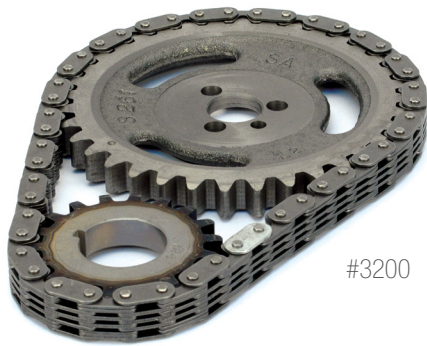

#3200

HIGH ENERGY™ TIMING SETS

- Exceed all original equipment timing chain specifications
- Premium quality link belt type timing chain for exceptional durability; chain available separately
- Precision, cast iron camshaft and crank gear sprockets
- Ideal for stock replacement and mild performance applications

MAKE	DESCRIPTION	TIMING SET PART #	CHAIN ONLY PART #
AMC	V6, 199-258, 1964-97	3219	3319
	V8, 290-401, 1969-81	3218	3318
Buick	Buick, Olds, Pontiac V6, 198-231, 1962-77	3215	3315
	Buick, Olds, Pontiac V6, 183-252, 1977-Up	3226	3326
	V8, 350, 1968-80	3215	3315
Chevrolet	V8, 400-455, 1967-76	3217	3317
	V6 60° 173	3201	3301
	V6 90°, 200, 229, 262, 1978-Present	3200	3300
	V6 90°, 262 (4.3L), 1992-Present w/ Balance Shaft	3202	3300
	V8 265-400, 1955-91 (Except w/ Factory Roller Cam)	3200	3300
Chrysler	V8 350 LT1 1995-Up	3207	3307
	V8 396-454, 1965-91 & Early Style Roller 502 Gen V	3210	3310
	6 Cyl. 170-225, 1960-87	3205	3305
Ford	V8 273-360, 1956-88	3203	3303
	V8 383-440 (Single-Bolt Gear), 1956-79	3204	3304
	V6 144-200, 1960-83	3223	3323
	V6 171 (2600-2800), 1972-80	3236	—
	V8 289-351W & Boss 302, Pre-1972	3220 ¹	3320
	V8 302-351W, 1972-Up	3230 ²	3330
Oldsmobile	V8 351C, 351M, 400M, 1970-82	3221	3321
	V8 352-428, 1964-74	3208	3308
	V8 429-460, 1968-71	3222 ¹	3322
Pontiac	V8 260-455, 1965-83	3213	3313
Pontiac	V8 265-455, 1955-81	3212	3312

¹ Accommodates one-piece fuel pump eccentric

² Accommodates two-piece fuel pump eccentric

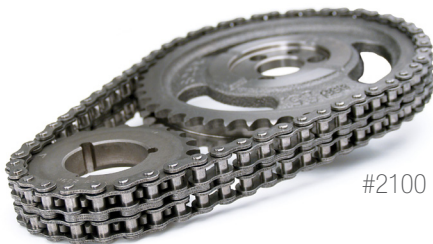

#2100

MAGNUM DOUBLE ROW TIMING SETS

- Induction hardened cast iron camshaft gear & billet steel crank sprocket
- Features 3 keyway crank sprocket for 4-degree incremental adjustability, 4-degree maximum advance/retard
- Heavy-duty, heat-treated double row timing chain; chain available separately
- Ideal for mild street performance

MAKE	DESCRIPTION	TIMING SET PART #	CHAIN ONLY PART #
AMC	V8 290-401, 1969-81	2118	2041
Cadillac	368, 425, 472, 500 V8, 1968-84	2139 ¹	N/A
Chevrolet	V6 90°, 200, 229, 262, 1978-86	2100	2001
	V6 (4.3L) 262, 1987-92 w/ Factory Roller Cam	2136	2001
	V8 & 90° V6, V8 305-350 1987-90 w/ Factory Roller Cam	2136	2001
	V8 265-400, 1955-91 (Except w/ Factory Roller Cam)	2100	2001
	V8 396-454, 1965-91	2110	2023
Chrysler	V8 273-360, 1956-88	2103	2007
	V8 383-440 (Single-Bolt Gear), 1956-79	2104	2009
	V8 426 Hemi, 383-440 (Three-Bolt Gear) 1960-73	2109	2009
Ford	V8 255, 289, 302 & Boss 302, 1965-88	2120 ²	2002
	V8 5.0L 302 H.O., 1980 through 3/21/84	2131	2002
	V8 5.0L, 302, 351W 3/22/84 through 1992	2138 ³	2002
	V8 351W, 351W 1969-84	2135 ³	2002
	V8 351C, 351M, 400M, 1970-82	2121	2015
	V8 352-428, 1964-74	2108	2015
Oldsmobile	V8 429-460, 1968-71	2122 ²	2009
	V8 429-460, 1972-87	2130 ²	2009
	429-460 w/ 9 Keyway Crank Gear	2134 ⁴	2024
Pontiac	V8 260-455, 1965-83	2113	2015
Pontiac	V8 326-455, 1955-81	2112	2025

¹ Uses a single roller timing chain, not double roller ³ Accommodates two-piece fuel pump eccentric

² Accommodates one-piece fuel pump eccentric ⁴ Uses a link belt type timing chain, not double roller

HI-TECH™ ROLLER RACE TIMING SETS

- Cast iron camshaft gear and induction hardened billet steel crank sprocket
- Dynamically balanced and quality checked for run-out tolerances
- Features 3 keyway crank sprocket for 4-degree incremental adjustability, 4-degree maximum advance/retard
- Ideal for all street performance and race applications
- Pre-stretched, heat-treated true double roller chain with heavy-duty large pin design; chain available separately

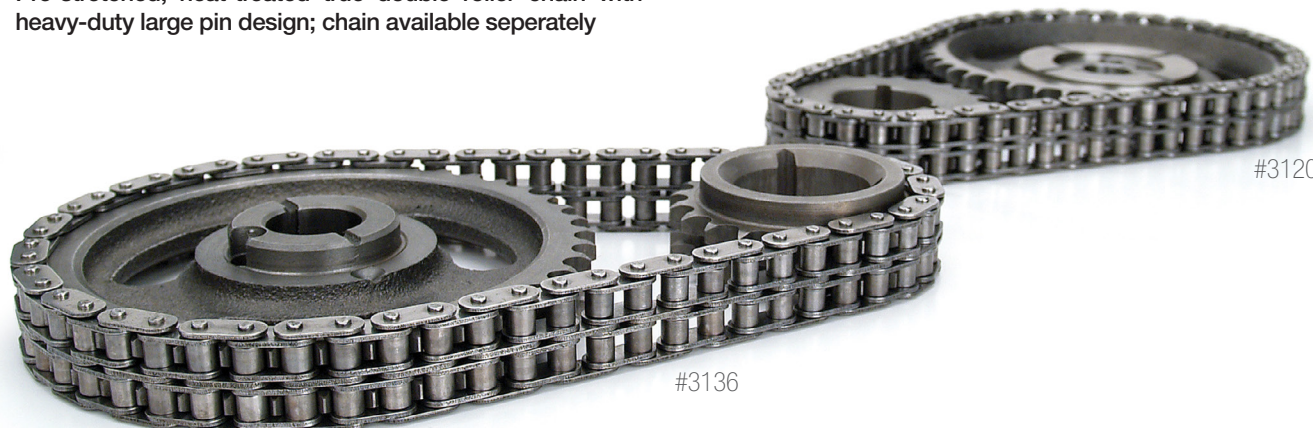

MAKE	DESCRIPTION	TIMING SET PART #	CHAIN ONLY PART #
AMC	V6 199-258, 1964-86	3127	3033
	V8 290-401, 1969-81	3118	3032
Buick	Buick, Olds, Pontiac V6, 183-252, 1977-Up	3129	3036
	Buick, Olds, Pontiac V6, 198-231, 1962-77	3128	3036
	V8 350, 1968-80	3128	3036
Chevrolet	V6 90°, 200, 229, 262, 1978-86	3100	3030
	V8 4.3L V6 262, 1987-92 w/ Factory Roller Cam	3136	3030
	V8 265-400, 1955-91 (Except w/ Factory Roller Cam)	3100	3030
	V8 265-400 True Roller Race Set .005" Undersized for Align Bored Blocks	3100-5 ¹	3037
	V8 265-400 True Roller Race Set .010" Undersized for Align Bored Blocks	3100-10 ¹	3037
	V8 305-350, 1987-92, w/ Factory Roller Cam (Non-LT1)	3136	3030
	V8 348, 409, 1958-65	3101	3033
	V8 396-454, 1965-96	3110	3034
	V8 396-454 True Roller Race Set .005" Undersized for Align Bored Blocks	3110-5 ¹	3038
V8 396-454 True Roller Race Set .010" Undersized for Align Bored Blocks	3110-10 ¹	3038	
Chrysler	V8 273-360, 1956-88	3103	3035
	V8 383-440 (Single-Bolt Gear), 1956-79	3104	3034
	V8 426 Hemi, 383-440 (Three-Bolt Gear), 1960-73	3125	3034
Ford	V8 255, 289, 302 & Boss 302, 1965-88	3120 ²	3038
	V8 5.0L H.O. 302, 1980 thru 3/21/84	3131	3030
	V8 5.0L 302, 351W from 3/22/84 thru 1992	3138 ³	3030
	V8 351W, 351W H.O. 1969-84	3135 ³	3030
	V8 351C, 351M, 400M, 1970-82	3121	3033
	V8 V8, 352-428, 1963-76	3108	3033
	V8 429-460, 1968-71	3122 ²	3034
V8 429-460, 1972-87	3130 ²	3034	
Oldsmobile	V8 260-455, 1965-83	3113	3033
Pontiac	V8 326-455, 1955-82	3112	3031

¹ Undersized for align bored blocks

² Can be used on late model engines but requires one-piece fuel pump eccentric

³ Accommodates two-piece fuel pump eccentric



ADJUSTABLE TIMING SETS

- Include durable, induction hardened steel billet gears
- Feature infinitely adjustable camshaft sprocket, 6-degree maximum advance/retard
- 3 Keyway crank sprocket for additional 4-degree incremental adjustability
- Pre-stretched, heat-treated double roller chain with heavy-duty large pin design; chain available separately
- Torrington roller thrust bearing for reduced friction
- Ideal for all street performance and race applications



KEYWAY ADJUSTABLE BILLET TIMING SETS

- Induction hardened and precision machined, steel billet gears for bullet proof durability
- Features 9 keyway crank sprocket for 2-degree incremental adjustability, 8-degree maximum advance/retard
- Pre-stretched, heat-treated double roller chain w/ heavy-duty large pin design
- Includes Torrington roller thrust bearing for reduced friction
- Ideal for all street performance and race applications

MAKE	DESCRIPTION	TIMING SET PART #	CHAIN ONLY PART #
Chevrolet	V8 265-400 Adjustable Timing Set w/ Thrust Bearing	3100KT	3037
	V8 265-400 Adjustable Timing Set w/ Thrust Bearing .005" Undersized	3100KT-5 ¹	3037
	V8 265-400 Adjustable Timing Set w/ Thrust Bearing .010" Undersized	3100KT-10 ¹	3037
	V8 SBC/Olds Rocket Block, Raised Cam	3146KT	3046
	V8 396-454 Adjustable Timing Set w/ Thrust Bearing	3110KT2	3038
	V8 396-454 Adjustable Timing Set w/ Thrust Bearing .005" Undersized	3110KT-5 ¹	3038
	V8 396-454 Adjustable Timing Set w/ Thrust Bearing .010" Undersized	3110KT-10 ¹	3038
	V8 454-502, Gen VI Adjustable Timing Set	3149KT ^{3,7}	3049
GM LS	LS Single Chain Hex Adjust Type for 3 Bolt Cam, 1 Pole Reluctor (24x)	3158KT ⁴	—
	LS Single Chain Hex Adjust Type for 3 Bolt Cam, 4 Pole Reluctor (58x)	3172KT	—
	LS7 Single Chain Hex Adjust Type for 3 Bolt Cam, 4 Pole Reluctor (58x)	3167KT	—
Chrysler	V8 383-440 Three-Bolt Adjustable Timing Set	3125KT	3038
Ford	V8 5.0L, 302, 351W Adjustable Timing Set	3135KT	3037
	V8 390-428 Adjustable Timing Set	3108KT	3008
	V8 429-460 Adjustable Timing Set	3121KT ⁵	3038
Oldsmobile	V8 400-455 Adjustable Timing Set	3113KT ⁶	3008
	V8 Rocket Block, Raised Cam	3146KT	3046
ACCESSORIES			
—	Replacement Bushings for Adjustable Timing Sets	9005	—

¹ Accommodates one-piece fuel pump eccentric

² Accommodates two-piece fuel pump eccentric

³ Single roller chain design for clearance

⁴ Sold as complete matched sets only

⁵ Includes one-piece fuel pump eccentric

⁶ Not to be used where open spring pressures exceed 500 lbs

⁷ Bearing NOT included or required

MAKE	DESCRIPTION	PART #
Chevrolet	V8 265-400	7100
	V8 265-400 .005" Undersized for Align Bored Blocks	7100-5 ¹
	V8 265-400 .010" Undersized for Align Bored Blocks	7100-10 ¹
	V8 305-350 w/ Factory Roller Cam	7136
	V8 396-454	7110
	V8 396-454 .005" Undersized for Align Bored Blocks	7110-5 ¹
	V8 396-454 .010" Undersized for Align Bored Blocks	7110-10 ¹
	V8 454-502 Gen VI 1996-02	7101
GM LS	LS (58x) Single Chain 9 Keyway (Single-Bolt Gear, 4 Pole Reluctor)	7107
	Gen III LS2 (Early Model w/ 24 Tooth Reluctor Only)	7102
	LS2 (Single-Bolt)	7105
	LS3 (58x) 9 Keyway (Three-Bolt Gear, 4 Pole Reluctor)	7106
Chrysler	V8 273-360 (Single-Bolt)	7103
	V8 383-440 (Single-Bolt)	7104
	V8 426 Hemi, 383-440 (Three-Bolt Gear), 1960-73	7125
	V8 5.7L, 6.1L Hemi, 2005-08	7114
Ford	V8 289-351 W, 1965-88	7138
	V8 1965-88, .005" Undersized	7138-5 ¹
	V8 1965-88, .010" Undersized	7138-10 ¹
	V8 352-428	7108
	V8 429-460	7122 ²
Pontiac	V8 326-455	7112
	V8 326-455 .005" Undersized	7112-5 ¹

¹ Undersized for align bored blocks

² Must be used with one-piece fuel pump eccentric

ULTIMATE ADJUSTABLE BILLET TIMING SETS

- High-strength billet gears & seamless roller chain deliver years of service
- 2-Degree incremental adjustability, 6-degree maximum advance/retard
- Unique design yields precise camshaft timing and durability
- Includes Torrington roller thrust bearing for reduced friction and custom adjusting tool
- Ideal for all street performance and race applications

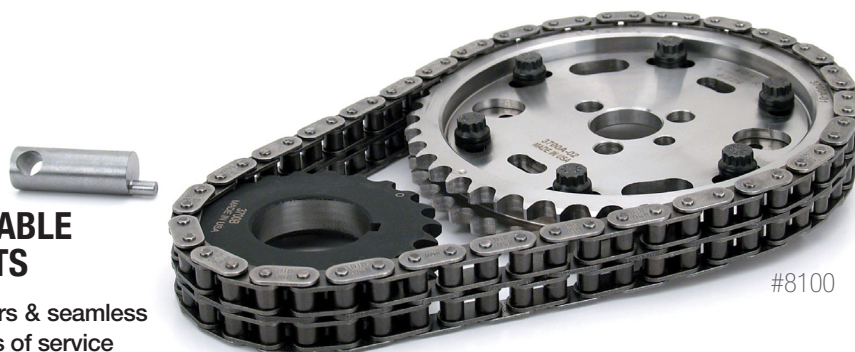

MAKE	DESCRIPTION	PART #
Chevrolet	V6 90°, 200, 229, 262, 1978-86	8100
	V8 265-400, 1955-91 (Except w/ Factory Roller Cam)	8100
	V8 SBC/Olds Rocket Block, Raised Cam Blocks	8146
	V8 396-454, 1965-96	8110
Ford	V8 5.0L 302, 351W from 3/22/84 thru 1992	8138 ¹
	V8 5.0L 302, 351W	8131 ²
	V8 429, Boss 429-460	8122 ²

¹ Accommodates two-piece fuel pump eccentric

² Accommodates one-piece fuel pump eccentric

GM LS TIMING SETS FOR RHS®/LSX™ RAISED CAM BLOCKS

- Engineered for use with cam blocks raised .388" above stock, which includes the popular RHS® LS Race Block
- Premium chain with unmatched strength and durability for extreme race applications
- Available in a wide variety of options, including 3 keyway, 9 keyway or Hex Adjust; 1 or 4 pole reluctors; and 1- or 3-bolt cam cores

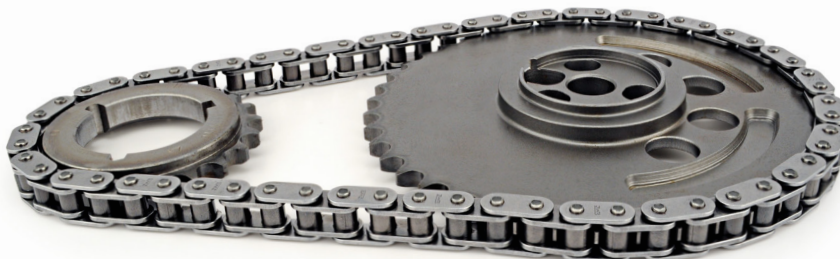

DESCRIPTION	PART #
LS Single Chain Hex Adjust Type for 3-Bolt Cam, 1 Pole Reluctor (24x)	9158KT
LS Single Chain Hex Adjust Type for 3-Bolt Cam, 4 Pole Reluctor (58x)	9172KT
LS Single Chain 3 Keyway for 1-Bolt Cam, 4 Pole Reluctor (58x)	9673T3
LS Single Chain 3 Keyway for 3-Bolt Cam, 1 Pole Reluctor (24x)	9658T3
LS Single Chain 3 Keyway for 3-Bolt Cam, 4 Pole Reluctor (58x)	9672T3
LS Single Chain 9 Keyway for 1-Bolt Cam, 4 Pole Reluctor (58x)	9673T9
LS Single Chain 9 Keyway for 3-Bolt Cam, 1 Pole Reluctor (24x)	9658T9
LS Single Chain 9 Keyway for 3-Bolt Cam, 4 Pole Reluctor (58x)	9672T9
LS Double Chain Hex Adjust Type for 3-Bolt Cam, 1 Pole Reluctor (24x)	3173KT
LS Double Chain 3 Keyway for 3-Bolt Cam, 1 Pole Reluctor (24x)	3154
LS7 Single Chain Hex Adjust Type for 3-Bolt Cam, 4-Pole Reluctor (58x), One-Piece Oil Cog w/ Gear	9167KT
LS7 Single Chain 3 Keyway for 3-Bolt Cam, 4-Pole Reluctor (58x)	9667T3
ACCESSORIES	
LS Replacement Single Chain	9302
LS Replacement Double Chain	9132

BILLET GM LS BELT TENSIONERS

The GM LS engines with the factory spring loaded belt tensioners become prone to throwing belts when used in performance applications and with aftermarket balancers. These bolt-on Billet LS Belt Tensioners are a fully adjustable solution for controlling potentially damaging resonance and maintaining desired belt tension.

DESCRIPTION	PART #
Billet GM LS1, -2, -3, -6 & -7 Adjustable Belt Tensioner w/ Idler Pulley Passenger Cars	54021 ^{1,2}
Billet GM LS1 Adjustable Belt Tensioner, 1998-02 F-Body	54025

¹ Will not work in truck engines

² If used with 2010+ Camaros, belt must be changed



GEAR DRIVES

- Precision-machined, heat-treated billet steel gears for timing accuracy & durability
- Unique design virtually eliminates timing movement throughout the RPM range
- Complete ready-to-install kit, including bolts and lock plate, ideal for street performance applications that desire whining blower sound

MAKE	DESCRIPTION	PART #
Chevrolet	Small Block Gear Drive System	4100 ¹
	V8 305, 350 w/ Factory Roller Cam Gear Drive System	4136 ^{1,2}
	Big Block Gear Drive System	4110
Ford	Small Block Gear Drive System	4120
ACCESSORIES		
-	Replacement Brass Washer for #4100 Gear Drive System	4100BW
-	Replacement Brass Washer for #4110 Gear Drive System	4110BW

¹ OE Roller Blocks must counter sync bolts

² Not for use in LT1 engines

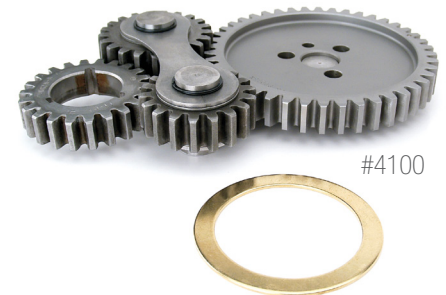

GEAR SETS

- Precision-hobbed and crown-shaved aluminum, steel and fiber gears
- Quality tested for strict tolerances and timing accuracy

MAKE	DESCRIPTION	PART #
Chevrolet	Chevrolet/GMC 4 & 6 Cyl. 153, 194, 230, 250, 292, 1962-88 (Aluminum Cam Gear)	3211 ¹
	Chevrolet/GMC 4 & 6 Cyl. 153, 194, 230, 250, 292, 1962-88 (Fiber Cam Gear)	3161 ¹
Ford	V6 240-300, 1965-91 (Steel Gears)	3224
	V6 2800cc	3236
International Harvester	V8 304-392 (Steel Cam Gear)	3225
Pontiac	4 Cyl., 151c.i. Iron Duke (Fiber Cam Gear)	3252

¹ Fine tooth gear

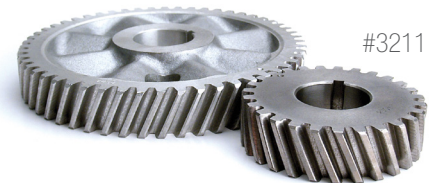

SPRINT CAR FRONT DRIVE KIT FOR LS ENGINES

The COMP Cams® Sprint Car Front Drive Kit for LS Engines bolts to RHS® LS Race, other aftermarket and GM LS blocks with no modifications necessary. It is the first and only fully engineered, bolt-on assembly that provides a proper and reliable solution for cam thrust bearings, distributor/magneto, oil pump, water pump, camshaft/crank sensors and gear drive. Designed and proven for racing duty, the unique piece also features oil passages that provide oiling directly to gears and bearings.

DESCRIPTION	PART #
LS Sprint Car Front Drive Kit for RHS®	5490
LS Sprint Car Front Drive Kit for GM	5491



*All necessary hardware included.

MAGNUM BELT DRIVE SYSTEMS

- Absorb crankshaft harmonics to guard against valve train instability
- Infinitely adjustable camshaft sprocket for absolute timing accuracy
- High-strength belt for increased durability over any chain or gear drive
- Available for internal (wet) applications and external (dry) applications
- Ideal for all street performance and budget-minded race applications

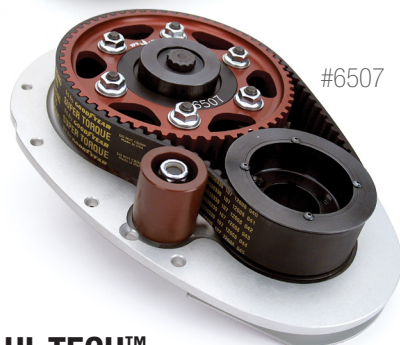

HI-TECH™ BELT DRIVE SYSTEMS

- Extreme application belt for high RPM and high compression durability
- Infinitely adjustable Vernier sprocket for absolute timing accuracy
- Unique belt idler system to reduce flap throughout RPM range
- Designed to absorb crankshaft harmonics to guard against performance-robbing valve train instability
- Utilizes a unique camshaft thrust adjustment system without shims
- Includes double lip seals for long life and maximum crankcase vacuum
- Different diameter idlers available for racers with align bored blocks
- Ideal for serious street performance and race applications

DESCRIPTION	PART #
Chevrolet Small Block Wet System	5100
Chevrolet Small Block Dry System	6100 ¹
ACCESSORIES	
Replacement Belt for #5100	5000B
Crank Spacer .010" Thick for #5100	5100CR ¹
Replacement Cam Button for #5100	211
Replacement Belt for #6100 (72-Tooth)	6100B
Seal Kit for #6100	6100SP
Upper Replacement Oil Seal for #6100	6100US
Lower Replacement Oil Seal for #6100	6100LS
Cam Gear Bolt (LH Thread) for #6100	6100LHB
Retainer Washer (Cam Gear) for #6100	6100RW
Bronze Shim for #6100 (Upper Gear to Cam Adapter)	6100BS
Bronze Shim for #6100 (Cam Adapter to Block)	6100BSC

¹ Fitment to the World Products Motown Block requires extensive machining to the block, oil galley plugs and cover

DESCRIPTION	PART #
Chevrolet Small Block w/ Idler	6500
Chevrolet Small Block w/ Idler, Big Block Crank Snout	6502
Chevrolet Small Block, Olds Rocket, Raised Cam	6504
Chevrolet Small Block, Olds Rocket, Raised Cam Big Block Crank Snout	6506
Chevrolet Small Block Xtreme Duty Hi-Tech™ Belt Drive Features a 1.250" Thick Belt for Extreme Cylinder Pressure	6507
Chevrolet Big Block Belt Drive, Standard Cam Location	6200
Chevrolet Big Block Belt Drive, .400" Raised Cam	6300

DESCRIPTION	PART #
ACCESSORIES	
Timing Belt – 81-Tooth for #6200	6200TB2
Belt Tensioner – Standard for #6200	6200BTS
Belt Tensioner – Oversized for #6200	6200BTO
Upper Cam Seal for #6200 & #6300 (2.770" O.D.)	6200CS-1
Upper Cam Seal for #6200 & #6300 (2.845" O.D.)	6200CS2-1
Lower Crank Seal for #6200	6200CRS-1
Bolt Kit for #6200 & #6300	6200BK
Main Plate Gasket for #6200	6200TG
Upper Seal Retainer O-Ring	6200RO
High Vacuum Seal Kit	6200VS
High Vacuum Cam Seal	6200VCS
High Vacuum Crank Seal	6200VCRS
Belt Drive Distributor Mount Kit & Pulley Adapter Hub (Fits #6200 & #6300)	6200EDSK
Chevrolet 396-454 Roller Thrust Bearing for #6200 & #6300	3110TB
Replacement Belt for #6300 (85-Teeth)	6300B
Replacement Belt for #6500 and #6506 (74-Teeth)	6500B-1
Upper Seal for #6500, #6502, #6504, #6506	6500US-1
Lower Seal for #6500, #6502, #6504, #6506	6500LS-1
Std. Idler Assy. for All #6500 Series Chevy Drives (1.312" O.D.)	6500IDS-1 ¹
O.S. Idler Assy. for All #6500 Series Chevy Drives (1.375" O.D.)	6500IDA-1 ¹
O.S. Idler Assy. for All #6500 Series Chevy Drives (1.437" O.D.)	6500IDB-1 ¹
Replacement Idler Bearing	6500IB-1
Distributor Bracket for #6500, #6502, #6504 & #6506	6500EDSK
Upper Seal for #6500, #6502, #6504, #6506	6500US-1
Replacement Belt for #6504 & #6506 (75-Teeth)	6504B-1
Replacement Belt for #6507 (74-Teeth)	6507B
Replacement Belt for #6535 (74-Teeth)	6535B
Upper Cam Seal for #6535	6535US
Lower Crank Seal for #6535	6535LS
Cam Seal Cover for #6535	6535CS
Cam Seal Cover O-Ring for #6535	6535CSO
Mounting Bracket for Mechanical Fuel Pump for #6535	6535MBMP

¹ Includes bearings and snap ring

CHEVROLET STEEL TIMING COVER WITH THRUST PLATE

This steel Small Block Chevrolet timing cover features a welded thrust plate tab for use with a cam button. It allows adjustment for correct end play without additional modifications and includes gaskets, seal and bolts and has a black powder coated finish.

DESCRIPTION	PART #
Chevrolet 265-400 Steel Timing Cover w/ Welded Thrust Plate	208



CHEVROLET TWO-PIECE BILLET ALUMINUM TIMING COVERS

- Eliminates timing cover flex which causes erratic ignition timing
- Allow cam to be replaced without disturbing oil pan seal
- Simple endplay adjustment with dial indicator access hole
- Integrated timing pointer simplifies ignition timing checks
- Compatible with all water pumps and most gear drives

DESCRIPTION	PART #
Chevrolet Small Block & 90° V6	210 ¹
Chevrolet Big Block Timing Cover	212 ¹
Chevrolet Gen VI Big Block Timing Cover (Allows Use Of Early Style Camshafts & Double Row Timing Sets)	217
ACCESSORIES	
Replacement Button for #210 & #212 Covers	211
Replacement Hardware for #210	213
Replacement Hardware for #212	214
Timing Cover Gasket for #217	218

¹ Includes bolts, washers, roller button gaskets, etc.



CHEVROLET THREE-PIECE BILLET ALUMINUM TIMING COVERS

The COMP Cams® Three-Piece Billet Aluminum Timing Covers for Small and Big Block Chevrolet engines allow access to camshaft timing adjustments without having to remove the harmonic damper or disturb the oil pan seal. Designed to be lightweight yet rigid, these billet covers offer convenience and performance in one easy-to-install package.

DESCRIPTION	PART #
Chevrolet Small Block & 90° V6 Three-Piece Cover	310
Chevrolet Big Block Three-Piece Cover	312

Note: Three-piece covers use the same replacement hardware kits as our current two-piece covers.



GM LS FRONT COVERS

The COMP Cams® LS Front Covers for street/strip applications fit all LS1, -2, -3, -6 or LS7 engines, OEM and aftermarket, including the RHS® LS Race Block. The LS Covers feature provisions for timing pointer, OEM camshaft sensor and any regular BBC crank trigger. Available for either standard snout (LS1/6) or long snout (LS7) crankshafts, the covers easily fit double roller timing chains and high pressure/volume oil pumps. Both covers come with gasket and crank seal; no modifications needed.

DESCRIPTION	PART #
LS Front Cover (LS1, -2, -3, -6)	5496
LS Front Cover (LS7)	5497





#3100TB-1

THRUST BEARINGS & WEAR PLATES

- Wear plates are moly coated
- Eliminates wear at front of block
- Unique designs help set proper cam thrust clearance



#202

THRUST BUTTONS

- Rides between the front of the timing gear and the back of the timing cover
- Can be shimmed for proper endplay
- Solid nylon and roller thrust bearing styles available

MAKE	DESCRIPTION	BEARING THICKNESS	PART #
Chevrolet	V8 265-400 Wear Plate	.030"	201 ¹
	V8 396-454 Wear Plate	.030"	203 ¹
	V8 265-400 Roller Thrust Bearing	.142"	3100TB-1 ¹
	V8 396-454 Roller Thrust Bearing	.142"	3110TB ¹
GM LS	GM LS 3-Bolt Cam Retaining Kit	N/A	5463-KIT
	Factory GM LS Bronze Thrust Kit	N/A	5400TP-KIT
Chrysler	V8 383-440 Hemi Wear Plate	.030"	203 ¹
Ford	V8 289-351W Thrust Plate & Bearings OEM Replacement for Cam Plate Single Bearing	.142"	3120TB
	V8 289-351W H.P. Thrust Plate & Bearings, Machining Required	.142"	3135TB ²
	V8 390-428 Thrust Plate & Bearings	.142"	3108TB ¹
	V8 351C, 429-460 Thrust Plate & Bearings	.142"	3122TB ¹
Oldsmobile	V8 All 1964-84 Except Diesel	.400"	224
	V8 Camshaft Spacer (Required w/ 224)	.041"	225

¹ Minor machining required when used with OEM type timing set

² Requires tooling

MAKE	DESCRIPTION	LENGTH	PART #
Buick	V6 1977 1/2-87 Roller Button	.660"	269
Chevrolet	V8 265-400, 90° V6 Nylon Thrust Button	.810"	202
	V8 265-400 Roller Button	.795"	200
	V8 396-454 Nylon Thrust Button	.945"	205
	V8 396-454 Roller Nylon Thrust Button For Part #2110	.945"	261
	V8 396-454 Roller Button	.945"	207
Chrysler	V8 Hemi Roller Buttons	.715"	204
	V8 Hemi, 383-440 Nylon Thrust Button	.735"	206

ACCESSORIES

-	Replacement Button for #210 & #212 Covers, Replacement Button for #5100 Belt Drive	.680"	211
---	--	-------	-----



DEGREE BUSHINGS

- Color coded for easy identification
- Accurately positions cam
- Requires a 13/32" drill set
- Fit Small & Big Block Chevrolets, Big Block & 426 Hemi Chrysler



CAM LOCK PLATES

- Prevent cam bolts from backing out at any RPM or load
- Feature bendable locking tabs & special high-strength bolts



CAMSHAFT BOLTS

- Designed to prevent breakage
- Rated at 170,000psi

DESCRIPTION	BUSHINGS	PART #
Cam Degree Bushing Set (Includes 0°, 2°, 4°, 6°, 8°)	All	4760
Cam Degree Bushing 5 Pack – Black	0°	47600
Cam Degree Bushing 5 Pack – Silver	2°	47602
Cam Degree Bushing 5 Pack – Copper	4°	47604
Cam Degree Bushing 5 Pack – Gold	6°	47606
Cam Degree Bushing 5 Pack – Dark Grey	8°	47608
ACCESSORIES		
Replacement Hex-Shaped Bushings for Adjustable Timing Set	-	9005

MAKE	DESCRIPTION	PART #
Chevrolet	V8 Lock Plate w/ Bolts	4605
GM LS	Gen III/IV LS 3-Bolt Style Lock Plate w/ Bolts	5461

MAKE	DESCRIPTION	SIZE	LENGTH	PART #
Chevrolet	V8 & 90° V6 Cam Bolts	5/16"	.750"	4611-3
GM LS	L92 Cam Installation Bolt	M16	1.50"	5458
Ford	V8 260-351W Cam Bolts	3/8"	1.50"	4612-1
	V8 351C Cam Bolts	3/8"	2.00"	4613-1
	V8 352-427 Cam Bolts	7/16"	1.75"	4615-1
	V8 429-460 Cam Bolts	3/8"	1.50"	4614-1

COMPOSITE COATED CAM BEARING

- Retain engine oil on surface under extreme heat & pressure
- Fluoropolymer coating is a lubricant itself, which is excellent protection in the event of momentary oil starvation, such as during start-up

DESCRIPTION	PART #
Composite Coated 2.124" Big Block Camshaft Bearing	3521



ROLLER CAM BEARINGS

- Decrease friction and control oil closely
- Steel jacketed and encapsulated for ease of installation

DESCRIPTION	JOURNALS 1-4	JOURNAL 5	PART #
351 SVO Journal Diameter	3500RCB 2.165"	3501RCB 1.968"	351RCB-KIT
350 Chevrolet/360 Chrysler Journal Diameter	3501RCB 1.968"	3502RCB 1.968"	350RCB-KIT



ROLLER CAM BEARING INSTALLATION TOOL

The COMP Cams® Roller Cam Bearing Installation Tool is the tool of choice for many professional engine builders. This tool allows roller cam bearings to be professionally installed in most engine blocks. The kit includes a draw bar, swivel handle, alignment head and a 50mm bearing head. Other bearing heads are available separately.

DESCRIPTION	PART #
Cam Bearing Tool w/ 50mm Head	5412
Additional 47.64mm Needle Bearing Head	5413
Additional 50mm Needle Bearing Head	5414
Additional 55mm Needle Bearing Head	5415
Additional 60mm Needle Bearing Head	5416



UNIVERSAL CAM BEARING INSTALLATION KIT

- Cleanly and precisely installs or removes cam bearings in any engine block
- Ranges from 1.125" to 2.690" journal diameter
- Kit includes five expanding neoprene-covered mandrels, a centering cone, extension rod and fitted plastic case

DESCRIPTION	PART #
Universal Cam Bearing Installation Kit	5312



BEARING SPACER

These bearing spacers allow 350 Chevrolet crankshafts to be installed into 400 Chevrolet blocks. Absolutely no machine work is required for installation; simply snap them in and install standard 350 bearings. You save the cost of buying thicker, more expensive bearings.

DESCRIPTION	PART #
Chevrolet V8 Bearing Spacer Set	5620



DIE CAST ALUMINUM VALVE COVERS

Manufactured and packaged in the U.S.A., this line of powder coated die cast aluminum valve covers will provide a sleek, high-performance look combined with rigid durability and unmatched reliability. They are a perfect addition to any high-performance engine. These valve covers are perimeter bolt style and include two chrome breathers with laser etched logos, two black rubber grommets and installed baffles. The installed baffles are welded in place to ensure no oil enters the breathers. The chrome breathers are present on both valve covers which allows for proper crankcase ventilation. In addition, these covers were designed to be tall enough to provide the necessary clearance to accommodate aftermarket valve trains. The line currently includes applications for Small Block Chevy, Big Block Chevy and Small Block Ford engines. Gaskets are not included.

- Die cast aluminum with black-wrinkle powder coated finish
- Include chrome breathers with laser etched logos, rubber grommets and installed baffles
- Welded-in baffles prevent oil from entering breathers
- Taller height provides clearance for aftermarket valve trains

ENGINE COIL COVERS FOR FORD 5.0L COYOTE ENGINES

- Die cast aluminum offers rigid durability & unmatched reliability required for performance applications
- Black-wrinkle powder coated for a sleek, high-performance look that resists corrosion
- Fits Mustang, truck & 5.0 Coyote crate engine applications, as well as aftermarket valve train



#233

ENGINE FINISHING KITS

It's easy to overlook the small details. For engine builders focused on the larger components like camshafts, cylinder heads and pistons, small parts are often forgotten until the final stages of engine assembly. COMP Cams® Engine Finishing Kits include those often missing parts like wood-ruff keys, cylinder head alignment dowels, cam bolts, cam eccentrics (SB Ford) and timing cover and oil pump dowel pins that are so crucial to properly assembling your engine.

Engine finishing kits are available for Small and Big Block Chevrolets, Small and Big Block Fords, as well as several other applications.



#282

MAKE	DESCRIPTION	PART #
Chevrolet	V8 265-400 Aluminum Valve Covers	280
	V8 265-400 Aluminum Valve Covers (Dual Breather Circle Track Version)	283
	V8 396-454 Aluminum Valve Covers	281
Ford	V8 221-302-351W Aluminum Valve Covers	282
ACCESSORIES		
-	SBC Valve Cover Adapter Kit for GM LS Engines	NG4011
-	Replacement Breather For #280, #281, & #282	284



#288

DESCRIPTION	PART #
Engine Coil Covers for Ford 5.0L Coyote Engines	288

MAKE	DESCRIPTION	PART #
AMC	6 Cyl. 199-258 4.0L Finishing Kit	239
Chevrolet	V8 265-400 Engine Finishing Kit	233
	V8 LT1 Engine Finishing Kit	242
	V8 396-454 Engine Finishing Kit	234
GM	LS Engine Plug Kit	251
Chrysler	V8 1964-05 V8 273-360 Engine Finishing Kit	241
Ford	V8 5.0L Engine Finishing Kit	243
	V8 5.0L, 302, 351W Engine Finishing Kit	235
	V8 FE 1958-1976 Engine Finishing Kit	244
	V8 FF 1968-1987 Engine Finishing Kit	245
	V8 FF 1988-1997 Engine Finishing Kit	247
Pontiac	V8 Engine Hardware Finishing Kit	238

Note: Kit contents may vary by application, call for specific kit contents before ordering.

VACUUM CANISTERS

A vacuum reserve canister captures an extra shot of vacuum from your engine for your power brakes. The COMP Cams® Vacuum Canisters are for cars equipped with big cams and power brakes. COMP Cams® Electric Pump Kit ensures your vacuum stays between 18" and 2".

- Canisters double vacuum volume for power brakes
- Recommended for vehicles with 14" of vacuum or less
- Electric vacuum pump requires a 12V negative ground systems
- Pump only operates when vacuum drops below 18"

DESCRIPTION	PART #
Electric Vacuum Pump Kit	5500
Vacuum Canister – Black Powder Coated Aluminum	5200
Vacuum Canister – Zinc Plated & Polished	5201



OIL RESTRICTORS

When building a high performance engine with a solid or solid roller cam, it is necessary to meter the amount of oil going through the lifters and up to the rocker arms. Too much oil to the top will starve the main and rod bearings and cause engine failure. These oil restrictors are simple and easy-to-use parts.

DESCRIPTION	PART #
V8 Chevrolet Screw-In Type Oil Restrictors – .055" Orifice	4917



LIFTER VALLEY STANDPIPE

It is common practice in engine building to plug the oil drain holes in Small Block Chevrolet engines with standpipes. Usually these are made of pipe and threaded into the holes. COMP Cams® offers a custom extruded aluminum version with an internal hex for installation. It is simple, inexpensive and much easier to use.

DESCRIPTION	PART #
Lifter Valley Standpipe (Set of 8)	4932



FUEL PUMP PUSHRODS

When a high pressure fuel pump is run with a steel roller cam core, the stock fuel pump pushrod is not compatible with the steel core. You can damage an expensive roller cam as a result of wear at the fuel pump lobe. COMP Cams® offers several fuel pump pushrods for various applications.

Note: Bronze tip fuel pump must be used when using a high volume or high pressure fuel pump.

DESCRIPTION	PART #
Lightweight Tubing w/ Bronze Tip for Steel Cams	4607
Steel Rod w/ Roller Tip (Not for BBC)	4609
Lightweight Tubing w/ Steel Tip for Cast Iron Cam	4616
Chrysler Hemi w/ Steel Tip	4626 ¹
Chrysler Hemi w/ Bronze Tip	4646
Oldsmobile Rocket Block w/ Bronze Tip for Steel Cams	4620



¹ For use with cast flat tappet cams only, 3.220" in length.

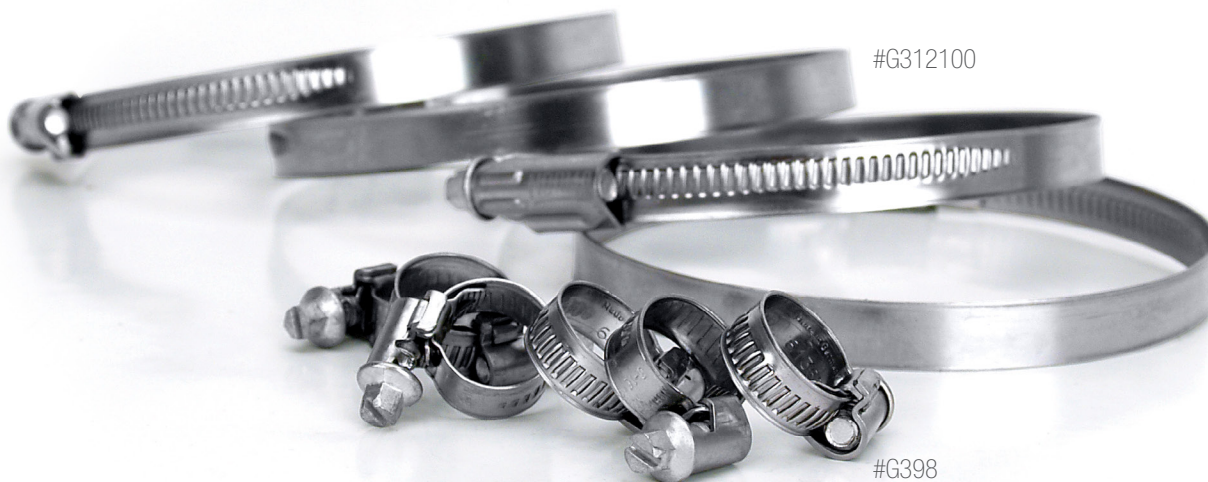

GATOR BRAND™ HOSE CLAMPS

Gator Brand™ Hose Clamps are produced using a continuous stainless steel band with extruded, asymmetrical threads for reliable performance. The edges of the band are rolled to prevent any sharp edges from damaging the hose. This is especially important on silicone hoses that have a soft, vulnerable cover.

An asymmetrical (offset) gear box is employed to reduce clamp twist when tightening. The gear box housing is designed to remain stationary as the clamp is tightened to prevent movement over the hose. The combination of the asymmetrical gear box and the extruded threads provides an even clamping force over the surface of the hose that ensures proper sealing with minimal torque. Gator Brand™ Clamps hold up under 3.7 ft./lbs. (5nm) torque; conventional clamps strip and fail at this torque.

Gator Brand™ Clamps cover a size range of 5/16" (8mm) to 5.000" (120mm) and can be installed using a flat blade screwdriver, metric socket wrench or the Gator Brand™ Flexible Clamp Tool for maximum torque potential.

- Constructed of continuous stainless steel band with extruded, asymmetrical threads
- Asymmetrical (offset) gear box employed to reduce clamp twist when tightening
- Combination of asymmetrical gear box and extruded threads provides even clamping force over surface of hose
- Hold up under 3.7 ft./lbs. (5nm) torque
- Cover size range of 5/16" (8mm) to 5.000" (120mm)

SIZE RANGE (INCHES)	SIZE RANGE (MM)	SAE COMPARABLE SIZE	PART #
.3125"-.500"	8-12	2	G3758
.3125"-.625"	8-16	3	G398
.500"-.875"	12-20	6	G3912
.625"-1.000"	16-25	8	G31216
.750"-1.250"	20-32	10-12	G31220
1.000"-1.625"	25-40	16	G31225
1.1875"-1.750"	30-45	20	G31230
1.250"-2.000"	32-50	24	G31232
1.625"-2.375"	40-60	28	G31240
2.000"-2.750"	50-70	32-36	G31250
2.375"-3.125"	60-80	40	G31260
3.125"-4.000"	80-100	52-56	G31280
4.375"-5.000"	100-120	64	G312100
ACCESSORIES			
Gator Brand™ Flex Tool w/ 6 & 7 Sockets	N/A	N/A	GFT-1

Note: Add -100, -500 or -1000 for bulk purchases.



#4793

CRANKSHAFT SOCKETS

- Specially designed 1/2" drive socket allows rotation of engine assembly
- Knurled retaining nut holds degree wheel in place
- Can be loosened while on crank snout so that wheel can be turned independent of the engine when finding TDC

MAKE	DESCRIPTION	PART #
Chevrolet	Small Block, 90° V6 & GM 4 Cylinder 1.255" ID w/ 3/16" Keyway	4793
	Big Block – 1.610" ID w/ 3/16" Keyway	4797
GM LS	Gen III/IV LS-Type	4914
Chrysler	All V8 (Also Fits Some Blowers) – 1.542" ID w/ a 3/16" & (2) 1/4" Keyways 180° Apart	4799
	Hemi 5.7/6.1L	4944-CS
Ford, Buick, Pontiac	All V8 – 1.385" ID w/ 3/16" & 1/4" Keyways (Will Not Fit Buick 455)	4798

SPORTSMAN DEGREE WHEELS

- Multiple sized degree wheels provide precision & accuracy
- Size allows for use on the engine stand or with the engine still in the vehicle
- Can be bolted onto most harmonic balancers or used with a COMP® crankshaft socket
- Easy to read and clean



#4787

DESCRIPTION	PART #
7.5" Sportsman Degree Wheel	4787
9" Sportsman Degree Wheel	4790
Replacement Pointer	4794

PROFESSIONAL DEGREE WHEEL

This giant 16" diameter Pro Degree Wheel is machined from a 1/4" thick aluminum plate, red anodized and precision engraved. The open design allows degree bushing changes while the wheel is still on the engine. This extreme precision tool is found in most NASCAR shops and is a must for any professional racer or engine builder.

- 1" Center hole allows wheel to work with COMP Cams® crankshaft sockets

DESCRIPTION	PART #
16" Pro Degree Wheel	4791

PRO CAMSHAFT DEGREE KITS

(Cylinder Heads Off Engine)

This kit contains everything needed for camshaft degreing when the cylinder heads are OFF of the engine, including the COMP Cams® 16" Pro Degree Wheel.

KITS INCLUDES THE FOLLOWING:

- 16" Pro Degree Wheel – #4791
- Heads Off Degreing Fixture – #4901
- 0-1" Travel Dial Indicator – #4909
- 5" Dial Indicator Extension – #4912
- Plate Style TDC Stop – #4933
- Wire Degree Wheel Pointer – #4794
- One Crankshaft Socket

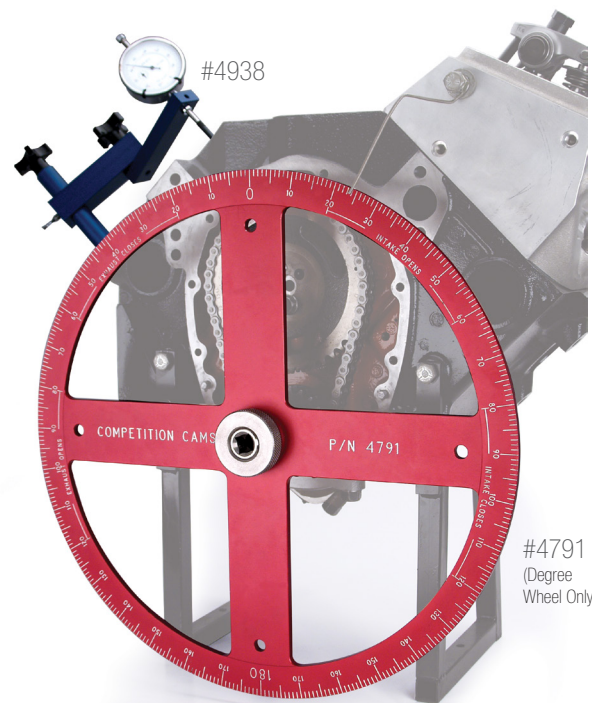

#4938

#4791
(Degree Wheel Only)

MAKE	DESCRIPTION	PART #
Chevrolet	Chevrolet Small Block, 90° V6 & GM 4 Cylinder Kit	4938
	Chevrolet Big Block Kit	4939
Chrysler	All Chrysler V8 Kit	4941
Ford, Buick, Pontiac	All Ford, Buick & Pontiac V8 Kit	4940



CAMSHAFT DEGREE KITS

(Cylinder Heads On Engine)

- Complete kit with necessary components to degree a cam
- Available for most popular engines
- Ships in a foam lined plastic carrying/storage case

KITS INCLUDES THE FOLLOWING:

- 9" Degree Wheel – #4790
- Cam Checking Fixture – #4902
- 0-1" Travel Dial Indicator – 4909
- Cam Degree DVD – #190DVD
- Wire Degree Wheel Pointer – #4794
- TDC Piston Stop – #4795
- (2) Lightweight Checking Springs – #4758
- Cam Degreeing Instruction Booklet – #145



#4796

DESCRIPTION	PART #
Universal Cam Degree Kit	4796
Ford 5.0L 4V Coyote Cam Degree Kit	4943

Note: We recommend the use of our crankshaft sockets with any degree kit.

CAMSHAFT DEGREE KITS

(Cylinder Heads Off Engine)

This kit contains everything needed for camshaft degreeing when the cylinder heads are OFF of the engine.

KITS INCLUDES THE FOLLOWING:

- 9" Degree Wheel – #4790
- Heads Off Degreeing Fixture – #4901
- 0-1" Travel Dial Indicator – #4909
- 5" Dial Indicator Extension – #4912
- Plate Style TDC Stop – #4933
- Wire Degree Wheel Pointer – #4794
- One Crankshaft Socket



#4934

MAKE	DESCRIPTION	PART #
Chevrolet	Small Block, 90° V6 & GM 4 Cylinder Kit	4934
	Big Block Kit	4935
GM LS	Gen III/VI LS-Type Kit	4942
Chrysler	All V8 Kit	4937
	Hemi 5.7/6.1L Kit	4944¹
Ford, Buick, Pontiac	All V8 Kit	4936

¹ Also works with cylinder heads ON engine

CHECKING SPRINGS

- Low tension checking springs can be installed by hand in place of valve springs
- Simplify measuring piston-to-valve clearance, rocker ratio, cam degreeing, etc.
- Set of two springs is enough for one cylinder



#4758

DESCRIPTION	FREE LENGTH	I.D.	O.D.	PART #
Low Tension Checking Springs – Pair	3.000"	.725"	.850"	4758-2

TWO-IN-ONE PROFESSIONAL CRANKSHAFT NUT ASSEMBLIES

- Two-piece assembly allows you to turn engine in either direction using a large diameter socket
- Heavy-duty, heat-treated and convenient
- Secure method of attachment for harmonic dampers, etc.
- Available in three applications

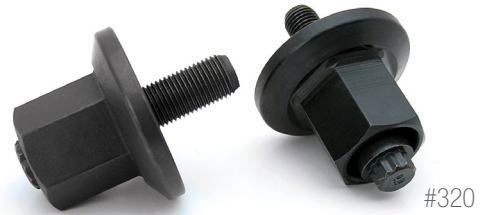

DESCRIPTION	PART #
Chevrolet Small Block	320
Chevrolet Big Block	322
Ford	324

TOP DEAD CENTER STOPS

- Positively stop piston in order to find Top Dead Center (TDC)
- Bolt-style screws into spark plug hole while plate-type bolts across any cylinder bore when heads are off
- Now fits GM Gen III/IV LS engines



DESCRIPTION	PART #
Deck Plate-Style – Heads Off (Universal)	4933
14mm Bolt-Style – Heads On (Most Engines)	4795
18mm Bolt-Style – Heads On (Big Block Ford)	4792

CAMSHAFT LOBE CENTER MARKING TOOL SET

With this tool the user marks the cam lobe with a type of marking fluid (e.g. dry erase marker or dychem), installs the cam, and then places the tool in the lifter bore. Next, the cam will be turned over to mark a line around the cam lobe. The cam is then removed, the distance from the edge of the lobe is measured and finally, shims are changed to achieve the correct lobe to lifter alignment.

- Three sizes for most common lifter bore diameters – .842", .875" and .904"
- Aluminum construction
- Has 1/4"-20 thread for bolt in the top



DESCRIPTION	PART #
Camshaft Lobe Center Marking Tool Set	5022

CAM CHECKING TOOLS

This innovative tool actually slides down into the lifter bore and rides on top of the camshaft in order to measure lobe lift and base circle runout. Each tool includes two followers: one for flat tappet cams and one for rollers. Two models are available, and each is double ended.

- Built-in o-ring holds tool firmly in the lifter bore while 1" travel dial indicator (not included) reads cam lift to .001"
- Two models available – one for GM (.842" dia.) and Ford (.875" dia.) and another for Chrysler (.904" dia.) and Top Fuel (1.0" dia.) lifter bores



DESCRIPTION	PART #
GM & Ford Cam Checking Tool	4925
Chrysler & Top Fuel Cam Checking Tool	4926
Extension – for Hemi Design Blocks & 440	4927
Optional 0-1" Travel Dial Indicator	4909

Note: Dial indicator sold separately.

CAM CHECKING FIXTURE

(Cylinder Heads On Engine)

This tool screws into any 1/4"-20 or 6mm valve cover bolt hole and with the use of a dial indicator (not included), allows you to measure cam lift at the rocker arm, pushrod or lifter. This multi-functional tool can also be used to check rocker ratio, piston-to-valve clearance and even crankshaft end play.

DESCRIPTION	PART #
Cam Checking Fixture – w/ Cylinder Heads On Engine	4902
Optional 0-1" Travel Dial Indicator	4909

Note: Dial indicator sold separately.



CAM CHECKING FIXTURE

(Cylinder Heads Off Engine)

This fixture was designed to maintain proper geometry while holding a dial indicator (not included) and 5" extension (included) precisely over the lifters. This professional quality tool is much easier to use and more precise than using a magnetic indicator base when degreasing a cam.

DESCRIPTION	PART #
Cam Checking Fixture for 1/2" and 7/16" Threads	4901
Cam Checking Fixture for 1/2" Head Studs	4915
Optional 0-1" Travel Dial Indicator	4909

Note: Dial indicator sold separately.

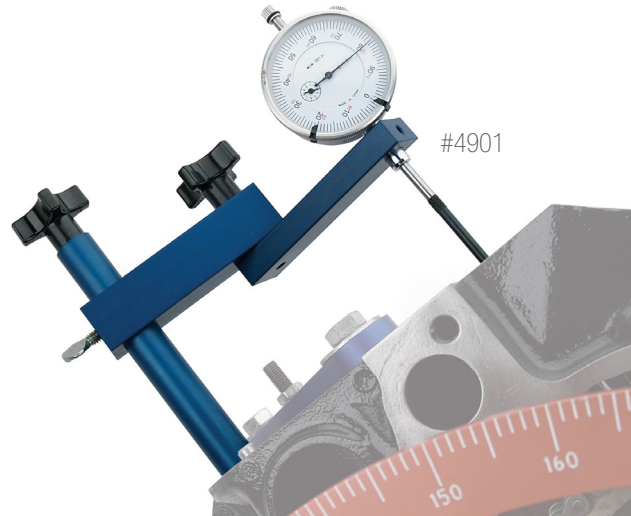

LIFTER BORE GROOVING TOOL

Developed by one of the top NASCAR engine builders, this innovative tool precisely grooves the lifter bore to ensure that pressure fed oil is directly injected into the contact area between the lifter and camshaft. This increased oiling significantly reduces wear on the camshaft and lifters and decreases the risk of premature failure during break-in. This machining operation to the block is quick, easy and inexpensive and serves as the best insurance for a new camshaft.

- Complete with grooving tool, cutter and handle
- Carbide cutter available separately
- Engine must be disassembled to use this tool – cuts groove from .009" to .012"

DESCRIPTION	PART #
.842" Dia. Grooving Tool (Std. Chevrolet Dia.)	5003
.874" Dia. Grooving Tool (Std. Ford Dia.)	5005
.904" Dia. Grooving Tool (Std. Chrysler Dia.)	5007
Kit Including .842", .874" & .904" Dia. Tools	5010
Kit Including .842" & .874" Dia. Tools	5011

REPLACEMENT PARTS

Carbide Insert for Grooving Tool	5004I
Replacement Bolt for Grooving Tool	5004BOLT

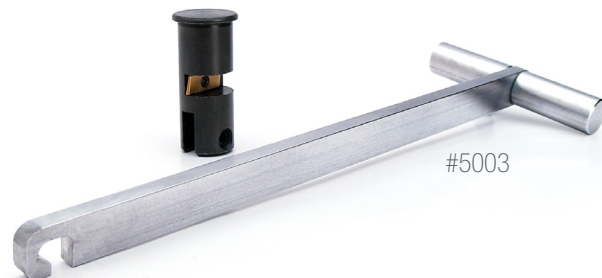

LIFTER BUSHING INSTALLATION TOOL

Until now, a block needed to be removed from the machine to have lifter bore bushings installed. But with the COMP Cams® Lifter Bushing Installation Tool, it's an easy job that doesn't require extra work. Common size mandrels ship with the tool and are constructed from heat-treated steel, then black oxidized and laser etched with the size. A drag option mandrel is available separately.

- Installs both keyed and non-keyed lifter bore bushings
- Perfect alignment every time
- Kit includes all the most common size mandrels – .842", .874", .904" and .937"

DESCRIPTION	PART #
Lifter Bushing Installation Tool	5335
Mandrel Set for 1.062" Keyed Lifter	5336



CAMSHAFT INSTALLATION HANDLES

These simple, yet effective handles provide good leverage and a non-slip grip when installing or removing a cam. These tools save time, pinched fingers and nicked cam bearings. COMP Cams® carries two styles – one for Chevrolet specific engines and a universal kit.

- Universal handle includes five interchangeable adapters that fit most domestic V6 and V8 engines, including Chevrolet, Ford and Chrysler
- Chevrolet specific handle includes necessary hardware that stores inside hex-design handle
- Chevrolet specific handle fits Small and Big Blocks

DESCRIPTION	PART #
Universal Camshaft Installation Handle	5311
Chevrolet Camshaft Installation Handle w/ Hardware	4919



PUSHROD ASSEMBLY TOOL

This simple tool makes assembling pushrod kits so easy that anyone can do it. Simply cut the tubing in a lathe, deburr the ends and use the assembly tool to press the ends in place, without the risk of splitting or bending the pushrod. Anyone who has ever used the block of wood and hammer technique will truly appreciate this innovative tool.

DESCRIPTION	PART #
Pushrod Assembly Tool	4913



PRO VALVE LOCK REMOVAL & INSTALLATION TOOLS

Don't risk your fingers when removing or installing valve locks. Our magnetic tool is definitely the best way to perform this delicate task. Several styles are available to cover most automotive and motorcycle applications.

TO INSTALL LOCKS: Compress valve spring, place valve locks on magnetic stem, push body of tool over the locks and position them on the valve stem, release valve spring.

TO REMOVE LOCKS: Use the magnetic stem to pluck off the valve locks once the spring is compressed.

DESCRIPTION	PART #
Pro Valve Lock Tool – 5mm, 5.5mm & 6mm Locks	5307
Pro Valve Lock Tool – 7mm, 8mm & 5/16" Locks	5308
Pro Valve Lock Tool – 11/32" Locks	5309
Pro Valve Lock Tool – 3/8" Locks	5310



#5307

SEAL SETTERS

If you're tired of sacrificing your time, your tools and your knuckles by trying to install PTFE seals on valve stems, then you need these COMP Cams® Seal Setters. This is a two-part tool comprised of bullet-nose sleeve (.100" wall) and hand piece.

DESCRIPTION	PART #
11/32" Seal Setter	5630
3/8" Seal Setter	5631
5/16" Seal Setter	5632
8mm Seal Setter	5633



#5630

VALVE SEAL INSTALLATION TOOL

- CNC-machined aluminum valve sealer makes installing PTFE seals on valve stems easy
- Works with .500" and .530" PTFE seals
- Prevents seal distortion or gouging during installation
- Anodized for durability

DESCRIPTION	PART #
Valve Seal Installation Tool	5334



#5334

ROCKER STUD PULLER & TAP GUIDE

- Provides convenient method to remove pressed-in rocker studs
- Simply slide tool over two side-by-side studs and crank down on retaining nut to force out the stud
- Use the tool with the supplied arbor to ensure proper alignment when tapping the stud boss for screw-in studs

DESCRIPTION	PART #
Rocker Stud Puller & Tap Guide	5306

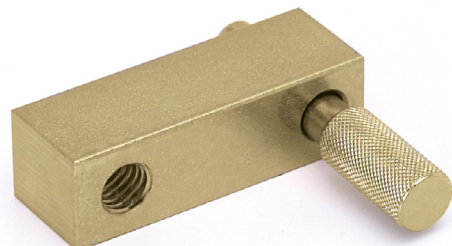

#5306

ENGINE OIL PUMP PRIMERS

- Allow the oil pump to be primed and the engine prelubed prior to initial start-up
- Eliminates the chance of a “dry start” and thus avoids premature engine damage
- Primers drop in place of distributor and, with the use of a drill, spin the oil pump to supply oil to critical engine components
- Both models feature a top alignment collar and Chevrolet model includes a bushing to pressurize the upper valve train

DESCRIPTION	PART #
Chevrolet V8 Oil Pump Primer	4921
Ford 260-351W 1/4" Oil Pump Primer	4922



#4921

VALVE TRAIN ORGANIZER TRAYS

These COMP Cams® Valve Train Organizer Trays are perfect for novice or pro engine builders alike. These durable polymer trays neatly store your valve train components while assembling or rebuilding your engine. Organizers are labeled on the front and rear to help keep track of your part location for reassembly. Each tray has built-in handles to make easy work of moving parts around your shop or garage.

DESCRIPTION	PART #
Valve Spring Organizer Tray	5327
Rocker Arm Organizer Tray	5329



#5329

#5327

LIFTER CASE

- Constructed of chemically resistant, cleanable polymer
- 8 9/16" long, 2 7/16" wide and 2 1/4" tall

DESCRIPTION	PART #
Lifter Case	5305



#5305

ADJUSTABLE VALVE SPRING REMOVERS

- Engineered from billet aluminum with heavy-duty construction to handle even the heaviest spring pressures
- Fully adjustable for different valve angles
- Screw mechanism maintains position to easily remove/install valve locks
- Retainer housing reducer for use on COMP® spring changers, particularly for use on our adjustable valve spring removers on smaller diameter springs (eg. Beehive™ or Ford Modular Springs)

DESCRIPTION	PART #
Adjustable Valve Spring Remover – SBC LS1/LS6	5642
Adjustable Valve Spring Remover – SBC w/ Jesel/T&D Rockers	5640
Adjustable Valve Spring Remover – BBC w/ Jesel/T&D Rockers	5643 ¹
Adjustable Valve Spring Remover – Stud Mount/All 7/16" Studs	5645
Spring Remover Kit for Big Chief Heads	5644
Retainer Housing Reducer	5641

¹ Also works in SBC w/ splayed valve heads, SB2 w/ Jesel/T&D rockers and SBF w/ Jesel/T&D rockers

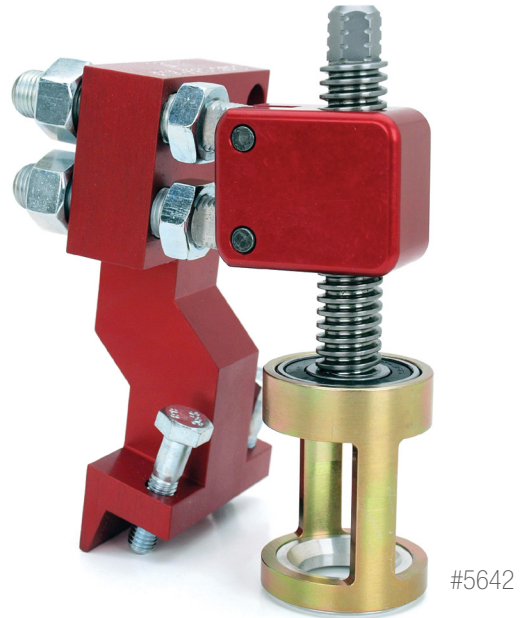

#5642

VALVE SPRING COMPRESSORS

Built from an exclusive design valve spring removal tools are engineered specifically to work with all GM Gen III/IV LS-type or Small Block Chevy and Small Block Ford engines. The easy-to-use custom design enables the removal of one or two valve springs at a time without the hassle of removing the rocker stand or any of the other installed rockers. The tool works both with cylinder heads installed on an engine in a vehicle or with the cylinder heads off. The simple design facilitates easy usage in vehicles where other tools are incapable of reaching the tight spaces.

DESCRIPTION	PART #
GM LS Valve Spring Compressor	5462
Small Block Chevrolet/Small Block Ford Valve Spring Compressor	5337



#5462

HEAVY-DUTY MANUAL VALVE SPRING COMPRESSOR

Our super-duty compressor is constructed of a welded steel box-tubing frame and an over-center type clamping device that can compress any valve spring. The compressor arm slides up and down for adjustment and utilizes a locking pin for speed and ease of use. A base is offered to hold the unit upright in order to use the compressor in conjunction with a mini spring tester.

DESCRIPTION	PART #
Heavy-Duty Manual Valve Spring Compressor	5333



#5333

VALVE SPRING COMPRESSOR

The proprietary wave beam design of this 2000 Valve Spring Compressor provides ultra rigidity in a lightweight package. This heads off spring compressor features a dual adjustable design that allows for perfect positioning and easy access to valves and springs. The spring cage has a small 1" inside diameter flange that works perfectly with most popular valve springs.

DESCRIPTION	PART #
2000 Valve Spring Compressor	5601

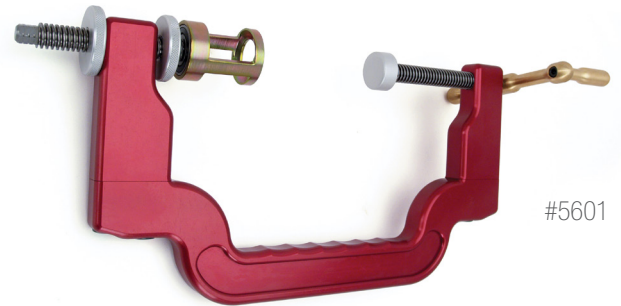

#5601

DELUXE UNIVERSAL OVERHEAD SPRING COMPRESSOR

The Deluxe Universal Overhead Valve Spring Compressor easily removes valve springs on most cars and light trucks. This versatile spring compressor can be used with the cylinder heads on or off the engine. The unique tool features a removable handle that allows for use with a 5/8" socket or wrench in confined areas and an extra-long leg for other applications. For best results, use with our 14/18mm Air Operated Valve Holder (#5657) to pressurize the cylinder and keep the valves in place during removal of the springs and keepers.

DESCRIPTION	PART #
Deluxe Universal Overhead Spring Compressor	5606



#5606

SHAFT MOUNT VALVE SPRING COMPRESSORS

If you've ever tried to remove high pressure valve springs with shaft mounted rocker arms while the cylinder heads are still on the engine, you know what a chore it can be. The COMP® Shaft Mount Valve Spring Compressors are designed to facilitate valve spring removal on heads with shaft mounted rockers.

- Bolt tool shaft in place of rocker shaft, place tool feet over retainer, slide on handle and pull down to compress spring
- Once valve locks are removed, flip tool out of the way and remove spring
- Simple reassembly

MAKE	DESCRIPTION	PART #
Chevrolet	Small Block & 90° V6 Tool	5321
	Big Block Tool	5322
	Dart Big Chief Pivot Shaft (Use w/ BBC Tool)	5325
Chrysler	V8 318-360, W2 & 3.3 V6 Tool	5323
	V8 383-440 & B1 Tools	5324



#5321

VALVE SPRING HEIGHT MICROMETERS

- Quickest, easiest, most accurate way to measure valve spring installed height
- Install just like a valve spring, then tool is expanded until it fully seats valve, locks and retainer
- Simulated installation allows ultra precise readings
- Tool is read like a micrometer and is accurate to .001"

DESCRIPTION	PART #
.600"-.950" Range Height Micrometer (for Small Diameter Beehive™ Springs)	4950
1.400"-1.800" Range Height Micrometer	4928
1.600"-2.200" Range Height Micrometer	4929
1.600"-2.200" Range Height Micrometer (for Beehive™ Springs)	4930



ADJUSTABLE ON HEAD VALVE SPRING TESTER

A great way to check spring pressure on an assembled engine, this billet aluminum tool fits onto your rocker arm for quick pressure checks.

- Adjustable to use with almost any rocker length
- Measures pressures up to 600 lbs.

DESCRIPTION	PART #
Adjustable On Head Valve Spring Tester	5639



MINI VALVE SPRING TESTER

- Designed to be a portable and low cost alternative to bench top style spring testing
- 0-1000 lb. tester scaled in 20 lb. increments
- Can be placed in a vise, used with an arbor press or used in a drill press (w/ flange)

DESCRIPTION	PART #
1-1000 lbs. Mini Valve Spring Tester	5314
Drill Press Flange	5315
Calibrated Test Spring	5316



PROFESSIONAL TWO-IN-ONE HARMONIC BALANCER PULLER/ INSTALLATION TOOL

- Features a hardened threaded shaft with an alloy nut combined with a roller thrust bearing puller plate
- Includes various size puller bolts for most uses
- Kit fits GM, Ford and Chrysler crankshafts
- Black oxide finished with storage box

DESCRIPTION	PART #
Two-In-One Harmonic Balancer Puller/Installation Tool	300



UNIVERSAL HARMONIC BALANCER INSTALLATION TOOL

- Kit fits all domestic and most foreign engine applications
- Utilizes thrust bearing to gently ease the harmonic balancer onto the crank snout
- Eight interchangeable adapters include: 7/16", 1/2", 9/16", 5/8", 3/4", 12mm, 14mm and 16mm

DESCRIPTION	PART #
Universal Harmonic Balancer Installation Kit	4920
Thrust Bearing	5670
7/16"-20 Adapter	5674

Note: Other replacement parts available, call for part numbers or visit www.compcams.com.



CRANK GEAR INSTALLATION TOOL

The only way to ensure proper installation of the lower timing gear without fear of damage is to press it on with equal distribution of force over the entire surface of the gear. By using the COMP Cams® Crank Gear Installation Tool used in conjunction with the COMP® Part #4920 Harmonic Balancer Installer, equal and constant pressure is applied, and the chance of gear damage is minimized.

DESCRIPTION	PART #
Crank Gear Installation Tool	4789

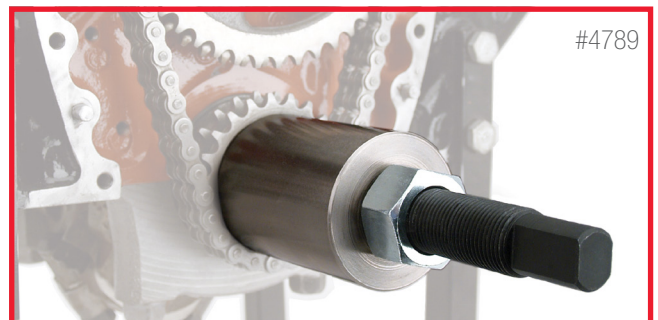

CONNECTING ROD BALANCER

This innovative fixture was designed to match-weight a set of Small Block Chevrolet large journal connecting rods without the use of a scale. What this tool actually does is compare two rods at a time to show which one is heavier.

- Allows material to be removed from heavier rods until weight is balanced
- Fixture will hold rods from either the big or small end so both rotating and reciprocating weights can be balanced

DESCRIPTION	PART #
Connecting Rod Balancer	4999



PRO HEAD CC KIT

Our kits provide everything you need to properly cc cylinder head combustion chambers, intake and exhaust runners, intake manifolds or cylinders. All kits contain a precision glass buret with integral petcock, a stand & clamp assembly, a flat plexiglass plate to cover the combustion chamber and instructions on how to properly cc cylinder heads.

Note: Burets and kits must be shipped by air service

- Precision glass burets are compatible with alcohol, parts washer fluid or virtually any liquid you may need to measure
- Scales are marked off in .2cc increments and reads the amount poured, eliminating any math involved

DESCRIPTION	PART #
100cc x .2cc Pro Head CC Kit	4974
250cc x 1cc Pro Head CC Kit	4970
Replacement 100cc x .2cc Glass Buret	4991
Replacement Stand & Clamp Assembly	4992
Replacement Plexiglass Sealing Plate	4993

Note: Cylinder head and holders not included.



ECONOMY HEAD CC KIT

If you only occasionally need to cc cylinder heads, the Economy Head CC Kit is for you. It uses a 100cc graduated flask that measures in 1cc increments, so you can get accurate results without the expense of a buret. This kit also includes a combustion chamber sealing plate and instructions on how to cc cylinder heads.

DESCRIPTION	PART #
100cc x 1cc Economy Head CC Kit	4975
Replacement 100cc x 1cc Graduated Flask	4994
Replacement Plexiglass Sealing Plate	4993

Note: Cylinder head and holders not included.

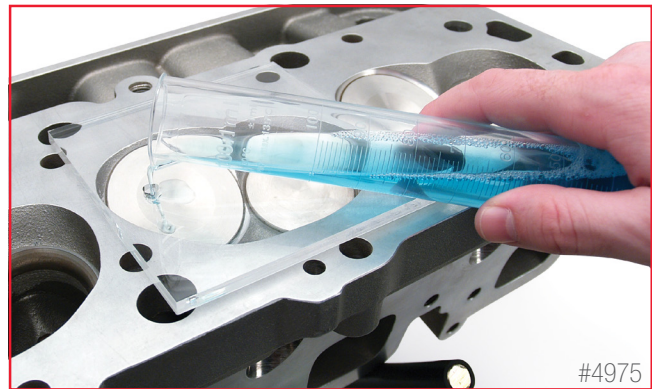

V-STYLE HEAD HOLDERS

- Perfect for whenever you perform any type of cylinder head modifications or maintenance
- Stands create the ability to put the heads in any position and rotate as necessary
- Handy for holding cams and crankshafts
- Two versions available – cast aluminum and welded steel

DESCRIPTION	PART #
V-Style Aluminum Head Holders (Pair)	5331
V-Style Steel Head Holders (Pair)	5332

Note: Cylinder head not included.



VALVE LASH ADJUSTMENT TORQUE WRENCH

The Valve Lash Adjustment Torque Wrench is a combination precision torque wrench and valve adjustment tool. This exceptional tool simplifies making precise valve lash settings by properly torquing adjuster nuts every time.

- One tool works for all "shaft" style rocker arms
- Accepts any standard 3/8" drive socket (not included)
- Comes with 1/8", 5/32" and 3/16" hex keys



#5600

DESCRIPTION	PART #
Valve Lash Adjustment Torque Wrench	5600

EZ VALVE LASH WRENCHES

You no longer need three hands to adjust valves – you just need the right tool. COMP Cams® EZ Valve Lash Wrenches make valve adjustment easier and quicker than ever.

- Constructed of 17-4 stainless steel
- Heat-treated and electropolished to satin finish
- Offer sizes for most popular polylock & set screw combinations



#5300

DESCRIPTION	PART #
7/16" Wrench w/ 1/8" T-Handle – Fits Jesel Rockers	5302
1/2" Wrench w/ 3/16" T-Handle – Fits T&D and COMP® Rockers	5304
9/16" Wrench w 3/16" & 7/32" T-Handles	5300
5/8" Wrench w/ 3/16" & 7/32" T-Handles – Fits COMP® Stud Mount Rockers	5301
7/16" Wrench w/ 5/32" T-Handle	5638
7/16" Wrench w 3/16" T-Handle – Chrysler Hemi	5636
1/2" Wrench w/ 3/16" T-Handle – Chrysler Hemi	5637
9/16" Wrench w/ 1/8" T-Handle – Chrysler Hemi	5303

REPLACEMENT PARTS	
1/8" T-Handle	5658
5/32" T-Handle	5661
3/16" T-Handle	5659
7/32" T-Handle	5660



SCAN THE QR CODE
to watch a video on properly
setting valve lash.



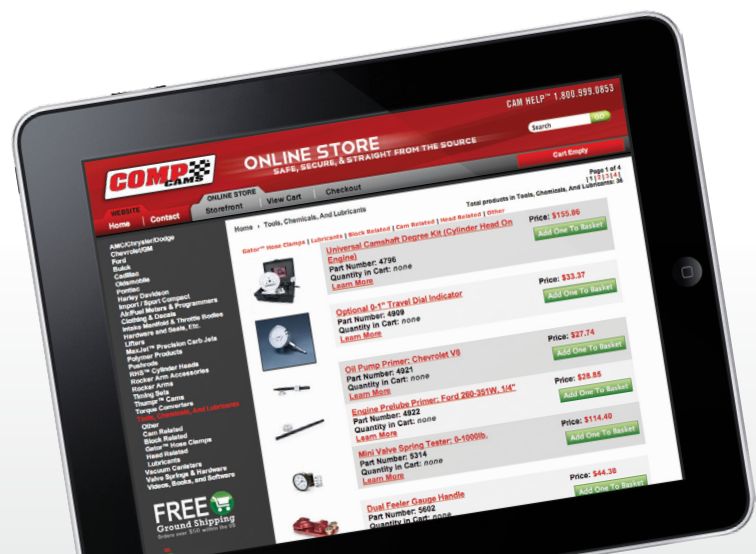

Scan the QR Code to see the full selection of COMP Cams® tools.

DUAL FEELER GAUGE HANDLE

This Dual Feeler Gauge Handle holds two sets of feeler gauges on the same handle and is ideal for intake and exhaust or go, no-go gauges. This gauge handle will accept various styles of 1/2" wide feeler gauges depending on your application.

DESCRIPTION	PART #
Dual Feeler Gauge Handle	5602

Note: Feeler gauges not included.



#5602

REMOTE STARTER SWITCH

How many times have you been working on an engine and needed someone to sit inside the car and bump the starter over, or worse yet, been showered with sparks when you used a screwdriver across the starter solenoid? With this push-button Remote Starter Switch you can turn the engine over from under the hood, all by yourself. Just think how handy this will be the next time you adjust your valves.

DESCRIPTION	PART #
Remote Starter Switch	5635



#5635

LOUIS TOOL

When switching factory Small Block Chevrolet heads over to 1.6 ratio rockers, the pushrod will rub on the bottom of the pushrod slot in the head. Long time cylinder head man Louis Cox designed this tool to simplify the modification needed in this situation. The tool allows use of hand drill and 5/16" drill bit to elongate the pushrod slot in the precise location and size necessary.

DESCRIPTION	PART #
Louis Tool	4710

Note: Tool is designed to wear so a new one should be purchased for each set of heads.

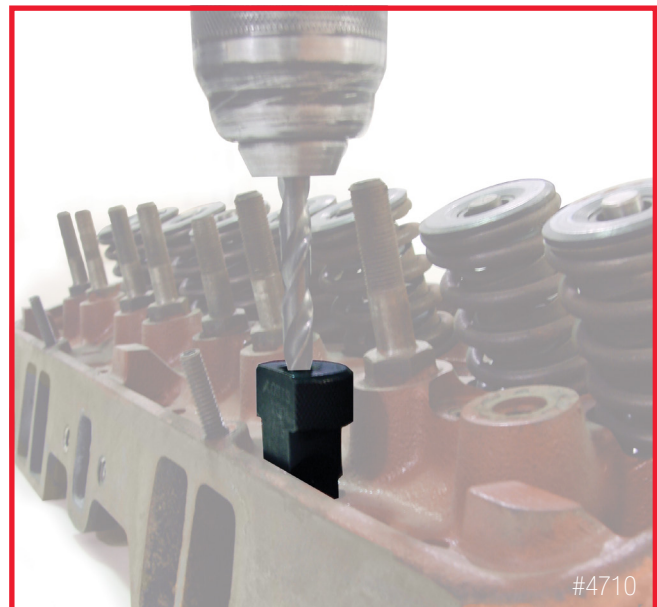

#4710

DIAL INDICATORS & EXTENSIONS

- 0-1" Travel by .001" jeweled dial indicator is compatible with all COMP® products that require the use of a dial indicator
- Feature include lug back, 3/8" shaft, 0-100 dial face and revolution counter
- Two length extensions available

DESCRIPTION	PART #
0-1" Travel Dial Indicator	4909
5" Tip Extension	4912
6" Tip Extension	4911



#4909

MAGNETIC DECK CHECKER

To calculate true compression ratio, it's necessary to measure the distance between the deck surface of the block and the piston deck. Our machined aluminum deck checker incorporates magnets to hold itself firmly to the block for simple and accurate measurements. Mount a dial indicator (not included) in the center for deck height, or mount one indicator in each end to check piston rock.

DESCRIPTION	PART #
Magnetic Deck Checker	4900
Optional 0-1" Travel Dial Indicator	4909

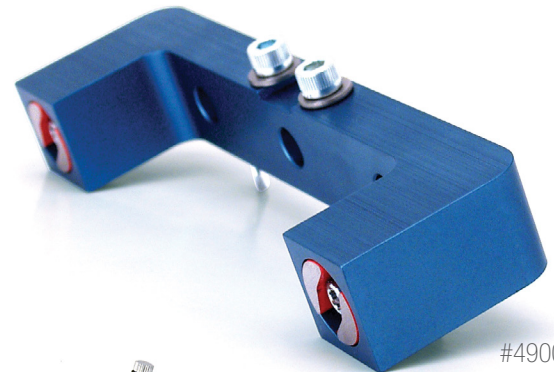

#4900

DIAL INDICATOR MAGNETIC BASE

Mount a dial indicator to this base or mount it to the extension rod for a longer reach.

DESCRIPTION	PART #
Compact Dial Indicator Magnetic Base	4907
Optional 0-1" Travel Dial Indicator	4909

Note: Dial indicator sold separately.



#4907

DIGITAL PROTRACTOR

The COMP Cams® Digital Protractor lets anyone measure angles with true digital accuracy. Check chassis setups, engine geometries or just level up that new piece of machinery. This is a tool you'll wonder how you ever did without and will find uses for everywhere.

DESCRIPTION	PART #
Digital Protractor	5603



#5603

TELESCOPING GAUGE SET

- Used to measure slots, grooves, recesses, cylinders, etc.
- Especially useful for measuring valve spring installed height
- Each set contains (6) gauges that cover a total range of 5/16" to 6", all enclosed in a storage pouch

DESCRIPTION	PART #
Telescoping Gauge Set – 5/16"-6" Range	5320

Note: Connecting rod not included.



#5320

DIAL BORE GAUGE COMBO

Our two most popular sets are available in one great combo. Only one tool is needed to measure rod bores, main bearings and cylinder bores – now at a cost that everyone can afford. And setting the bore gauge to zero with a master or micrometer allows you to see the difference in the bore that you are measuring so a precise measurement can be performed.

KITS INCLUDES THE FOLLOWING:

- Standard 2-6" bore gauge setup
- Special adapter and anvil/shim kit for the 1.4" – 2.4" set
- Supplied with a .0005" precision dial indicator

DESCRIPTION	PART #
Dial Bore Gauge Combo	5605



#5605

6" DIAL CALIPERS

Calipers are the handiest precision measuring tool available. The COMP Cams® 6" Dial Calipers can measure inside dimensions and outside dimensions or depth to .001" or .0005" accuracy over their entire 6" range.

- Rigid stainless steel body
- 0-100 Revolution dial
- Smooth thumb rollers
- Protective fitted case

DESCRIPTION	PART #
0-6" .001" Dial Calipers	4908
0-6" .0005" Digital Calipers	5634



#4908

ProRacing Sim® offers a complete line of affordable and accurate computer software simulations. These programs were carefully designed to be easy-to-navigate for beginning automotive enthusiasts, yet robust enough to help the professional engine builder or racer find a winning edge. All software products incorporate a custom user interface designed for popular Windows 98/Me/Vista/Win7/Win8 (32 & 64 bit) applications.

DESKTOP DYNO5™

Capable of testing any 1-12 cylinder, 4-cycle engine, this innovative software features a custom interface that includes easy-to-use Direct-Click™ menus that allow you to select from a wide variety of parts – or enter custom specs. DeskTop Dyno5™ also includes several calculators to aid you with detailed engine analysis, including a CamMath QuickCalculator™, Induction-Flow Calculator and an Air Flow Pressure-Drop Calculator.

- Detailed graphs display projected HP, torque, VE, engine pressures and more
- Quicklterator™ automated testing tool helps find optimum component combinations for virtually any engine application
- Includes combustion chamber modeling, improved accuracy and new component choices to put you within 5% of real dyno data
- Displays results at every 500 RPM ranging from 1,000 to 14,500 RPM

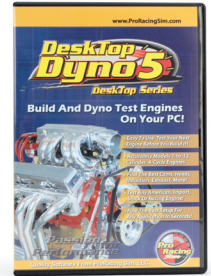

#186011

DESCRIPTION	PART #
DeskTop Dyno5™ Software	186011

DYNOSIM5™

Now you can dyno test your next engine project BEFORE you even build it. The DynoSim5™ software can accurately simulate any 4-cycle engine – including turbo, supercharged, nitrous and alternative fuel applications. Features include hundreds of new engines, advanced modeling, expanded results graphs and tables, comprehensive printouts, automatic updating over the web, and more. As a supplement to DynoSim5™, we now offer CamDisk8™ that will automatically install additional cam files to the cam library created when you installed DynoSim5™. With this additional disk, you will have access to over 6,000 camshafts that you can search, load and test in any simulated engine.

- Features combustion & ignition curve modeling, advanced rocker ratio mathematics, multiple graphs and data displays, & a higher degree of accuracy
- Also includes unique Pro Tools™ Kit that enhances functionality
- Incorporates new Quicklterator™ and ProLterator™ technologies that help find the best component combinations for optimal power

*CamDisk8™ requires previous installation of DynoSim5™ and is compatible with DynoSim5™ only. CamDisk8™ is sold separately from DynoSim5™.

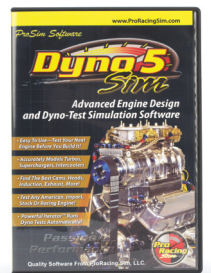

#181501

DESCRIPTION	PART #
DynoSim5™ Software	181501
CamDisk8	180908

DYNAMATION-5™ WAVE ACTION ENGINE SIMULATION

For the competitive engine builder, time is money. Thanks to the Dymation-5™ Wave Action Engine Simulation, you can reduce the cost and time of engine development, while maintaining your competitive edge. By letting you peer inside a running engine, this advanced engine simulation reveals live pressure waves and mass flow in cylinders and engine passages. While Dymation-5™ will accurately display how much power your engines makes, it will also show you where and how this power is achieved.

- 3D cutaway engine shows mass flow, port velocities and pressures – synchronized to the crank-angle data displayed in Dymation-5™
- Examines camshaft lift, duration, centerline and lobe separation angles
- Fully analyzes induction runner lengths, port taper angles, port areas, cylinder head flow variations and cam timing

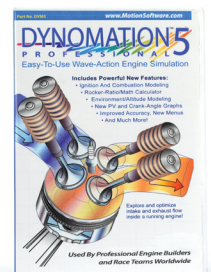

#181810

DESCRIPTION	PART #
Dymation-5™ Wave Action Engine Simulation Software	181810



DESKTOP DRAG5™

Rather than making trial runs at the track to determine the best setup up for your hot rod, motorcycle or dragster, why not save money and time by doing it all on your Windows-equipped PC? DeskTop Drag5™ is an inexpensive, yet highly-accurate 1/4- and 1/8-mile drag race simulation that allows you to analyze the winning potential of your vehicle by selecting various parts from built-in menus – or by entering your own custom specs. With this advanced software you can model virtually any vehicle’s design, weight, frontal area, aero drag, wheelbase, tires and even driving style.

- Features advanced graphics that display ET, mph, engine and clutch (trans input shaft) RPM, acceleration, aero drag, tire slip, etc.
- Unique “zoom-in” feature allows you to analyze starting line or top-end performance
- Design, build and drag test cars, motorcycles, dragsters – front- or rear-wheel drive
- Uses an advanced Windows interface with easy-to-use DirectClick™ Menus
- Pop-up TimeSlip™ provides a detailed performance overview



#186401

DESCRIPTION	PART #
DeskTop Drag5™ Software	186401

DRAGSIM5™

In the past, finding the optimal chassis, driveline, gear ratios and other characteristics for desired street or drag strip performance was an expensive process characterized by trial-and-error – but not anymore. With DragSim5™ you can assemble and test the performance of any vehicle imaginable on a 1/8 or 1/4-mile strip. A pop-up TimeSlip™ provides an easy-to-read visual summary of overall vehicle performance. Also included is the sophisticated Traction Calculator™ that optimizes tire/track modeling and improves overall simulation accuracy.

- Build and test any domestic or sport compact vehicle on your PC; accurately determines speeds for front or real-wheel drive vehicles
- Analyze engine RPM, clutch RPM, acceleration, tire slip, ET, aero drag and so much more
- ProTools™ Kit (optional) includes DataZones™, ProItrator™, ProData™ Display and ProPrinting™
- Determines the best components for street cars, motorcycles or dragsters
- Patented Traction Calculator™ improves simulation modeling and accuracy
- Pop-up TimeSlip™ gives an instant performance overview



#181601

DESCRIPTION	PART #
DragSim5™ Software	181601

CAMQUEST™ 6 CAM SELECTION SOFTWARE

With the CamQuest™ 6 Cam Selection Software from COMP Cams®, even novice engine builders can select proper camshaft and valve train combinations like professionals. Users only need to answer a few application specific questions about their engine/vehicle combinations. The program then provides the top matching COMP Cams® camshafts for your application, related valve train components, a complete camshaft spec card and even your engine’s projected horsepower and torque output.

- Recommends cams based on criteria selection, provides spec card and predicts power and torque output
- Compares different types of cams (hydraulic roller to flat tappet to solid roller) to see which is the best fit
- Picks cams for stock replacement to serious race applications and all points between (38 different usage classifications to choose from)
- Specifies all related valve train parts and probable output
- Works for carbureted, fuel injection, supercharged, turbo and nitrous applications
- Has a variety of popular head and manifold combinations to choose from, or the user can enter exact flow numbers
- It’s absolutely FREE

DESKTOP FASTLAP5™

Using the latest in performance simulation technology, DeskTop FastLap5™ analyzes the handling capability of any vehicle on any closed-course, asphalt track. This top-of-the-line software can perform a comprehensive turn-by-turn analysis of any vehicle provide you with the best chassis and vehicle setup. It can also run an extensive simulation and display lap times and full vehicle “telemetry” to within a small percentage of true track-test data. Once you choose your setup combination, DeskTop FastLap5™ will take your vehicle through a “hot lap” with instant results.

- Accurately design, build and simulate any vehicle on any closed-course asphalt track in just a few seconds
- Tests weight, wheelbase, center of gravity, aerodynamics, shifting and braking points, tires, gear ratios, suspension and power curves
- Features include DirectClick™ menus, QuickAccess™ buttons, precision data display with reticule, 160-page color users’ manual and more
- Choose from over 40 built-in tracks or model your own with help from the fully-graphic Track Editor™ application
- Custom user interface displays vehicle specs and track-testing results

DESCRIPTION	PART #
DeskTop FastLap5™ Software	186301

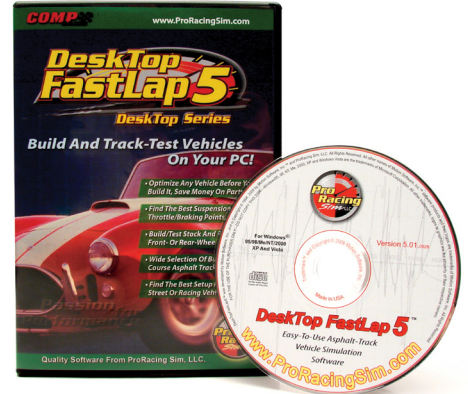

#186301

FASTLAPSIM5™

Building a well-suited vehicle for road racing competition is a never-ending search for the perfect combination of suspension design, tires, gear ratios, braking points, steering path and a hundred other variables. Thanks to FastLapSim5™, you can accurately simulate the complex interaction of forces, speeds, and accelerations generated by stock, high-performance, or all-out race vehicles. This advanced software also features the Pro Tools™ Kit, which includes such enhanced features as DataZones™, real time data display, spring/damper calculator, ProData™ Display and ProPrinting™.

- Advanced road racing software accurately determines best possible elapsed time for road course, ovals or autocrosses
- Pick from 40+ of the world’s most well-known tracks or design any closed course using the innovative, built-in TrackEditor™
- Determines optimum driving path, shifting and braking points, aerodynamics, throttle positions, gear ratios and much more
- Software includes cutting-edge Pro Tools™ Kit that extends the functionality of many program features
- Easy-to-use interface allows comparison between as many as four vehicles at once – anything from road racers to street racers to NASCAR

DESCRIPTION	PART #
FastLapSim5™ Software	181701



#181701

CAMQUEST™

CAMSHAFT SELECTION SOFTWARE

HOW TO GET YOUR FREE COPY

1. GO TO WWW.CAMQUEST.COM.
2. FILL OUT THE ONLINE REGISTRATION FORM.
3. You will then be able to input your information and begin receiving recommendations for absolutely **FREE** in a live, web-based interface.





THE PROPER PROCEDURE TO INSTALL AND DEGREE A CAMSHAFT DVD

This DVD takes you through the various stages of camshaft installation and the degreing process, completely explaining each step. Whether you're a first time builder or a professional, you'll refer back to this DVD again and again.

DESCRIPTION	PART #
The Proper Procedure to Install and Degree A Camshaft DVD	190DVD



#190DVD

DOOR SLAMMERS: THE CHASSIS BOOK

This is the bible for door slammer tuning and building. If you own or are building a drag race car with doors, you need this book. It contains a wealth of knowledge not available from any other source. Hundreds of photographs and drawings help explain many of the technical aspects of tuning and operating your race car.

DESCRIPTION	PART #
Door Slammers: The Chassis Book	158

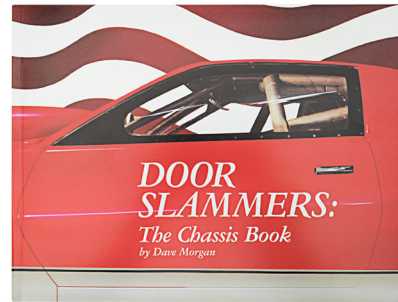

#158

DECALS

DESCRIPTION	PART #
6" Decal	113
12" Contingency Decal	110
24" Decal	257
12" Spring Decal	105
12" Rocker Decal	111
12" Lifter Decal	115
12" Belt Drive Decal	149
Shop Door Decal	197
3 Decal Card	COMP3-101
Multi Logo Decal Card	COMP3-103



BANNER

DESCRIPTION	PART #
3' x 8' Banner	308



#308

FENDER COVER

Made of heavy-duty padded vinyl, this fender cover has a non-skid backing to protect your car's finish. It resists acid and grease and is easily washable with mild solvents or detergents. Black with full color COMP Cams® logo.

DESCRIPTION	PART #
Fender Cover	C603



#C603



HATS

Stylish twill or mesh baseball-style hats and the COMP Cams® Beanie feature full color embroidered logos on the front and “compcams.com” on the adjustable back strap. These low profile hats are both comfortable and great looking.

The newest addition to the COMP® hat line is the “Since ‘76” fitted hat. Designed in the popular flexfit style, this hat is one size fits most and features a white front with a silver and black COMP Cams® logo in the lower left and a black brim with white stitching. The back is constructed of breathable mesh, with “compcams.com” embroidered in white. Meanwhile, the right side of the hat includes the phrase “Winning Horsepower Since 76.”

DESCRIPTION	PART #
Camo Hat	C638
Black Hat	C639
Gray & Black Trucker Style Hat	C663

DESCRIPTION	PART #
Black & White Retro Logo Hat	C1021
"Since '76" Fitted Hat	C642
Beanie	C641

LOGO T-SHIRTS

The perfect choice for any race or street event or even for working in your shop, these t-shirts are our most popular sellers. The “Motorsports” t-shirt features a full COMP Cams® Motorsports design on the front with a small logo on the upper back neck while the black shirt features a small COMP® logo on the left chest and full logo on the back. New to the lineup of t-shirts is the “Absolute Leader” t-shirt featuring a COMP® logo on the back surrounded by words that define who COMP Cams® is.

DESCRIPTION	PART #
Motorsports T-Shirt (Small-5X)	C1033
Logo T-Shirt (Small-3X)	C1020
Absolute Leader T-Shirt (Small-5X)	C1036

* When ordering, add "-size" to the end of the part number



RETRO LOGO T-SHIRT

The COMP Cams® Retro Logo T-Shirt features the message “Horsepower Never Goes Out of Style.” With full color, pinup graphics on the back and the COMP Cams® retro logo on the front left chest area, this high-quality, Gildan Ultra Cotton T-Shirt is pre-shrunk and will keep its shape for years to come. Available in sizes from Small to XXXL.

DESCRIPTION	PART #
Black Retro Logo T-Shirt	C1025

* When ordering, add "-size" to the end of the part number



WINGS T-SHIRT

Want to stand out from the crowd? Try the COMP Cams® Wings T-Shirt, which features cool, custom wings graphics and COMP Cams® labeling on the front and back. The charcoal gray Gildan Ultra Cotton tee is pre-shrunk and available in sizes Small through XXXL. It displays a trendy, retro look that celebrates COMP Cams® more than three decades of successful valve train component development and race winning ways.



#C1023

DESCRIPTION	PART #
Wings T-Shirt	C1023

* When ordering, add "-size" to the end of the part number

THUMPR™ ROD T-SHIRTS

Thumpr™ Cams have become one of the most popular selling camshaft series of the COMP Cams® line, so make sure to buy a Thumpr™ t-shirt to match. With a full color design on the back and the Thumpr™ logo on the front, these tan and charcoal t-shirts are a perfect wear for that cruise-in to show off your nasty sounding, Thumpr™-equipped ride. Available in sizes S-XXXL.



#C1011

#C1012

DESCRIPTION	PART #
Thumpr™ Rod Tan T-Shirt	C1011
Thumpr™ Rod Charcoal T-Shirt	C1012

* When ordering, add "-size" to the end of the part number

LONG SLEEVE T-SHIRT

With subtle, two tone gray graphics, this shirt features a unique COMP Cams® logo design with pinstriping on the front and a graphic featuring Chevy, Ford and Mopar cams on the back. This black, Gildan Ultra Cotton t-shirt won't shrink and is perfect for everyday wear, to work in the shop or at the track. Buy yours today! Available in sizes S-XXXL.



#C1032

DESCRIPTION	PART #
Long Sleeve T-Shirt	C1032

* When ordering, add "-size" to the end of the part number

DRI MESH POLOS

These dri mesh polos provide the driest moisture wicking protection available to keep you cool, regardless of the weather. These shirts are made from 100% double poly mesh that stands up to repeated washings without fading and require no ironing. They look great straight out of the suitcase – an important feature for traveling racers and performance enthusiasts. Available in sizes Small - XXL.

DESCRIPTION	PART #
Black Polo	C1015
Gray Polo	C1016

* When ordering, add "-size" to the end of the part number



#C1015

#C1016

KIDS' T-SHIRTS

COMP Cams® now offers three different youth tees for all ages. For infants and toddlers, there is the onesie available in 6 month, 12 month and 18 month sizes. For older children, we offer the youth blue tee that is available in sizes XS (2-4), S (6-8) and M (10-12). And last, for preteens, we offer the youth Wings t-shirt that is identical to our adult Wings tee. Available in sizes L (14-16) and XL (18-20). Each shirt features screen printed logos and graphics.

DESCRIPTION	PART #
Onesie	C1034
Youth Blue T-Shirt	C1028
Youth Wings T-Shirt	C1029

* When ordering, add "-size" to the end of the part number



#C1029

#C1028

#C1034

OUTERWEAR

COMP® sweatshirts are made of a 50/50 cotton/poly blend and are available in sizes M-XXXL. The crewneck sweatshirt features an embroidered COMP Cams® logo on the left chest while the hooded sweatshirt has a unique, two tone gray COMP® logo in the center chest.

Our high-quality jacket is made from a durable Teklon nylon outer shell and backed by a lightweight fleece inner lining. Available in sizes Small through XXXL, the COMP Cams® Race Track Jacket features an embroidered COMP Cams® logo on the front left chest. The adjustable cuffs and elastic waist provide hours of comfortable use and the interior pockets are handy to carry personal items.

DESCRIPTION	PART #
Crewneck Sweatshirt	C1017
Hooded Sweatshirt	C1018
Nylon Race Jacket	C1022

* When ordering, add "-size" to the end of the part number



#C1022

#C1017

#C1018

APRON

This handy three pocket apron is rugged and durable and is perfect for working on your race or street vehicle. Available in black with the COMP Cams® logo on the middle chest, these are one size fits all. Available separately is our logo patch.

DESCRIPTION	PART #
Three Pocket Apron	C604
Logo Patch	C801



#C604

COMPETITION CAMS, INC.

General Policies

Technical and sales personnel are available from 7:00 a.m. to 8:00 p.m. CT, Monday through Friday and Saturday 9 a.m. to 4 p.m. CT. COMP Cams® is closed on Sundays and legal holidays.

Prior to contacting us for technical assistance, it is helpful to obtain a copy of the cam recommendation form from our website. The information requested in this form will help us to recommend the best possible part for your application.

Technical assistance and advice is available through a variety of sources:

Phone: 901-795-2400

Toll Free CAM HELP® Line: 1-800-999-0853

Website: www.compcams.com

Email: camhelp@compcams.com

Twitter: @CPGTech

24-Hour Fax: 901-366-1807

Please note that our CAM HELP® line sometimes receives a large volume of calls. Our heaviest call volume is between the hours of 10:00 a.m. to 2:00 p.m. CT. If you experience an undue delay, please try calling during lower volume hours. Email tech questions are normally answered in less than 24 hours.

Goods Damaged in Shipment

All shipments are insured; therefore claims for damage must be made with the freight company. Do not return the merchandise to us unless prior arrangements have been made.

Merchandise Returns

In order to provide better customer service, we require prior approval before a customer returns merchandise for warranty or for other reasons. To obtain an RMA, contact us by one of the means listed above. All merchandise returned to us should be sent freight prepaid and insured, and delivered to the address listed above. Items returned for credit must be in perfect condition.

You must also include inside the package: your name, address, phone number, fax and/or other contact information, along with an explanation of the problem and work to be done. This contact information is important because it allows us to get in touch with you concerning your parts.

Limited Warranty And Limited Lifetime Warranty

Competition Cams, Inc. warrants that its products are free from defects in material and workmanship for a period of **One Year** from the date of purchase. On certain products, there is a Limited Lifetime Warranty. These **Limited Warranties** cover only the original purchaser. Only certain select products that are clearly marked are covered by the **Limited Lifetime Warranty**; all other products carry our **One Year Limited Warranty**.

Competition Cams, Inc.'s obligation under both warranties is limited to the repair or replacement of its product. To make a warranty claim, the part must be returned directly to Competition Cams, Inc. at the address listed below with a valid Return Merchant Authorization Number (RMA), freight prepaid. Items covered under warranty will be returned to you freight collect. To obtain an RMA, call 800-999-0853 to report your issue. When you call the technician, he will also attempt to troubleshoot your issue.

It is the responsibility of the installer to ensure that all of the components are correct before installation. We assume no liability for any errors made in tolerances, component selection or installation.

THERE IS ABSOLUTELY NO WARRANTY ON THE FOLLOWING:

- A) Any part(s) that have not been adequately or properly lubricated;
- B) Any parts used in racing applications or subject to excessive wear;
- C) Any product used in marine applications, unless that product is specifically listed as a marine product;
- D) Any product that has been physically altered, modified, improperly installed or not maintained;
- E) Any product used in an improper application, abused or not used in conjunction with the proper parts.

There are no implied WARRANTIES OF MERCHANTABILITY OR FITNESS FOR A PARTICULAR PURPOSE. There are no warranties which extend beyond the description of the face hereof. **Competition Cams, Inc. will not be responsible for incidental and consequential damages, property damage or personal injury damages.** Where required by law, implied warranties or merchantability and fitness are limited to 90 days from the date of purchase.

This warranty gives you specific legal rights and you may also have other legal rights which vary from state to state.

COMPETITION CAMS, INC.

3406 Democrat Rd. • Memphis, TN 38118 • 901.795.2400



SCAN THE QR CODE TO REGISTER FOR YOUR
COMP CAMS® PRODUCT WARRANTY.

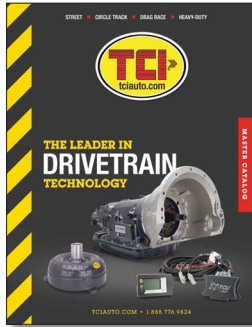

TCI® CATALOG
#999TCI2013-1



FAST™ CATALOG
#F2011-1

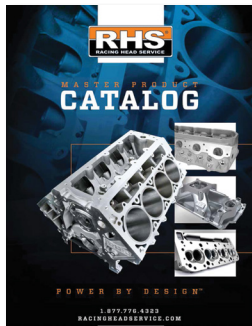

RHS® CATALOG
#RHS5-2013



QUARTER MASTER® HOT PRODUCTS GUIDE
#QM1000-2



ZEX™ CATALOG
#ZEX101-2011



INGLESE™ CATALOG
#NG1821

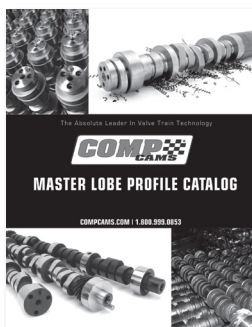

COMP CAMS® MASTER LOBE PROFILE CATALOG
#LC2013



CATALOG ON CD
#COMP107-13



COMP Cams® is a proud member of the COMP Performance Group™ family. To order a printed copy of any COMP Performance Group™ catalog or to view a digital copy online, please visit us at cpgcatalogs.com or scan the QR code to the left.

Want to stay up-to-date on new products, videos, catalogs and more from the COMP Performance Group™ companies? Regardless of whether you're a professional engine builder, a street machine enthusiast, or a writer looking for your next story, keeping up with the latest information from the COMP Performance Group™ has been simplified. CPG Nation™ can provide you with an insider's look at the newest products, and best of all, it's available in several formats. Just look below to find which one best suits your needs.

CPGNATION.com

CPGNation.com contains headlines and other product information from the COMP Performance Group™ brands.

CPG NATION TV™

Browse and watch hundreds of technical videos, installs, new product reviews, dyno tests and company tours.

CPG NATION™ E-Newsletter

Do you prefer to have the news sent directly to you? Sign up today for the CPGNation eNewsletter.



SCAN THE QR CODE
to visit CPGNation.com

COMP Cams® is a proud member of the COMP Performance Group™ family. Other CPG companies include:



tciauto.com
1.888.776.9824



fuelairspark.com
1.877.334.8355



racingheadservice.com
1.877.776.4323



zex.com
1.888.817.1008



inglese.com
1.866.450.8089



powerhouseproducts.com
1.800.872.7223



quartermasterusa.com
1.888.258.8241



raceshopconverters.com
1.888.264.2867



proracingsim.com
901.259.2355

The Cam Series So Advanced

It Could Only Come From COMP Cams®



4-PATTERN CAMSHAFTS

The new 4-Pattern Camshafts are the most advanced hydraulic roller cams COMP® has ever introduced for street/track Small & Big Block Chevy and Small Block Ford engines. These camshafts include technology breakthroughs that collectively deliver gains of 5-20 horsepower and stability up to 7500 RPM without compromising maintenance or durability.

Among the notable design characteristics is the use of four unique lobe patterns on each camshaft. This proven, NASCAR-inspired technology optimizes the valve openings and closings of each cylinder based on the corresponding intake runner length and its flow characteristics. The results are more balanced air/fuel ratios between cylinders than previously possible with conventional, single throttle body or carbureted V8 intake manifolds.

Equally important, these cams are engineered around all-new hydraulic roller lobe designs. **Innovative +.600" lift profiles use fast opening ramps that take full advantage of the latest short travel hydraulic roller lifters, upgraded valve springs and aftermarket cylinder heads.** Meanwhile, tight lobe separation yields more efficient cylinder scavenging and a hard-hitting, hotrod exhaust sound.

Every 4-Pattern Cam is 100% CNC-manufactured on a custom, induction-hardened billet steel cam core (with press-on cast distributor gear) that stops performance killing deflection. Each one also includes an Adcole certification that provides exact measurements for every critical spec.

Put it all together and these street hydraulic roller cams outperform most race solid roller camshafts. 4-Pattern Cams are available for Small & Big Block Chevys (O.E. Rollers & Retro-Fits) and Small Block Fords (O.E. Rollers), carbureted or fuel injected street/track engines.

Engineered To Finish First.



COMPCAMS.COM • CAM HELP® 1.800.999.0853

5-20HP

OVER BEST CAMS
PREVIOUSLY AVAILABLE

CHECK OUT THESE MAJOR TECHNOLOGY ADVANCEMENTS

- 4 Unique Lobe Designs On Each Cam
- All-New Race/Street Hybrid Lobe Series
- New Stronger Steel Billet Cam Core
- 100% CNC Ground With Adcole Cert.

4-PATTERN vs XTREME ENERGY™

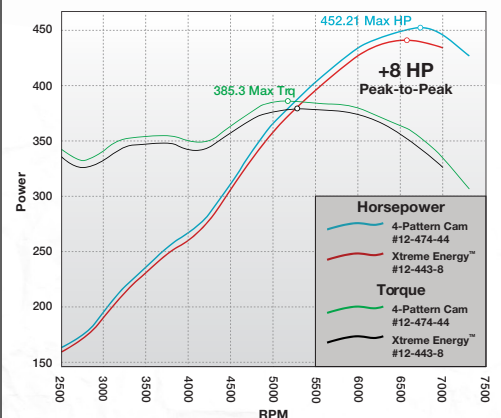

TEST PARAMETERS

Engine: 350c.i. Small Block Chevy, 9.5:1 Compression Ratio

Intake: Aftermarket Single Plane

Carb: 850 CFM Demon

Heads: RHS® Pro Elite™ 228cc CNC-Ported, 69cc Chambers

Valve Springs: COMP Cams® #26926-16

Rocker Arms: COMP Cams® Ultra Pro Magnum #1602-16

Summary of Results: The 4-Pattern Cam outperformed the Xtreme Energy™ Cam throughout the whole range, with peak-to-peak gains of eight horsepower. The 4-Pattern Cam was much more stable at high RPM and had a usable range of 1000 RPM more than the best selling Xtreme Energy™ Camshaft.



Scan This QR Code
To Watch A Video On
These Cams

WINNER OF THE SEMA
BEST NEW STREET
PERFORMANCE
PRODUCT AWARD



RETAINERS
CAMSHAFTS
RACING
TECHNOLOGY
LIFTERS
HORSEPOWER
TORQUE
VALVE SPRINGS
PUSHRODS
QUALITY
VALVE TRAIN
PERFORMANCE
ROCKER ARMS
MUSCLE CAR
HOT ROD
CAMSHAFTS
RACING
TECHNOLOGY
LIFTERS

THE ABSOLUTE LEADER IN VALVE TRAIN TECHNOLOGY

For more than 35 years, COMP Cams® has prided itself on serving as the preferred valve train partner of racers, engine builders and enthusiasts the world over. Whether the company is working with a professional race team or a weekend mechanic, its commitment to building the highest-quality components and providing unparalleled customer service is unwavering.

COMP Cams® employs the aftermarket's largest and most highly trained engineering staff, and its technicians provide a wealth of knowledge unrivaled in the performance aftermarket. Combine the best people with the best resources available in the fields of development, testing and manufacturing, and you have the recipe that makes COMP Cams® The Absolute Leader In Valve Train Technology.



COMP CAMS®

3406 DEMOCRAT RD
MEMPHIS, TN 38118

WWW.COMPCAMS.COM

PHONE: 901.795.2400
TOLL FREE: 1.800.999.0853
FAX: 901.366.1807

PART #106-13

AVAILABLE @

WWW.COMPCAMS.COM